

SAFETINEX

SAFETY LIGHT CURTAINS

TYPE 4

YBES SERIES

INSTRUCTION MANUAL

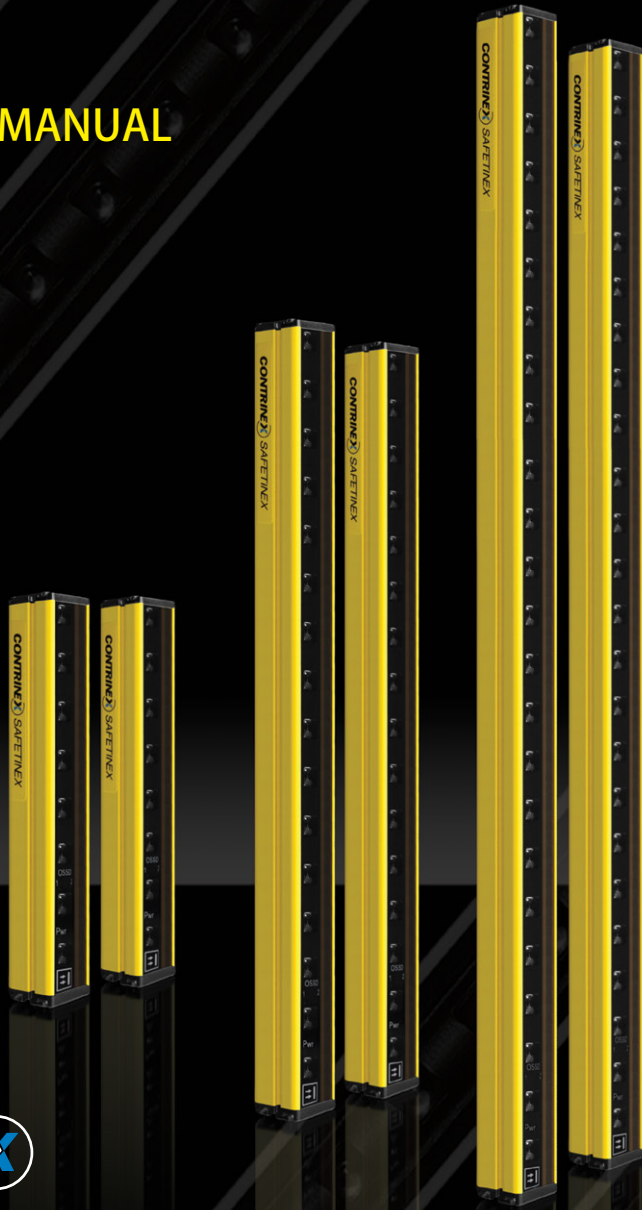

ORIGINAL INSTRUCTIONS

EN – This manual is available to download from our website in many language versions, including **English**:

DE – Diese Bedienungsanleitung steht auf unserer Internetseite in vielen Sprachversionen, darunter **Deutsch**, zum Download bereit:

FR – Ce manuel est téléchargeable depuis notre site internet en plusieurs versions linguistiques, dont le **français** :

IT – Questo manuale è scaricabile dal seguente sito web in diverse versioni linguistiche, tra cui l'**Italiano**:

ES – Este manual está disponible para su descargar desde nuestro sitio web en varios idiomas, incluyendo el **español**:

PT – Este manual está disponível para descarregar a partir do nosso sítio *Web* em muitas línguas, incluindo o **português europeu**:

BR – Este manual está disponível para download no nosso website em vários idiomas, incluindo o **português do Brasil**:

<https://www.contrinex.com/download> – Section “Safety User Manuals”

TABLE OF CONTENTS

1.	INTRODUCTION	5
1.1.	Contrinex.....	5
1.2.	Safetinex safety systems	5
1.3.	Active optoelectronic protective devices (AOPD)	5
1.3.1.	Safeguarding function	6
1.3.2.	Hazardous area	6
1.3.3.	AOPD detection capability	6
1.4.	Advantages of AOPDs	7
1.5.	Operating principle	7
1.6.	Certification of Safetinex products.....	8
2.	EUROPEAN SAFETY STANDARDS	8
2.1.	Types of safety standards applicable in the EU	8
2.2.	Examples of safety standards.....	9
2.3.	An approach to European standards	10
2.4.	The user side	10
2.5.	Machine manufacturer side	11
2.6.	Notified bodies.....	11
3.	NORTH AMERICAN SAFETY STANDARDS	12
3.1.	A different approach	12
3.2.	OSHA Regulations and U.S. Consensus Standards	12
3.3.	North American Standards for safety issues: UL, ANSI and CSA	13
3.3.1.	American standard agencies	13
3.3.2.	Canadian standard agencies	14
3.4.	International standard agencies	14
4.	RISK ASSESSMENT	15
4.1.	Definition of hazards and risk reduction strategy	15
4.2.	Risk assessment process	15
4.3.	Methods for determination of risk level.....	18
4.3.1.	Determination of risk level in North America	18
4.3.2.	Determination of required performance level (PLr).....	18
4.3.3.	Specific standards for safety distance calculation.....	20
5.	INSTALLATION	20
5.1.	Installation rules	20
5.1.1.	Positioning the AOPD	20
5.1.2.	Minimum Safety Distance required.....	21
5.1.3.	Minimum safety distance calculation (EU)	22
5.1.4.	Minimum safety distance calculation (US and Canada)	24
6.	OTHER COUNTRIES	25
7.	ACRONYMS	26
8.	TECHNICAL DOCUMENTATION	27
8.1.	Safetinex YBES for hand protection.....	27
8.2.	Safetinex YBES for finger protection.....	27
8.3.	Advantages of the Safetinex range	27

8.4.	Scope of this technical documentation	28
8.5.	Self protected outputs.....	28
8.6.	Resolution (R) of an AOPD	29
8.7.	LED status indicators	30
8.7.1.	Test mode selection.....	31
8.8.	Installation	31
8.8.1.	Minimum safety distance.....	31
8.8.2.	Positioning the sender and receiver units	32
8.8.3.	Distance from reflective surfaces	33
8.8.4.	Installation of multiple systems.....	34
8.8.5.	Mechanical installation	35
8.8.6.	Mounting with bracket No. 5 (standard bracket).....	36
8.8.7.	Mounting with bracket No. 6 (optional bracket).....	37
8.8.8.	Mounting with bracket No. 7 (optional bracket).....	38
8.8.9.	L-shaped installation	39
8.8.10.	Twin installation and resolution at the end of the light curtain.....	39
8.8.11.	No blind zone capability.....	40
8.9.	Technical specifications.....	41
8.9.1.	Available models YBES	41
8.9.2.	Technical data YBES	43
8.10.	Connecting the protective device.....	45
8.10.1.	Power supply	45
8.10.2.	Electromagnetic compatibility (EMC).....	45
8.10.3.	Light radiation.....	45
8.10.4.	Pin assignment for YBES series	46
8.11.	Safetinex safety relay YRB-4EML-31S	47
8.11.1.	Response time from protective field intrusion to switching of safety relay	47
8.11.2.	Connection examples for YRB-4EML-31S safety relay	48
8.12.	Connection cables.....	49
8.13.	Alignment of sender and receiver units.....	50
8.14.	Test before the first commissioning	53
9.	TESTING AND MAINTENANCE	53
9.1.	Daily functional test.....	53
10.	SPECIAL FUNCTIONALITIES.....	54
10.1.	External Device monitoring (EDM).....	54
10.2.	Automatic or Manual restart (restart interlock)	55
10.3.	Beam Coding.....	56
10.4.	Diagnostics	56
10.5.	Preparation of the configuration	56
10.6.	Troubleshooting	57
10.7.	Preventive periodic inspections.....	58
10.8.	Cleaning.....	58
10.9.	Daily testing log file.....	58
11.	CERTIFICATIONS.....	60
12.	DISCLAIMER	61
13.	EC DECLARATION OF CONFORMITY.....	63

1. INTRODUCTION

1.1. CONTRINEX

Contrinex, a multinational company with headquarters in Switzerland, is specialized in the development, production and worldwide sales of position sensors, RFID and safety systems. Contrinex employs over 500 people, including 25 highly qualified R&D engineers, operates production units in Switzerland, China, USA, Sri Lanka and Brazil, has its own sales offices in all the major markets and is represented in over 60 countries. Contrinex applies stringent management and production principles, which are reflected in its ISO 14001:2004 and ISO 9001:2008 certifications. Additionally, Contrinex is subject to regular client-based audits. Identical quality controls and equipment as well as staff recruitment and training policies are implemented at the different production sites, thus guaranteeing consistent product quality.

1.2. SAFETINEX SAFETY SYSTEMS

The Safetinx product lines produced by Contrinex offer high quality safeguarding solutions for both personnel and machinery. Our specialists in sensor technology have developed high-performance electro-sensitive protective equipment. Our range of safety products comprises highly sensitive devices for finger and hand protection as well as access control, featuring various lengths and connection options.

Safetinx products have been developed in compliance with the applicable international safety standards and have obtained the required product certification for use in the European Union, the United States of America and all other countries where the applicable IEC standards have been adopted.

1.3. ACTIVE OPTOELECTRONIC PROTECTIVE DEVICES (AOPD)

When looking to build a safety system around a danger zone, the first consideration is whether or not optical protection is suitable at all. For this to be the case, it must be possible for the machine control to be electrically influenced by means of the AOPD's semiconductor output. Moreover, it must also be possible to instantly terminate or exit the hazardous process in every operating phase. Further, there must be no danger of injury due to heat, radiation or from materials or components ejected by the machine. If such danger exists, then either the optical system is not suitable, or the danger must be otherwise excluded by applying additional safety measures.

The selection of a specific type of safeguard involves an evaluation of the hazard, in order to determine the applicable category or required performance level PLr.



The choice of an active optoelectronic protective device (AOPD), such as a safety light curtain, depends on:

- The relevant safety standards to be applied
- The definition of the safeguarding function
- The available space around the hazardous area
- The safety distance, as calculated by the appropriate formula and depending on the AOPD's resolution and position, as well as the response times of the light curtain, the safety relay and the machine stopping time
- Ergonomic factors (e.g. how often access is necessary)
- Commercial criteria

1.3.1. SAFEGUARDING FUNCTION

The AOPD resolution must be chosen according to the application and the required safeguarding function. It is defined as the minimum size of an object that can be reliably and safely detected at any position in the protective field.

Point of operation: detection of hands entering the defined hazardous area. The protective equipment immediately stops the machine or renders it harmless. The Safetinex YBES range is best suited for this type of application.

The primary function of the protective device is to stop the machine before the hazardous point is reached and to prevent unintentional machine start-up or restart. This function must comply with the category or performance level of the safety-related components of the machine's control system.

1.3.2. HAZARDOUS AREA

The hazardous area can be defined in terms of:

- The dimensions of the zone that requires protection
- The different access points to accessible hazards
- The risk of an undetected presence in the hazardous zone, or risk of bypassing the protective device

1.3.3. AOPD DETECTION CAPABILITY

The light curtain or barrier detection capability (or resolution) depends on the distance between the centerlines of each beam emitted by the sender. The choice for a specific resolution depends on the part of the body which needs protection.

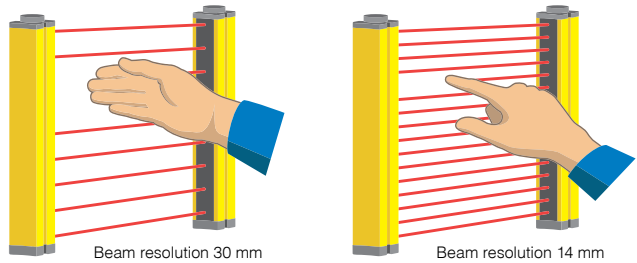

FIG. 1: RESOLUTION OF THE LIGHT CURTAINS

1.4. ADVANTAGES OF AOPDs

Safeguarding devices are used where risks cannot be eliminated by machine design. Rather than preventing access to a hazardous area, safety light curtains detect the entry of a person or part of a body and eliminate the hazard by triggering an immediate stop of the hazardous machine motion. They present several advantages over mechanical safeguarding devices:

- Access time to the machine is reduced, thereby increasing productivity
- Workplace ergonomics are greatly improved and less space is required
- The invisible infrared beams allow better visibility of the machine and operating process
- Protection applies to any approaching person

1.5. OPERATING PRINCIPLE

A light curtain comprises two units, namely a beam sender (or transmitter) and a receiver between which coded infrared beams are sequentially exchanged. The protective field is the area enclosed by these two components, the emitted light beams forming a permanent, though invisible, shield between the two units. The receiver unit is connected to a safety relay which transmits the signal to the machine control unit.

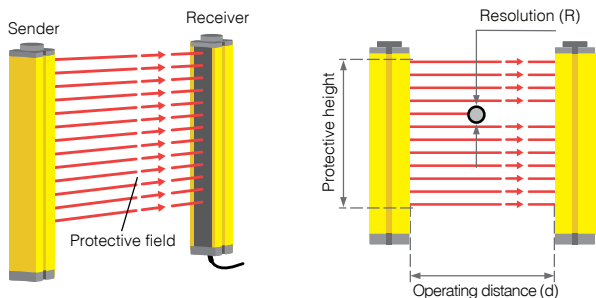

FIG. 2: OPERATING PRINCIPLE

Synchronization between the sender and receiver devices is performed optically, i.e. wired connection between the two units is not necessary.

When properly installed, the protective device detects any relevant entry into the hazardous area. As soon as such an entry is detected, the protective device immediately triggers the safety relay, which in turn causes the machine control system to bring the machine to a safe status and/or complete stop, thus eliminating the hazard. Any internal fault is detected by the device's permanent self-control function and has the same result as an intrusion into the protective field.

The size of the protective field depends on the dimension of the AOPD and the distance between the sender and receiver units.

AOPDs are also commonly used as sensors to automate industrial operations where no critical human safety issue is involved. However, when directly linked to the safety of persons, their design and installation are strictly regulated.

1.6. CERTIFICATION OF SAFETINEX PRODUCTS

Safetinx YBES products satisfy all the requirements of category 4, PL e, according to EN/ISO 13849-1 (formerly EN 954-1), type 4 according to EN/IEC 61496-1 and -2 and SIL 3 according to EN/IEC 61508.

Before considering the use of Safetinx products in machine safety applications, it must be verified that the product certifications are valid in the country where the product is to be used.

The following chapters provide a brief introduction to the main standards and regulations applicable in the European Community and in North America. They are by no means a complete guide and only serve as a reminder of the most important issues. For detailed information, please refer to the original documents.

2. EUROPEAN SAFETY STANDARDS

This section is intended to provide help for designers and users of industrial machinery. It summarizes the basic principles of European directives, procedures and regulations in terms of protection against hazards in the work environment. It is by no means a complete guide and only serves as a reminder of the most important issues. For detailed information, please refer to the original documents.

2.1. TYPES OF SAFETY STANDARDS APPLICABLE IN THE EU

In the European Union, safety is legislated. The EU's Machinery Directive requires that all machines and safeguarding devices operating in EU countries meet essential safety standards. Harmonized European standards regarding machine safety policies are prepared by the CEN (European Committee for Standardization) or CENELEC (European Committee for Electrotechnical Standardization) and finalized by the EU Commission. Once ratified, these standards become European Standards

(EN) that take precedence over national laws. Thus, EU countries must remove or modify any national standard that conflicts with the European Standard. CENELEC and CEN cooperate closely with ISO and IEC, the main bodies for international standards.

Applicable standards usually have the prefix EN (“European Norm”), but most also have international – ISO/IEC – equivalents. There are different types of standards:

- A-type standards are basic safety standards applicable to all machinery, e.g. EN/ISO 14121
- B1-type standards set out special safety aspects and procedures, e.g. EN/ISO 13849-1
- B2-type standards set rules on safety equipment design, e.g. EN/IEC 61496-1, EN/TS/IEC 61496-2/-3
- C-type standards set safety requirements for a specific machine or type of machine

2.2. EXAMPLES OF SAFETY STANDARDS

In addition to the Machinery Directive 2006/42/EC and the Work Equipment Directive 2009/104/EC, there are standards that specifically focus on protective equipment, such as:

TYPE	SCOPE	EUROPEAN STANDARDS	INTERNATIONAL STANDARDS
A	Safety of machinery Basic principles	EN 12100-1 EN 12100-2	ISO 12100-1 ISO 12100-2
	Risk assessment	EN 14121-1 EN 14121-2	ISO 14121-1 ISO 14121-2
B	Interlocking devices	EN 1088	ISO 14119
	Guards	EN 953	
	Safety related parts of control systems	EN 13849-1 EN 13849-2	ISO 13849-1 ISO 13849-2
	Safety of machines: Electro-sensitive protective equipment	EN 61496-1 EN 61496-2 EN 61496-3	IEC 61496-1 IEC 61496-2 IEC 61496-3
	Safety distance details	EN 13855	ISO 13855
	Positioning of protective equipment	EN 13855	ISO 13855
	Functional Safety	EN 61508 1-7	IEC 61508 1-7

TABLE 1: EXAMPLES OF SOME APPLICABLE SAFETY STANDARDS

For additional information regarding European standards, please refer to www.din.de, www.iec.ch, www.iso.org.

2.3. AN APPROACH TO EUROPEAN STANDARDS

The European Union has chosen to regulate the production, installation and use of old, modified and new machines within the European Union territory by approaching the parties concerned separately, i.e. one legal framework has been created for users and another for manufacturers.

The Work Equipment Directive sets out the rules applying to users of machines on production sites, while the Machinery Directive sets out those applying to machine constructors and safety equipment manufacturers. However, most subordinate standards apply to both parties, as shown in the following chart.

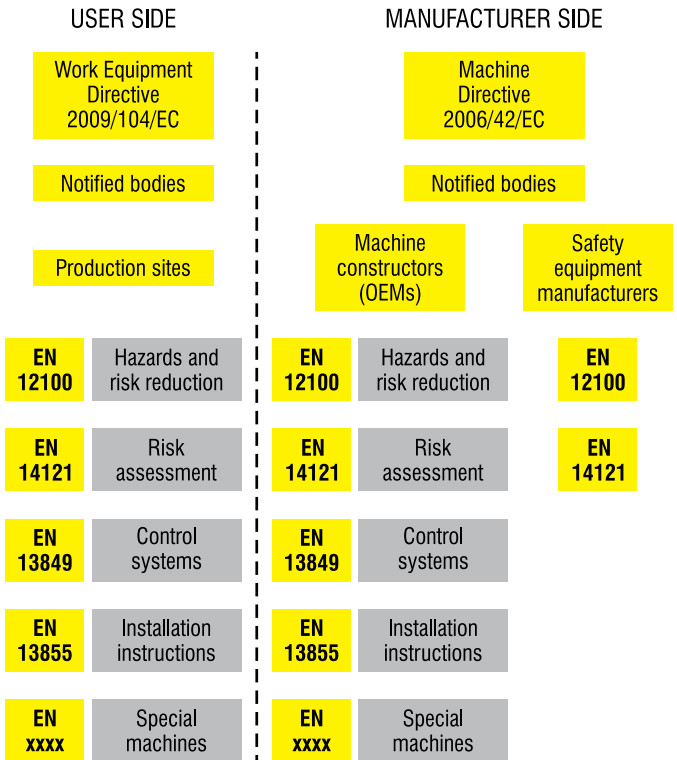

TABLE 2: EUROPEAN MACHINE SAFETY OVERVIEW – USER AND MANUFACTURER SIDE

2.4. THE USER SIDE

The user side is regulated by the Work Equipment Directive, which states that users of a machine are obliged to make sure that it complies with the legal requirements. Hence, if the user buys a machine which does not comply with the EU Machinery Directive, it is his responsibility to take the necessary actions to bring the machine up to the required quality and safety level.

Additionally, the Work Equipment Directive specifies what minimum regulations must be observed for safety purposes when work equipment is being used. The original text can be found on the relevant European Union website.

2.5. MACHINE MANUFACTURER SIDE

The manufacturer side is addressed by the Machinery Directive. This umbrella document refers to the specific requirements described in EN standards, and stipulates that each danger zone of a machine must be made safe. The method used to make different zones safe depends on the type of hazard.

The Machinery Directive requires that, before placing machinery on the market and/or putting it into service, the manufacturer ensures that a technical file is made available. This technical file shall comprise a construction file including, among others: “the documentation on risk assessment demonstrating the procedure followed, including:

- (i) a list of the essential health and safety requirements which apply to the machinery,
- (ii) the description of the protective measures implemented to eliminate identified hazards or to reduce risks and, when appropriate, the indication of the residual risks associated with the machinery.” (Machinery Directive 2006/42/EC, Annex VII, A, 1, a)

Machines that are highly hazardous (as listed in Annex IV of the Machinery Directive) must conform to special procedures. The manufacturer is responsible for obtaining conformity through various procedures that may require examination of the machine by an EU notified body.

2.6. NOTIFIED BODIES

In order to have control over the execution of these directives, verification of certain steps by certifying bodies may be imposed by the directives. For example, all safety device concepts must be analyzed, checked and tested by such a third party organization. In many cases, this third party organization also audits the production process of a safety device manufacturer.

A notified (or certified) body is a certification, inspection or testing body designated by the notifying authority of an EU member state to issue attestations of conformity for products. Each EU member state has a list of notified bodies authorized to issue EU-type examination certificates. The lists include the identification number of each notified body, as well as the specific areas of activity and the tasks for which it has been designated.

European notified bodies responsible for carrying out conformity assessment procedures can be found through the NANDO (New Approach Notified and Designated Organizations) website, where accredited bodies can be searched for by country, product or directive. An official list of notified bodies responsible for assessing products in compliance with the Machinery Directive can also be found on the relevant European Union website.

3. NORTH AMERICAN SAFETY STANDARDS

This section is intended to provide help for designers and users of industrial machinery. It summarizes the basic principles of North American regulations and standards in terms of protection against hazards in the working environment. It is by no means a complete guide and only serves as a reminder of the important issues. For detailed information, please refer to appropriate agencies and documents.

3.1. A DIFFERENT APPROACH

Whereas European standards are mainly machine manufacturer oriented, North American standards are primarily directed towards users. Unlike in the EU, third party certification is not mandatory in the US or Canada. In terms of liability, it is the employer's responsibility to prove that he has done his utmost to ensure his employees' safety. However, certification has become a strong commercial asset in terms of market requirement. On users' request, national compliance agencies assess and grant the required certification.

Although the US and the EU have different methods for developing and applying standards, their purpose is the same, namely to ensure an appropriate level of safety in the workplace. Harmonized standards have the advantage of promoting world trade and reducing duplication of effort. Harmonized international standards allow manufacturers to access many markets with one product. Users profit from competitive products that meet uniform quality and functional requirements – wherever they were manufactured.

In the United States, standards are developed and enforced both by governmental agencies and industry groups. US employers, installers or OEMs are legally responsible for compliance with all applicable regulations, both national and international. In the US, the Occupational Safety and Health Administration (OSHA) is a federal agency that can enforce its regulations through penalties and fines.

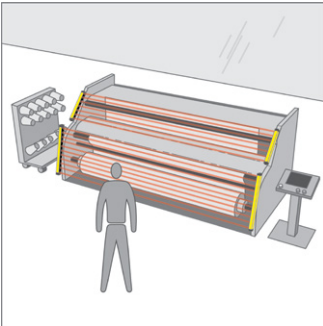

FIG. 3: APPLICATION EXAMPLE OF YBES DEVICES

3.2. OSHA REGULATIONS AND U.S. CONSENSUS STANDARDS

The Occupational Safety and Health Act passed on Dec. 29, 1970 established guidelines for safe and healthy working conditions.

Occupational Safety and Health Standards in the U.S. are defined in Title 29 of the Code of Federal Regulations Part 1910. Subpart O of this document deals specifically with machinery and machine guarding, and defines the general requirements for all machines (1910.212) and for some specific types of machinery.

Encouraged and assisted by OSHA, more than half of the US states have developed their own safety and health programs and regulations which are then enforced by OSHA as “National Consensus Standards”. Information on both state plans and OSHA regulations may be obtained from their respective websites.

OSHA uses national consensus standards to further define machine protection requirements in addition to subpart O. In 1910.212, it states: “The

point of operation of machines whose operation exposes an employee to injury, shall be guarded. The guarding device shall be in conformity with any appropriate standards therefore, or, in the absence of applicable specific standards, shall be so designed and constructed as to prevent the operator from having any part of his body in the danger zone during the operating cycle.”

“Any appropriate standards” refers to national consensus standards generally recognized in the industry. Bodies frequently referenced by OSHA include the American National Standards Institute (ANSI), the National Fire Protection Agency (NFPA), Underwriters Laboratories (UL) and the American Society of Mechanical Engineers (ASME).

As an example, ANSI B11.1 sets safety requirements for mechanical power presses, ANSI B11.15 specifies standards for pipe bending machines, ANSI B11 TR.1 gives ergonomic guidelines for the design, installation and use of machine tools, and ANSI/RIA R15.06 stipulates the safety requirements for industrial robots. Please consult national consensus standards bodies for complete listings.

3.3. NORTH AMERICAN STANDARDS FOR SAFETY ISSUES: UL, ANSI AND CSA

3.3.1. AMERICAN STANDARD AGENCIES

UL STANDARDS

Underwriters Laboratories Inc. is a testing organization established in 1894 and is authorized to conduct certification testing of any electrical device. Although UL certification is not mandatory, many companies strive to obtain its certification for products aimed at the U.S. market.

UL certification has two levels, namely listing certification, generally for final products, and recognition certification, for parts or components built into a product. Once a product has obtained UL certification, additional on-site inspections are carried out on a quarterly basis to ensure that the production plant continues to manufacture products conforming to UL standards.

Since the purpose of UL standards is to eliminate the danger of fire or electric shock caused by electrical appliances, in principle only those appliances presenting such risks are subject to this certification.

For more details on the UL Standards, please consult the UL website.

ANSI STANDARDS

The American National Standards Institute was founded in 1918 to manage the standardization system in the US. It is not ANSI's task to create standards of its own, but rather to approve the standards set up by specialized organizations. Many UL standards have been converted into ANSI/UL standards.

For instance, ANSI standards include ANSI B 11.19: Standard for performance of safeguarding devices and ANSI/RIA R15.06: Standard for robot safety.

For more details on the ANSI Standards, please visit the ANSI website.

3.3.2. CANADIAN STANDARD AGENCIES

CSA STANDARDS

The Canadian Standards Association is an organization that administers and coordinates the standardization system in Canada. Cross-certification between the U.S. and Canada has been granted, based on the Mutual Recognition Agreement (MRA).

Electrical appliances connected to a public power source in Canada must conform to CSA Standards. Manufacturers of these products need to obtain C-UL or CSA certification, or the seller needs to apply for certification directly to the provincial authorities.

For more details on the CSA Standards, please visit the CSA website.

3.4. INTERNATIONAL STANDARD AGENCIES

International standards also play a significant role in North American machine safety. The two main international entities are the International Electrotechnical Committee (IEC) and the International Standards Organization (ISO). IEC is a recognized provider of standards in the electrotechnical field and is composed of national electrotechnical committees. ISO is an international federation of national standardization bodies. ISO and IEC influence international standards through formal relationships. In the US, ANSI coordinates with ISO and IEC through technical advisory groups (TAG).

4. RISK ASSESSMENT

4.1. DEFINITION OF HAZARDS AND RISK REDUCTION STRATEGY

EN/ISO 12100

EN/ISO 12100 serves as a basis for all subsequent standards. It describes every type of hazard that needs to be considered in terms of machine safety. Exposure to hazards includes numerous potential situations that must first be identified.

Mechanical hazards may result in crushing, shearing, cutting/severing, entanglement, drawing-in/trapping, impact, stabbing/puncture, friction/abrasion, injuries due to high pressure fluid ejection, etc. Machine hazards are also influenced by sharp edges, vibrations and unstable or moving objects. The list quotes electrical and thermal hazards, radiation, dust and hazardous substances (gas, vapors). In terms of ergonomics and the working environment, there are risks of falling, tripping or slipping. A combination of hazards may result in a specific new hazard.

EN/ISO 12100 subsequently gives general guidelines for eliminating or reducing hazards through prevention and protection. It is recommended to use technology that avoids most of the problems linked with the hazards listed above. Any decision that contributes to prevention against hazards is part of the security process and risk reduction strategy.

In this respect, taking ergonomic principles into consideration is important. A high level of automation will not only help operators, it will also increase productivity and reliability. Reducing unnecessary human movements and efforts can contribute to a safer working environment. Proper lighting of the work place will help to minimize hazards.

Operators must be able to stop machines at any time in case of an emergency. Starting and/or restarting the machine after an interruption must be carefully planned. When programmable electronic safety systems are used, the behavior of such systems in case of defect and the protection of the software requires particular attention.



4.2. RISK ASSESSMENT PROCESS

In essence, conducting a risk assessment involves identifying hazards, evaluating the potential severity of harm and identifying measures and solutions for eliminating or reducing such risks.

This requirement is stated in U.S. standards (Title 29 US Code of Federal Regulations, Part 1910, Subpart O).

For more details, please refer to the following documents:

- OSHA 3071, Job Hazard Analysis
- ANSI/RIA R15.06-1999, Safety Requirements for Industrial Robots and Robot Systems
- ANSI B11.TR3, Risk Assessment and Risk Reduction
- EN/ISO 14121, Principles of Risk Assessment. EN/ISO 14121 refers to additional standards, such as EN/ISO 13849-1 and EN/ISO 12100

The following chart, based on EN/ISO 12100-1 and ANSI B11.TR3:2000, can be used to carry out risk analyses and ensure that all issues have been thoroughly considered. This iterative process must be carried out for every machine operating in the work place, as well as for all the potential hazards associated with each machine.

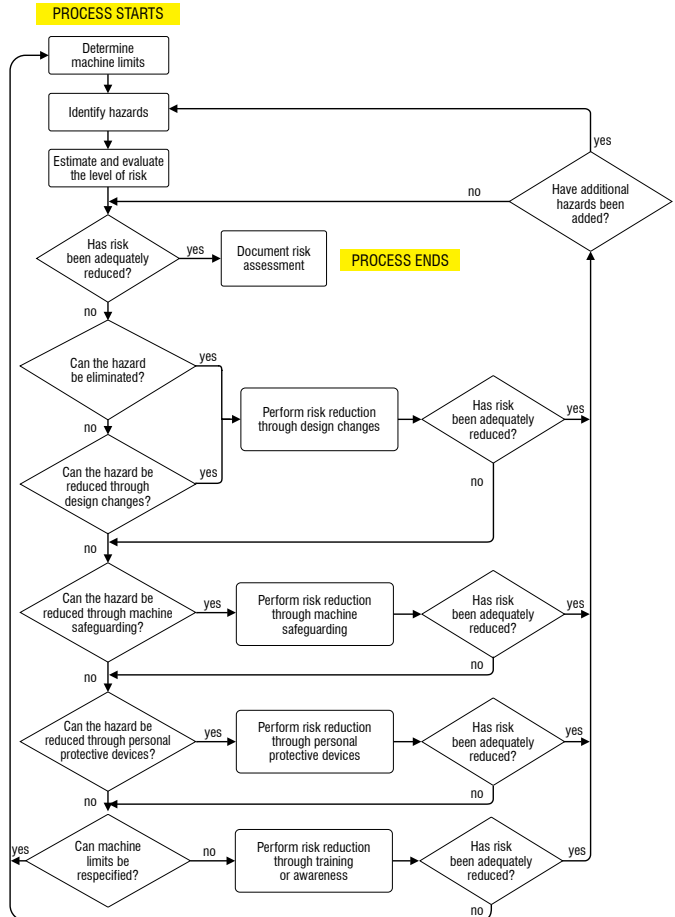

DIAGRAM 1: RISK ASSESSMENT PROCESS

This risk analysis and assessment process helps to take all the different aspects of potential machine hazards into consideration. It is important to document this procedure as evidence that the task has been fully carried out and to allow others to check it or use it for further improvements.



EN/ISO 14121 also describes procedures for identifying hazards and assessing risks, and provides guidance on the information required to achieve this goal. The process involves analyzing the risks in a systematic and documented way, in order to eliminate or reduce hazards. Qualitative and quantitative methods can be used.

All aspects of potential hazards must be taken into consideration:

- The phases of a machine's life
- The full range of foreseeable uses and misuses of a machine
- All persons possibly exposed to hazards when the machine is being used

Risk is defined as a function of the severity of possible harm and the probability that such harm occurs (frequency and duration of exposure, possibility of avoiding harm, etc.). One important piece of information is the history of accidents, if available.

Among the aspects to be considered when establishing elements of risk, the analysis should account for

- Different types of exposure depending on the type of work (setting, teaching, operating, cleaning, etc.)
- Human factors, such as applicability and ergonomic issues
- The reliability of safety functions, including their maintenance
- The possibility to defeat or circumvent safety measures

EN/ISO 14121-1:2007 gives a full list of hazards referenced by EN/ISO 12100.

In addition, the safety of any machine will diminish with time due to the deterioration of components, wear, loosening of parts, etc. It is therefore important to conduct regular inspections in order to detect defects that may lead to reduced safety, and to effect the necessary repairs before the level of risk exceeds the original assessment.



4.3. METHODS FOR DETERMINATION OF RISK LEVEL

The methods used for assessing the risks associated with a specific machine are addressed by several standards. Standards either impose or recommend corrective measures that will establish an adequate level of safety.

4.3.1. DETERMINATION OF RISK LEVEL IN NORTH AMERICA

In order to select the appropriate safety device adapted to the actual risks and dangers, it is important to assess the risk. ANSI B11.TR3-2000 provides a “Risk Estimation Matrix” in order to determine the level of risk depending on the cross-referenced factors of the probability of harm occurrence and harm severity:

PROBABILITY OF HARM OCCURRENCE	SEVERITY OF HARM			
	CATASTROPHIC	SERIOUS	MODERATE	MINOR
Very Likely	High	High	High	Medium
Likely	High	High	Medium	Low
Unlikely	Medium	Medium	Low	Negligible
Remote	Low	Low	Negligible	Negligible

TABLE 3: RISK ESTIMATION MATRIX AS PRESENTED BY ANSI B11.TR3-2000

The purpose of assessing the risk is to determine the appropriate level of safety. It is important that the protective device complies with the determined risk and is adapted to the machine control system. Risk assessment applies to each element that makes up the safety system, and not just the protective device itself. In particular, safety devices can only be used on machines that comply with control reliability as described in OSHA 29.1910.212 and ANSI B11.19-20.



Another important point to be considered is the life cycle of the machine and its protective devices. The safety of any machine will diminish with time due to the deterioration of components, wear, loosening of parts, etc. It is therefore important to conduct regular inspections in order to detect defects that may lead to reduced safety, and to effect the necessary repairs before the level of risk exceeds the original assessment.

4.3.2. DETERMINATION OF REQUIRED PERFORMANCE LEVEL (PLr)

EN/ISO 13849-1 sets out a procedure for the selection and design of safety measures. The procedure contains the following 6 steps:

1. Identify the safety functions to be performed
2. Determine the required Performance Level
3. Design and technical realization of the safety functions
4. Evaluate the achieved Performance Level
5. Verify the achieved Performance Level
6. Validate that all requirements are met

EN/ISO 13849

Based on risk identification, the required performance level of risk reduction is determined using the following graph sourced from EN/ISO 13849-1, Annex A.

The objective is to determine the required performance level PLr that sets the requirements of the necessary safety system, depending on the risks involved in each case. As described below, three parameters are taken into consideration:

1. The potential severity of the harm
2. The frequency and/or duration of exposure to the hazard
3. The possibility of avoiding the hazard

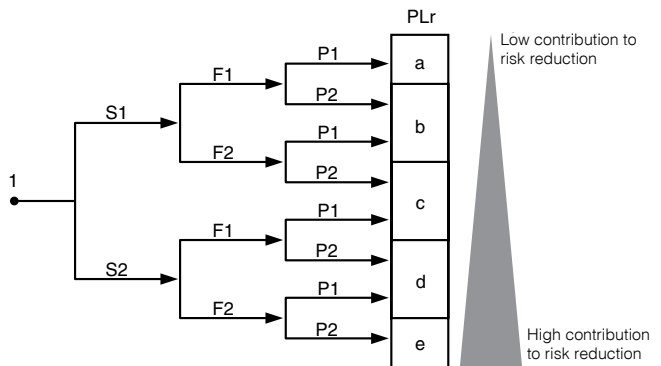

- 1 Starting point for evaluation of safety function contribution to risk reduction
- S Severity of injury:
 - S1 Slight (normally reversible injury)
 - S2 Serious (normally irreversible injury or death)
- F Frequency and/or exposure to hazard:
 - F1 Seldom-to-less-often and/or exposure time is short
 - F2 Frequent-to-continuous and/or exposure time is long
- P Possibility of avoiding hazard or limiting harm:
 - P1 Possible under specific conditions
 - P2 Scarcely possible
- PLr Required performance level

DIAGRAM 2: REQUIRED PERFORMANCE LEVEL

In order to reduce the determined risk (PLr) to an appropriate level, a safety system with performance level $PL \geq PLr$ needs to be properly implemented. A corresponding average probability of dangerous failure per hour (PFH_D) can be associated with each performance level:

PERFORMANCE LEVEL (PL)	AVERAGE PROBABILITY OF DANGEROUS FAILURE PER HOUR
a	$10^{-5} \leq PFH_b < 10^{-4}$
b	$3 \times 10^{-6} \leq PFH_b < 10^{-5}$
c	$10^{-6} \leq PFH_b < 3 \times 10^{-6}$
d	$10^{-7} \leq PFH_b < 10^{-6}$
e	$10^{-8} \leq PFH_b < 10^{-7}$

TABLE 4: AVERAGE PROBABILITY OF DANGEROUS FAILURE PER HOUR

All Safetinex type 4 AOPDs fully comply to Performance Level e. For details, please consult the product data sheet.

4.3.3. SPECIFIC STANDARDS FOR SAFETY DISTANCE CALCULATION

EN/ISO 13855 gives details concerning the positioning of safeguards with respect to the approach speeds of parts of the human body.

EN/ISO 13855



5. INSTALLATION

5.1. INSTALLATION RULES

All safety equipment has to be installed following the strict installation instructions given by the manufacturer and the applicable standards. Without proper installation, the safety device cannot fulfill its function and will give a false impression of safety to persons approaching a dangerous machine. EN/ISO 13855 defines the installation requirements for safety light curtains with respect to the approach speeds of parts of the human body. Below is a summary of the key concepts.

EN/ISO 13855



5.1.1. POSITIONING THE AOPD

The level of safety depends on the way the device is positioned. The risk assessment conclusions will help decide what position is best suited for preventing foreseeable hazards. In order to ensure proper safeguarding, special care must be taken to find the position that will not allow the protective device to be bypassed and such that any hazardous machine movement is safely stopped before potential harm occurs.



There are different classical ways to position safety light curtains:

- Vertically (perpendicular approach)
- Horizontally (parallel approach)
- In an L shape (combined perpendicular and parallel approach)
- Inclined (angular approach).

It must not be possible to pass over, below, around or go behind the protective field. When positioning light curtains it must not be possible to pass over the highest beam, below the lowest beam or between two beams. If this cannot be guaranteed, then additional protective devices must be used.



FIG. 4: POSITIONING THE LIGHT CURTAIN

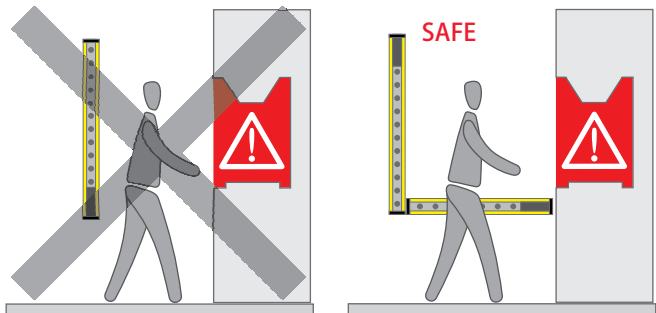

For practical details on L-shaped installations, please consult the relevant paragraph on page 35 as well as page 39.

5.1.2. MINIMUM SAFETY DISTANCE REQUIRED

Since the principle of light curtains is to detect an intrusion early enough to intervene in the machine cycle before anyone has had time to reach the danger zone, positioning of protective equipment must respect the approach speed of parts of the human body, as well as the total response time of the installed safety system.

The following methodology, based on EN/ISO 13855, can be used to determine the proper minimum safety distance:

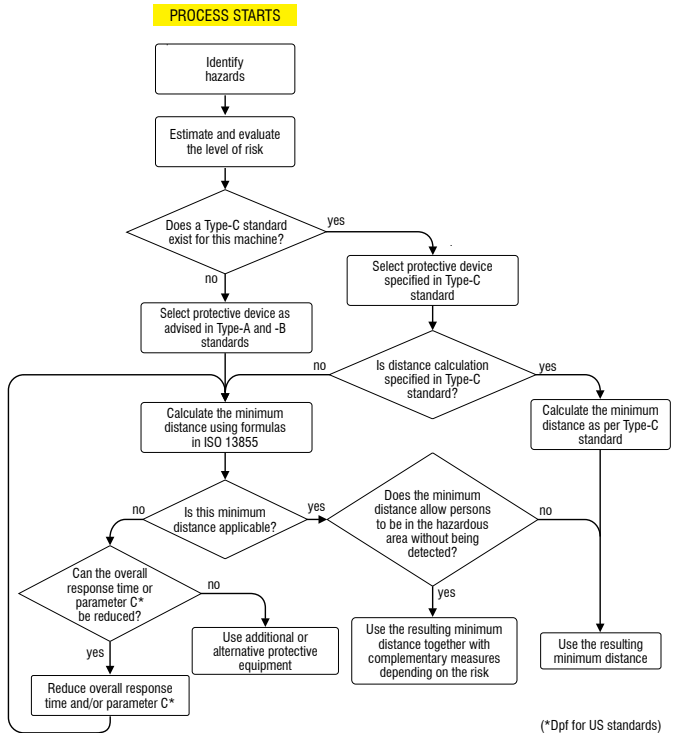

DIAGRAM 3: MINIMUM SAFETY DISTANCE EVALUATION PROCESS

5.1.3. MINIMUM SAFETY DISTANCE CALCULATION (EU)

In the following figures and formulas, the minimum safety distance (S) designates the distance between the beginning of the hazardous area and the protective screen, or the furthest protective beam in case of horizontal positioning of the AOPD.

According to EN/ISO 13855, the minimum safety distance depends on:

1. The approach speed of the body – or part thereof – to be detected
2. The total response time of the safety system:
 - a. Response time of the AOPD
 - b. Response time of the safety control unit
 - c. Machine stopping time (effective stopping of the machine's dangerous movement)
 - d. Any additional response delay
3. Resolution of the AOPD

EN/ISO 13855 defines a basic formula for calculating the minimum safety clearance between the protective device and the hazardous location:

$$S = (K \times T) + C$$

Parameters:

- S: Minimum safety distance between the AOPD sensing field and the hazardous area (mm). Cannot be less than 100 mm.
- K: Average approach speed at which a body or part of a body enters the detection zone (mm/s).
- T: Total response time (seconds), including
 - T_c : Response time of the protective device (in seconds, value provided on manufacturer's data sheet)
 - T_r : Response time of the safety relay (in seconds, value provided on manufacturer's data sheet)
 - T_m : Machine stopping time (in seconds, value provided by manufacturer or measured on request by specialists)
- C: Additional safety distance in mm, which depends on the resolution of the protective device. It cannot be less than zero.
 - R = Resolution of the protective device (mm)
 - C = $8 \times (R - 14 \text{ mm})$ where $R \leq 40 \text{ mm}$ (= 0 when the light curtain has a resolution of 14 mm)
 - C = 850 mm where $40 \text{ mm} < R \leq 70 \text{ mm}$

For a detection resolution $\leq 40 \text{ mm}$, the formula thus becomes:

$$S = K \times (T_c + T_r + T_m) + 8 \times (R - 14 \text{ mm})$$

for a detection resolution $40 \text{ mm} < R \leq 70 \text{ mm}$:

$$S = K \times (T_c + T_r + T_m) + 850 \text{ mm}$$

where

K = 2,000 mm/s*

*if the calculated value of S is $> 500 \text{ mm}$, then recalculate S using

K = 1,600 mm/s

The above calculation formula applies when the protective device is positioned vertically (perpendicular approach) or in case of an angular approach if the angle (β) between the protective field and the direction of entry exceeds 30° . S is then the distance from the hazardous point to the closest protective beam.

In the case of horizontal positioning of the protective device (parallel approach) or if the angle between the protective field and the direction of entry is less than 30° , the applicable formula is:

FIG. 5: MINIMUM SAFETY DISTANCE (EU)

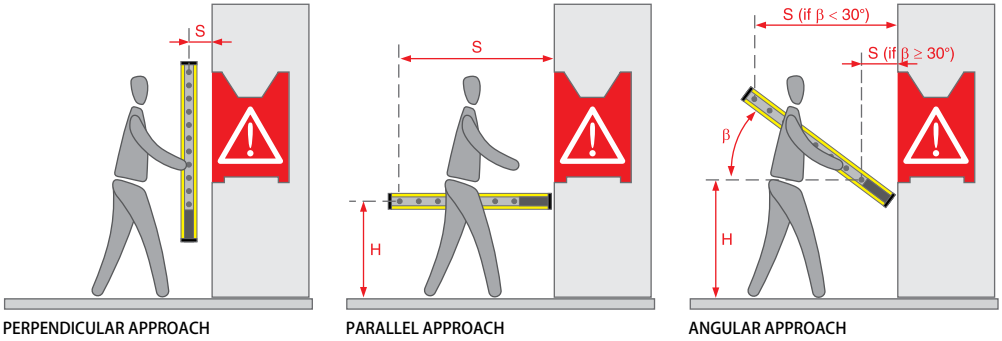

$$S = K \times (T_c + T_r + T_m) + (1,200 \text{ mm} - 0.4 \times H)$$

where

$K = 1,600 \text{ mm/s}$

H : Height of the lowest beam from the floor (max. 1,000 mm).

Here, S is the distance from the hazardous point to the farthest protective beam.

The above calculation guidelines summarize the basic regulations and standards. For details, please refer to the applicable standard.

5.1.4. MINIMUM SAFETY DISTANCE CALCULATION (US AND CANADA)

The general safety distance calculation formula below is given in:

- ANSI B11.19-2003 Annex D Equation 7
- ANSI/RIA R15.06-1999
- CSA/CAN Z142-02
- Code of Federal Regulations (OSHA) Subpart O, Volume 29 Part 1910.217 (h) (9) (v) entitled "Machine Safeguarding"

FIG. 6: MINIMUM SAFETY DISTANCE (US AND CANADA)

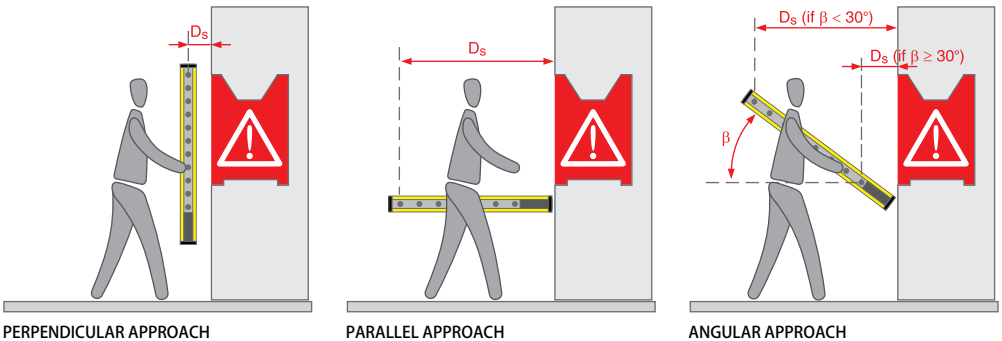

$$D_s = K_s \times (T_s + T_c + T_r + T_{bm}) + D_{pf}$$

where

- D_s : The minimum safety distance in inches or mm from the hazardous zone to the detection point, plan or zone
- K_s : Approach speed of the body or parts of the body in inches/second or mm/second. ANSI standard B11.19-2003, ANSI/RIA R15.06-1999 and OSHA 1910.217(c) specify a recommended value of $K_s = 63$ inches/s (1,600 mm/s).

Components of the overall response time of the machine:

- T_s : Stop time of the machine tool measured at the final control element (seconds)
- T_c : Response time of the control system (seconds)
- T_r : Response time of the presence-sensing device and its interface (seconds)
- T_{bm} : Additional response time allowed for “brake monitor” to compensate for wear. ANSI B11.19-2003 names it T_{spm} standing for “stopping performance monitor” (seconds).

Note: Any additional time delays must also be accounted for in this calculation.

- D_{pf} : Depth penetration factor, an additional distance added to the overall safety distance required. This value is based on the smallest detectable target size which depends on the protective device resolution (inches or mm).

When the AOPD is installed horizontally (parallel to direction of approach) or the angle (β) between the direction of approach and the sensing field is less than 30° , calculate D_s using the ANSI safety distance formula above, with $D_{pf} = 48$ inches. The safety distance is measured from the hazardous point to the sensing beam farthest away.

This calculation guideline summarizes the basic regulations and standards. For details, please refer to the applicable standards.

6. OTHER COUNTRIES

Every country is free to set its own rules and standards in terms of machine safety. Standards applicable in countries outside the European Union and the United States of America are determined by national law-making bodies.

For the correct use, installation and decommission of Safetinx products outside the European Union and the United States of America please consult the relevant national standards and directives.

7. ACRONYMS

ANSI	American National Standards Institute
AOPD	Active Optoelectronic Protective Device
BSI	British Standards Institution
CEN	European Committee for Standardization
CENELEC	European Committee for Electrotechnical Standardization
CLC	CENELEC (in document references)
CSA	Canadian Standards Association
DC _{avg}	Average Diagnostic Coverage
DIN	Deutsches Institut für Normung (German Institute for Standardization)
EN	European Norm
ESPE	Electro-Sensitive Protective Equipment
EU	European Union
FMEA	Failure Mode and Effects Analysis
IEC	International Electrotechnical Commission
IEEE	Institute of Electrical and Electronics Engineers
ISO	International Organization for Standardization
MTTF _d	Mean Time To Dangerous Failure
NFPA	National Fire Protection Association
OEM	Original Equipment Manufacturer
OSHA	Occupational Safety and Health Administration
OSSD	Output Signal Switching Device
PES	Programmable Electronic Systems
PLC	Programmable Logic Controller
TS	Technical Specification
TÜV	Technischer Überwachungsverein
UL	Underwriters Laboratories Inc.



8. TECHNICAL DOCUMENTATION

The Safetinx Extended type 4 product range includes the following products:

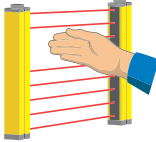

8.1. SAFETINEX YBES FOR HAND PROTECTION

- Safety light curtain with 30 mm resolution
- Protective height from 170 mm to 1,610 mm
- Operating distance up to 5 m
- Pigtail PUR cable, 0.3 m, M12 connector
- Slim housing 26 × 26 mm

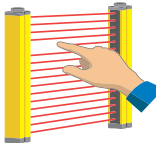

8.2. SAFETINEX YBES FOR FINGER PROTECTION

- Safety light curtain with 14 mm resolution
- Protective height from 170 mm to 1,290 mm
- Operating distance up to 5 m
- Pigtail PUR cable, 0.3 m, M12 connector
- Slim housing 26 × 26 mm

Safetinx light curtains, type 4, Performance Level PLe and Safety Integrity Level SIL 3. Each unit is enclosed in an aluminum profile housing, equipped with two side mounting rails.

The Safetinx product range is complemented by a range of accessories. For details and order information, please consult the section “8.9.1. Available models YBES” (page 41) in this instruction manual, see the General Catalog or go to www.contrinex.com.

8.3. ADVANTAGES OF THE SAFETINEX RANGE

Safetinx safety devices offer the following advantages:

- Very short response time:
 - Finger protection: 9.6 to 34.8 ms
 - Hand protection: 7.8 to 24 ms
- Fully compliant with industry standards and certified by internationally recognized organizations
- Devices certified as type 4, Performance Level PL e and Safety Integrity Level SIL 3
- Beam synchronized, no need for wired connection between sender and receiver
- Short-circuit protected outputs and voltage-reversal protection
- Low power consumption
- Built-in alignment system and easy adjustment of the units thanks to the high flexibility of the Safetinx bracket

- Robust aluminum housing coated with resistant finish
- Compact design: 26×26 mm housing profile
- Competitive price
- No blind zone
- Resolution is maintained even in L-shaped installation or when two units are set next to each other to increase the total light curtain length, twin installation
- Flexible connector
- External device monitoring (EDM)
- Automatic or manual restart selection
- Wireless configuration and programming through Bluetooth®

Furthermore, Safetinex light curtains have been designed to provide users with a comfortable work environment. Their use involves no additional unproductive movements and no waste of time. Users can freely access and move around the machine in complete safety.

8.4. SCOPE OF THIS TECHNICAL DOCUMENTATION

This section contains useful information for the selection, installation, operation and maintenance of Safetinex light curtains. It is intended for skilled personnel with a knowledge of safety issues and electronic equipment. For safety compliance of your installation, please refer to the relevant standards and directives.

8.5. SELF PROTECTED OUTPUTS

Both OSSD1 and OSSD2 are self-protected and actively monitored PNP outputs. Both outputs are controlled by independent current-monitored high-side switches. Thanks to continuous monitoring, any short-circuit between an output and the power supply or ground is detected, leading to the deactivation of the other output. Similarly, a cross-circuit between the two outputs is also detected and both OSSDs are deactivated within the specified response time. The OSSD outputs are switched off and remain in that state as long as the fault remains.

8.6. RESOLUTION (R) OF AN AOPD

The resolution of an AOPD is the minimum diameter that an intruding object must have in order to interrupt, at any angle, at least one of the light beams. The resolution R of an AOPD is dependant on the beam gaps and diameter:

$$R = i + b$$

where i is the interval between the beam axes
and b is the effective infrared beam diameter

Safetinx YBES light curtains type 4 have a resolution of 30 mm or 14 mm. For details and order information, please consult section 8.9.1. "Available models YBES" in this instruction manual, or see the General Catalog, or go to www.contrinex.com.



FIG. 7: RESOLUTION R OF AN AOPD

YBES

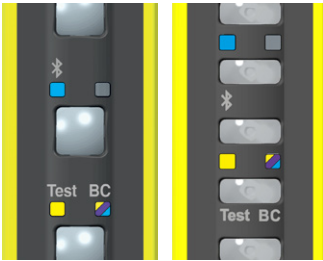

FIG. 8A: LED INDICATORS ON SENDER UNIT (30 MM AND 14 MM RESOLUTION)

8.7. LED STATUS INDICATORS

Sender and receiver units consist of an optical part (lenses) and an LED indicator panel. The LEDs on the sender and receiver units indicate the operating status of the AOPD as shown below:

SENDER

LED	
Bluetooth®	blue when communication through Bluetooth® is enabled blinking blue when data are exchanged (1 Hz)
Beam coding	purple when "Beam Coding #1" option is enabled yellow when "Beam Coding #2" option is enabled blue when "Beam Coding #3" option is enabled
Test	yellow when intrusion simulation is enabled OFF when there is no intrusion simulation

YBES

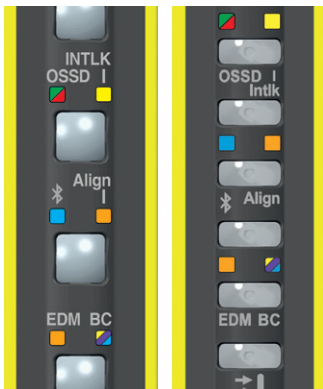

FIG. 8B: LED INDICATORS ON RECEIVER UNIT (30 MM AND 14 MM RESOLUTION)

RECEIVER

LED	
Interlock	yellow when light curtain is waiting for start/restart OFF when restart/start is initiated or when automatic restart is configured
OSSD	green when both OSSD1 and OSSD2 are ON red when both OSSD1 and OSSD2 are OFF
Bluetooth®	blue when communication through Bluetooth® is enabled blinking blue when data are exchanged (1 Hz) OFF when communication through Bluetooth® is disabled
Alignment	steady orange when no beam is aligned blinking orange when fewer than total beam number are aligned (frequency about 1 Hz) OFF when all beams are fully aligned
EDM	orange when EDM is enabled OFF when EDM is disabled
Beam Coding	purple when "Beam Coding #1" option is enabled yellow when "Beam Coding #2" option is enabled blue when "Beam Coding #3" option is enabled

On the YBES series, the sender and the receiver are labeled with a dedicated logo on the front panel to clearly show to the user what is the role of each unit.

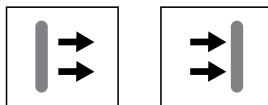

FIG. 8C: SENDER AND RECEIVER LOGOS

8.7.1. TEST MODE SELECTION

The sender unit is equipped with a test mode function controlled through the voltage supply on the test input. Enabling the test mode stops the light beams, simulating an intrusion into the protective field. Note that, as type 4 protective devices, Contrinex Safety light curtains are self-testing. However, the test input may be useful for system setup, to ensure that the machine control circuit operates properly or, to determine the actual response time of the overall safety setup. Table 5 below shows the test functions triggered by the pin connections on the sender unit.

TEST INPUT	FUNCTIONALITY
24 Volts	Test disabled
0 Volts or not connected	Test enabled, intrusion simulated

TABLE 5: TEST MODE SELECTION

For pin assignment information, please consult table 6 on page 46.

8.8. INSTALLATION

Depending on the working environment where the light curtain is to be installed, various factors must be taken into consideration, such as reflective surfaces neighboring the safety device or other safety devices that may potentially cause interference. Other basic safety installation rules include preventing access to the point of hazard through the correct positioning of the protective screen.

Installation of Safetinex protective devices involves the following steps:

- Calculation of the minimum safety distance
- Mounting the sender and receiver units
- Connecting the light curtain
- Aligning the units
- Performing tests before initial commissioning

8.8.1. MINIMUM SAFETY DISTANCE

The distance between the protective field and the hazardous area must be calculated with great care and in compliance with strict regulations. Since these regulations differ slightly, depending on the country where the safety system is operated, please refer to the relevant preceding chapters and the applicable standards for details.

8.8.2. POSITIONING THE SENDER AND RECEIVER UNITS

Safety light curtains can be installed vertically to be used as a shield in front of, or around a hazardous zone. In cases where a larger surface around the hazardous machine needs to be safeguarded, a horizontally mounted AOPD may be appropriate.

Generally speaking, it must not be possible to pass over, around, below or go behind the protective field of the AOPD. If this cannot be guaranteed, then additional protective devices must be used.



FIG. 9: POSITIONING THE LIGHT CURTAIN

If both vertical and horizontal accesses need to be secured, then two protective screens forming an “L” shape, one vertical and one horizontal, are necessary.

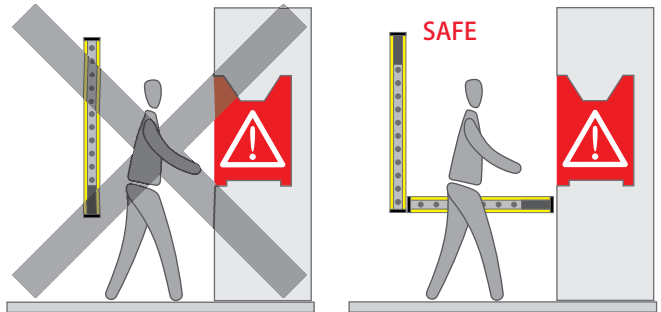

FIG. 10: L-SHAPED INSTALLATION OF THE LIGHT CURTAIN

For practical details on L-shaped installations, please consult the relevant paragraph on page 35 as well as page 39.

8.8.3. DISTANCE FROM REFLECTIVE SURFACES

Reflective surfaces (such as mirrors, glass panes, polished metal parts, etc.) located near the light beams may cause undesired reflections of safety relevant light beams. This can result in a failure to detect opaque objects in the protection field. To avoid such problems, a minimum distance must be maintained between the protective field and any reflective surface, whether above, below or to the side.

The minimum distance (a) between the protective field and a reflective surface depends on the operating distance (d) between the sender and receiver units. The longer the operating distance, the further away reflective surfaces must be kept from the protective field.

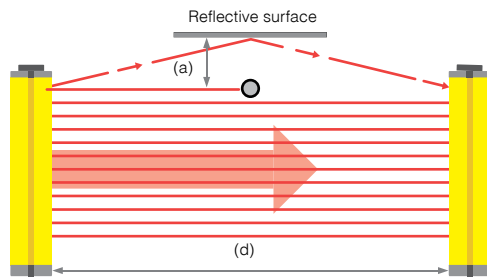

FIG. 11: DISTANCE BETWEEN REFLECTIVE SURFACE AND PROTECTIVE FIELD IS TOO SHORT; A REFLECTED BEAM UNINTENTIONALLY REACHES THE RECEIVER

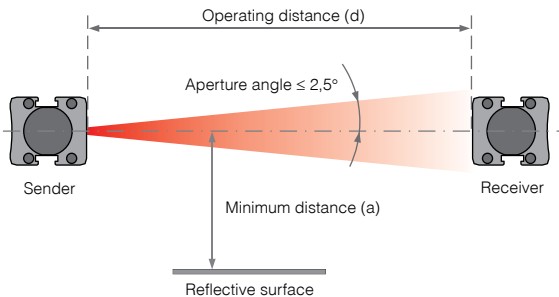

FIG. 12: DISTANCE BETWEEN REFLECTIVE SURFACE AND PROTECTIVE FIELD IS RESPECTED: NO UNDESIRE REFLECTIONS

The following diagram shall be used to determine the appropriate distance.

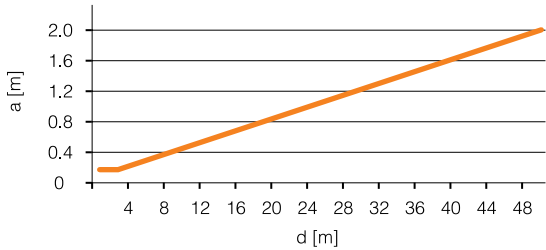

DIAGRAM 4: MINIMUM DISTANCE BETWEEN BEAMS AND REFLECTIVE SURFACE (a) IS DEPENDANT ON OPERATING DISTANCE (d)

Special care must be taken when mounting the YBES with respect to its no-blind-zone capability. Reflections may occur at the base of the light curtain that can be difficult to correct. It is up to the user to check whether or not reflections might influence an installation.

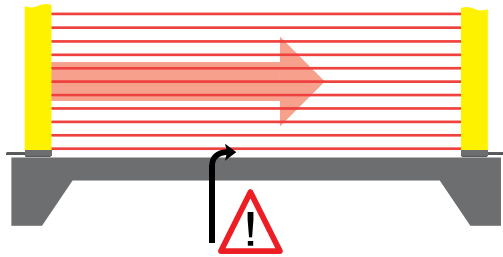

FIG. 13: A SPECIAL CARE MUST BE TAKEN DURING MOUNTING OF YBES SERIES

8.8.4. INSTALLATION OF MULTIPLE SYSTEMS

Each receiver must only and exclusively receive beams from its matching sender. Installing several pairs of AOPDs close to each other may lead to optical crosstalk and result in failing to identify objects within the protective field (Fig. 14).

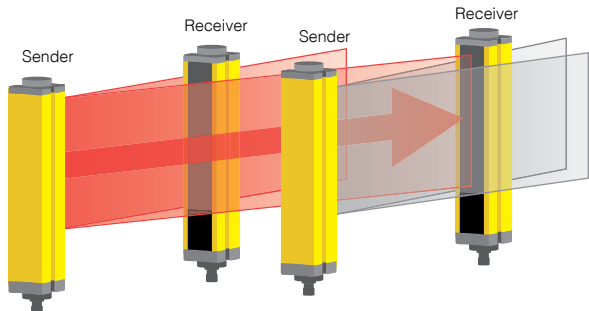

FIG. 14: INTERFERENCE BETWEEN TWO PAIRS OF PROTECTIVE DEVICES

To eliminate the possibility of optical crosstalk, units shall be separated by an opaque shield (Fig. 15).

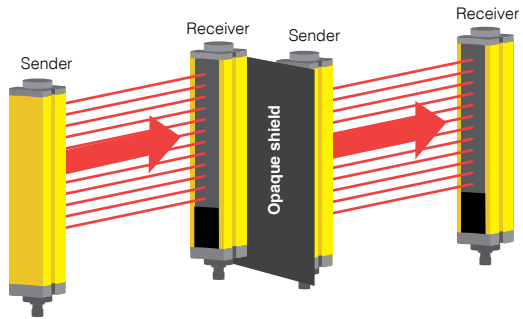

FIG. 15: OPAQUE SHIELD SEPARATION BETWEEN TWO PAIRS OF PROTECTIVE DEVICES



When using an L-shaped installation, the units must be positioned in such a way that the beams run in opposite directions and the top of the units touch each other (Fig. 16).

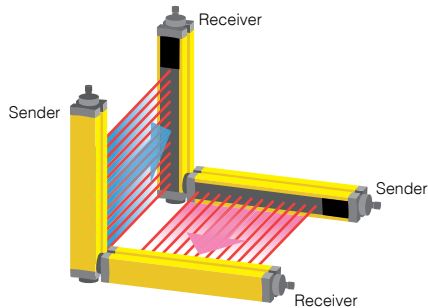

FIG. 16: L-SHAPED INSTALLATION: OPPOSITE DIRECTION

8.8.5. MECHANICAL INSTALLATION

The sender and receiver units must be mounted with their optical panels accurately facing each other. The distance between the two optical faces must be within the specified operating range of the model. The appropriate mounting devices must be used to fix the units. Depending on the application and the available space, different mounting brackets can be used.

8.8.6. MOUNTING WITH BRACKET No. 5 (STANDARD BRACKET)

Mounting bracket no. 5 from Contrinex enables the user to mount the Safetinx YBES type 4 light curtain by fixing it at both ends. It is made of a robust plastic material and comprises two parts. One has an L-shape and is used for fixing the assembly to the application with an M5 screw. The second part is smaller and comprises two pins that slide into the side groove of the light curtain.

When combined, the two parts of the bracket allow orientation of the light curtain in three different directions, each separated by 90°. For each position, a fine adjustment of ± 3 degrees is still possible to perform the final alignment.

Once the position is properly set, the user tightens the M3 screw to clamp the bracket.

Note that a set of these brackets is provided as standard in each package together with the light curtain. Part reference YXW-0005-000 comprises a set of brackets for one unit, not for a pair of light curtains.

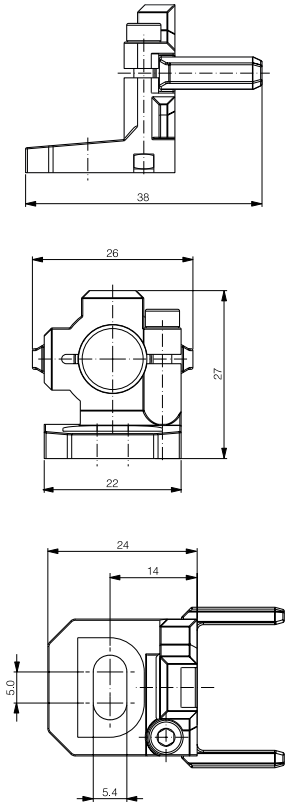

FIG. 17.1: STANDARD TOP/BOTTOM MOUNTING BRACKET No. 5 (REF: YXW-0005-000)

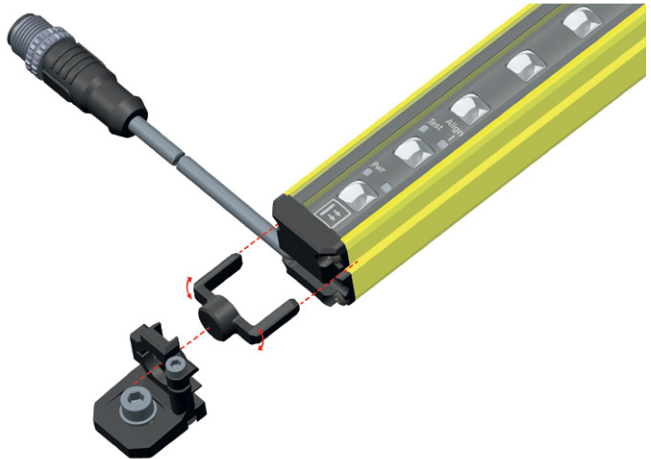
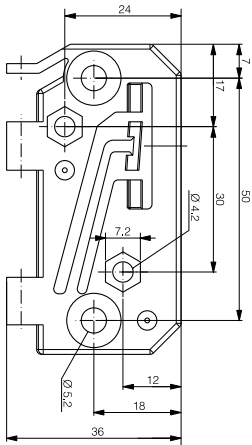

FIG. 17: PART NUMBER: YXW-0005-000



8.8.7. MOUNTING WITH BRACKET No. 6 (OPTIONAL BRACKET)

Mounting bracket no. 6 from Contrinex must be used whenever the no-blind-zone capability of the light curtain is required or when the light curtain must be positioned at a particular angle with respect to the machine. It is made of metal and is also the strongest fixture proposed.

It comprises two identical parts that can either be combined to provide a very flexible system or used as a unique fixture to attach the light curtain in a basic manner to the application.

The light curtain is clamped onto each bracket with a small M4 screw and the bracket is then mounted onto the application with an M5 screw. If two units are combined to achieve more flexibility, the fixture between both brackets is set with an M3 screw.

Part reference YXW-0006-000 comprises two units in the package together with all the necessary screws, including the M5 mounting screws. The two units can either be used as two separate brackets or as one assembly.

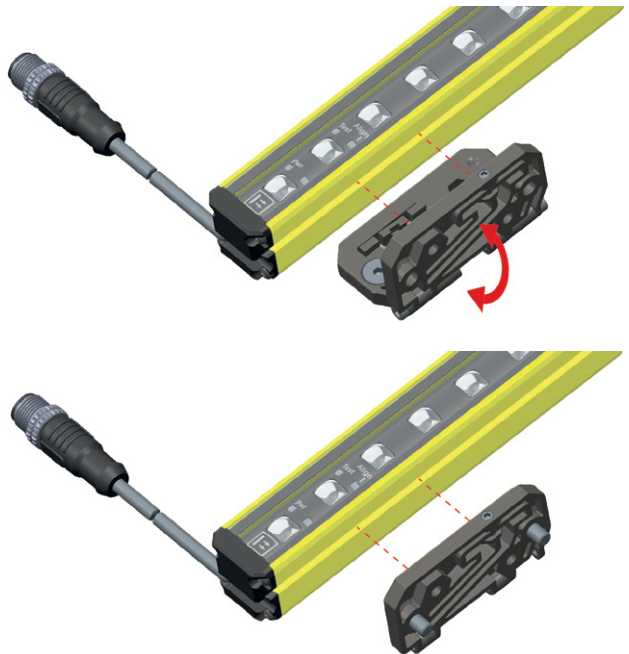
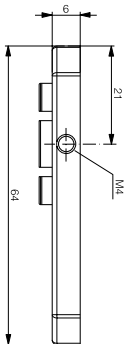
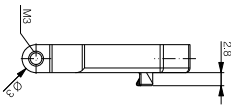

FIG. 18.1: OPTIONAL SIDE-MOUNTING BRACKET No. 6 (REF: YXW-0006-000)

FIG. 18: PART NUMBER: YXW-0006-000

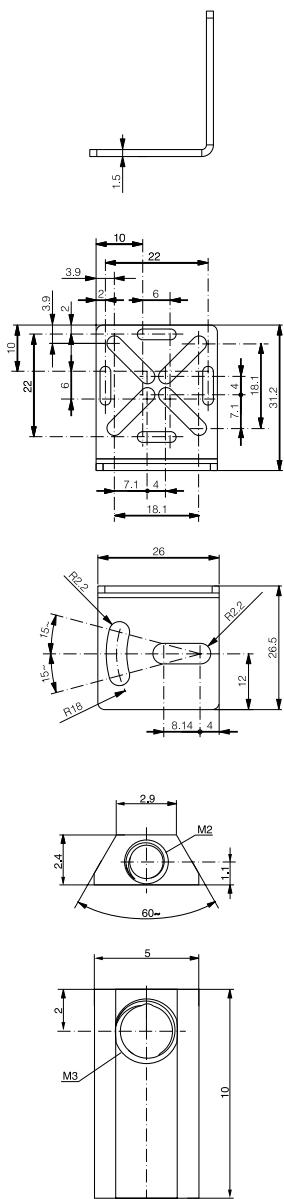

FIG. 19.1: TOP AND BOTTOM OPTIONAL MOUNTING BRACKET No. 7 (REF: YXW-0007-000)

8.8.8. MOUNTING WITH BRACKET No. 7 (OPTIONAL BRACKET)

This bracket is very simple and flexible. It is made of metal and combines the advantages of both brackets no. 5 and no. 6. It keeps the no-blind-zone capability of the light curtain and can be fixed on the side or on the end of the light curtain. It is made of three units, one L-shaped thin metal plate and two metallic nuts that can be inserted in the grooves of the light curtain.

The base plate is fixed to the application with an M4 screw while the nuts either use M2 or M3 screws.

Part reference YXW-0007-000 comprises a set of brackets for one unit, not for a pair of light curtains.

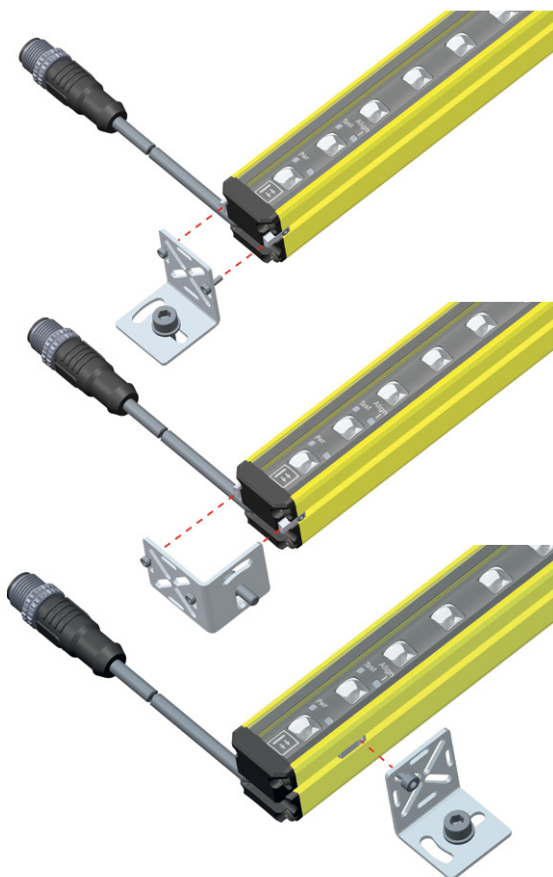

FIG. 19: PART NUMBER: YXW-0007-000



8.8.9. L-SHAPED INSTALLATION

When two units are installed next to each other at an angle of 90°, the issue is often the gap in the protective field at the corner.

Thanks to the YBES type 4 of Contrinex, this is no longer an issue, because the resolution at the corner is maintained.

Remember to invert the position of the sender and receiver units as explained in chapter 8.8.4.

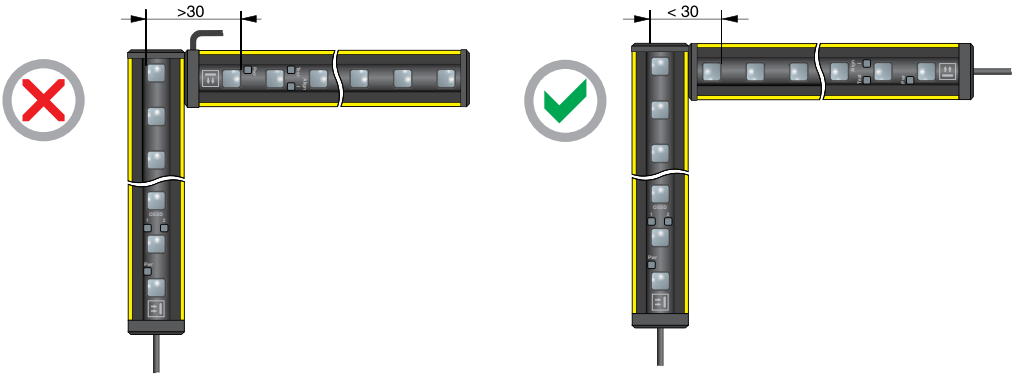

8.8.10. TWIN INSTALLATION AND RESOLUTION AT THE END OF THE LIGHT CURTAIN

The YBES slim profile has the following dimensions at the end of the light curtain:

RESOLUTION 30 MM

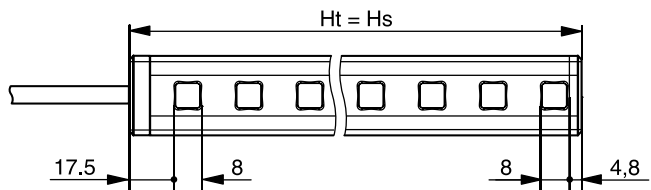

RESOLUTION 14 MM

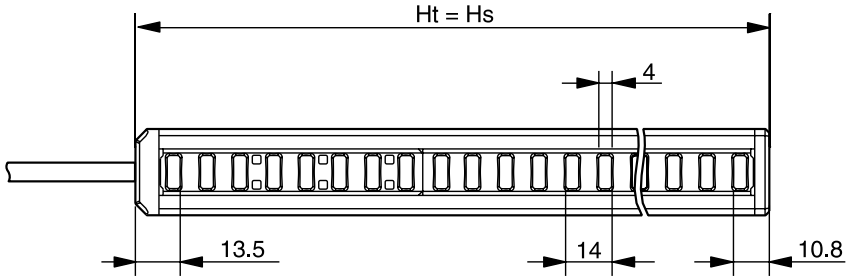

This enables two light curtains to be set next to each other to extend the protective height while keeping the resolution constant:

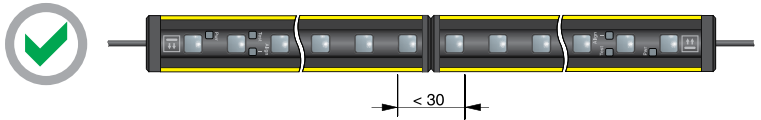

Note that this feature is available only on one side of the light curtain. Moreover, the resolution must be 30 mm.

This feature is not possible with a 14 mm resolution.

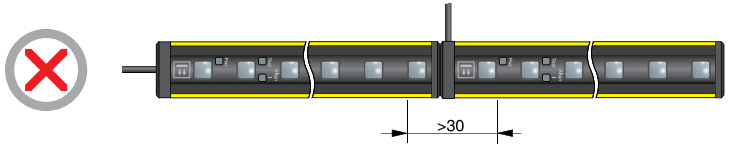

8.8.11. NO BLIND ZONE CAPABILITY

The YBES slim profile has no blind zone in its protective field, thus offering a light curtain with complete protection.

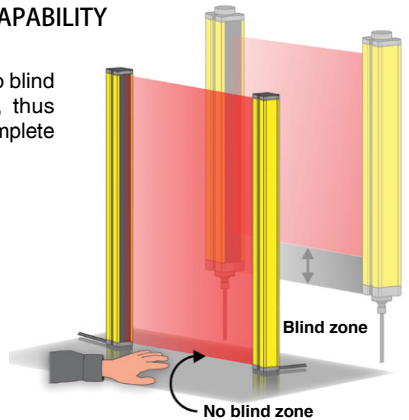

8.9. TECHNICAL SPECIFICATIONS

8.9.1. AVAILABLE MODELS YBES

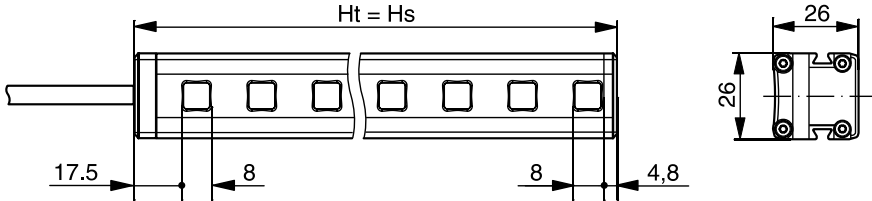

BEAM RESOLUTION: 30 MM

Part reference	Protective Height Hs [mm]	Total Height Ht [mm]	Number of Beams	Current Consumption [mA max.]*	Response Time [ms]	MTTF _d [years]	DC _{avg}	PFH	Dissipated power [W max.]*	Weight [g]
YBES-30x4-0170-P012	170	170	8	30 (S), 35 (R)	7.8	3,049	96.80%	2.523×10^{-8}	1.76	150
YBES-30x4-0330-P012	330	330	16	30 (S), 35 (R)	9.6	2,780	96.99%	2.527×10^{-8}	1.76	260
YBES-30x4-0490-P012	490	490	24	30 (S), 35 (R)	11.4	2,555	97.16%	2.531×10^{-8}	1.76	370
YBES-30x4-0650-P012	650	650	32	30 (S), 35 (R)	13.2	2,364	97.29%	2.534×10^{-8}	1.76	490
YBES-30x4-0810-P012	810	810	40	30 (S), 35 (R)	15	2,199	97.41%	2.538×10^{-8}	1.76	600
YBES-30x4-0970-P012	970	970	48	30 (S), 35 (R)	16.8	2,055	97.52%	2.542×10^{-8}	1.76	710
YBES-30x4-1130-P012	1,130	1,130	56	30 (S), 35 (R)	18.6	1,930	97.61%	2.545×10^{-8}	1.76	820
YBES-30x4-1290-P012	1,290	1,290	64	30 (S), 35 (R)	20.4	1,818	97.69%	2.549×10^{-8}	1.76	930
YBES-30x4-1450-P012	1,450	1,450	72	30 (S), 35 (R)	22.2	1,719	97.76%	2.552×10^{-8}	1.76	1,040
YBES-30x4-1610-P012	1,610	1,610	80	30 (S), 35 (R)	24	1,630	97.82%	2.556×10^{-8}	1.76	1,150

x = S for sender / R for receiver / K for kit (sender + receiver)

*Excl. load

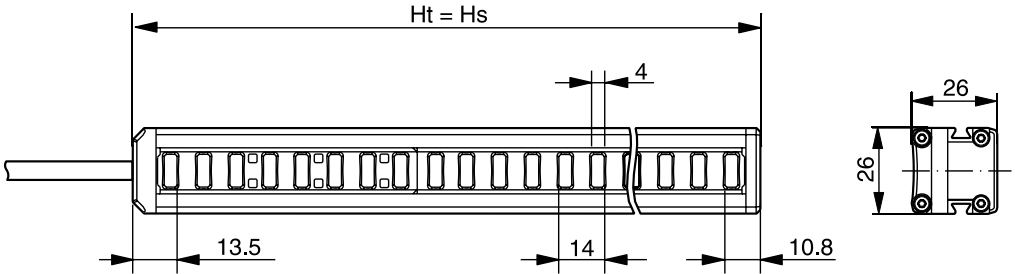

BEAM RESOLUTION: 14 MM

Part reference	Protective Height H_s [mm]	Total Height H_t [mm]	Number of Beams	Current Consumption [mA max.]*	Response Time [ms]	MTTF _d [years]	DC _{avg}	PFH	Dissipated power [W max.]*	Weight [g]
YBES-14x4-0170-P012	170	170	16	30 (S), 35 (R)	9.6	2,780	96.99%	2.527×10^{-8}	1.76	150
YBES-14x4-0330-P012	330	330	32	30 (S), 35 (R)	13.2	2,364	97.29%	2.534×10^{-8}	1.76	260
YBES-14x4-0490-P012	490	490	48	30 (S), 35 (R)	16.8	2,055	97.52%	2.541×10^{-8}	1.76	370
YBES-14x4-0650-P012	650	650	64	30 (S), 35 (R)	20.4	1,818	97.69%	2.549×10^{-8}	1.76	490
YBES-14x4-0810-P012	810	810	80	30 (S), 35 (R)	24	1,630	97.82%	2.556×10^{-8}	1.76	600
YBES-14x4-0970-P012	970	970	96	30 (S), 35 (R)	27.6	1,477	97.93%	2.563×10^{-8}	1.76	710
YBES-14x4-1130-P012	1,130	1,130	112	30 (S), 35 (R)	31.2	1,351	98.02%	2.570×10^{-8}	1.76	820
YBES-14x4-1290-P012	1,290	1,290	128	30 (S), 35 (R)	34.8	1,244	98.10%	2.578×10^{-8}	1.76	930

x = S for sender / R for receiver / K for kit (sender + receiver)

*Excl. load

8.9.2. TECHNICAL DATA YBES

BEAM RESOLUTION: 30 MM	
Housing size	26 × 26 mm × Height
Supply voltage	24 VDC ± 20%
Current consumption sender (TX)	30 mA
Current consumption receiver (RX) (excl. load)	35 mA
Polarity	2 PNP outputs short-circuit protected
Output current	Max. 0.4 A per output
Output voltage ON min.	−2 V @400 mA of the operating voltage
Output voltage OFF max.	1.0 V
Leakage current when OFF state	< 2 mA
Maximum load inductance	100 mH
Response time	See "Available models" table above
Sender wavelength	IR 850 nm
Resolution	30 mm
Operating range	0.25 ... 5 m
Safety level	Cat. 4, PLe (EN/ISO 13849-1) Type 4 (IEC 61496-1/-2) SIL 3 (IEC 61508-1/-2/-3) SILCL3 (IEC 62061:A2)
Ambient temperature range	0 ... +55°C (+32 ... +131°F)
Storage temperature range	−25 ... +70°C (−13 ... +158°F)
Air humidity	15 ... 95% (non-condensing)
Electrical protection class	III (IEC 61140)
Enclosure rating (EN 60529) (depending on model)	IP65
Light immunity	IEC 61496-2
Reference standards	IEC 61496-1/-2, IEC 61508-1/-2/-3, IEC 62061:A2, ISO 13849-1
Housing material	Aluminum (Al MgSiMn)
Material of upper and lower cover	PA + 30% fiberglass
Material of optics	PC
Bluetooth® range	< 20 m
Configuration	Low energy (LE), V5.0 (compatible 4.1 or later)
Tm (mission time)	20 years
Type	B (IEC 61508-2)

BEAM RESOLUTION: 14 MM

Housing size	26 × 26 mm × Height
Supply voltage	24 VDC ± 20%
Current consumption sender (TX)	30 mA
Current consumption receiver (RX) (excl. load)	35 mA
Polarity	2 PNP outputs short-circuit protected
Output current	Max. 0.4 A per output
Output voltage ON min.	−2 V @400 mA of the operating voltage
Output voltage OFF max.	1.0 V
Leakage current when OFF state	< 2 mA
Maximum load inductance	100 mH
Response time	See “Available models” table above
Sender wavelength	IR 850 nm
Resolution	14 mm
Operating range	0.4 ... 5 m
Safety level	Cat. 4, PLe (EN/ISO 13849-1) Type 4 (IEC 61496-1/-2) SIL 3 (IEC 61508-1/-2/-3) SILCL3 (IEC 62061:A2)
Ambient temperature range	0 ... +55°C (+32 ... +131°F)
Storage temperature range	−25 ... +70°C (−13 ... +158°F)
Air humidity	15 ... 95% (non-condensing)
Electrical protection class	III (IEC 61140)
Enclosure rating (EN 60529) (depending on model)	IP65
Light immunity	IEC 61496-2
Reference standards	IEC 61496-1/-2, IEC 61508-1/-2/-3, IEC 62061:A2, ISO 13849-1
Housing material	Aluminum (Al MgSiMn)
Material of upper and lower cover	PA + 30% fiberglass
Material of optics	PC
Bluetooth® range	< 20 m
Configuration	Low energy (LE), V5.0 (compatible 4.1 or later)
Tm (mission time)	20 years
Type	B (IEC 61508-2)



8.10. CONNECTING THE PROTECTIVE DEVICE

Please note that all electrical connections must be performed by experienced and qualified personnel.

8.10.1. POWER SUPPLY

The power supply to both the sender and receiver units must be 24 VDC \pm 20%. The power consumption depends on the model. Please refer to the data sheets for details.

The external supply voltage must be capable of buffering brief main voltage failures of 10 ms as specified in IEC 61496-1.

Use a dedicated 24 VDC, Class 2 Safety Extra-low Voltage (SELV) or Protective Extra-low Voltage (PELV) power supply to supply each unit. These power supplies provide the necessary protection to ensure that under normal and single-fault conditions, the voltage between the different conductors, and between conductors and functional earth, does not exceed a safe value.

8.10.2. ELECTROMAGNETIC COMPATIBILITY (EMC)

In terms of immunity to electromagnetic fields, Safetinex protective devices fully comply with EN 55011/A2 and EN 61000-6-4 (electrostatic discharge, electrical and radio-frequency disturbances). Proximity to potential electromagnetic interference is acceptable within the limits of these standards.

In case of presence of strong electromagnetic fields, the use of shielded 5-pin or 8-pin cables is strongly recommended.

8.10.3. LIGHT RADIATION

Additional measures may be necessary to ensure that the AOPD does not fail to danger when other forms of light radiation are present in a particular application (for example, use of cableless control devices on cranes, radiation from weld spatter or effects from stroboscopic light).

8.10.4. PIN ASSIGNMENT FOR YBES SERIES

M12 PIGTAIL, 0.3 M PUR CABLE

Fig. 20, 21 and table 6 show how to connect the M12 pins.

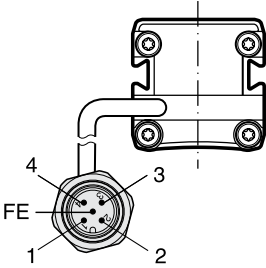

FIG. 20: M12 PIN ASSIGNMENT (SENDER)

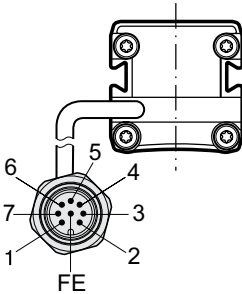

FIG. 21: M12 PIN ASSIGNMENT (RECEIVER)

ASSIGNMENT	FUNCTION	PINS/WIRES ON SENDER		PINS/WIRES ON RECEIVER	
		M12	OPEN CABLE	M12	OPEN CABLE
Power supply	24 VDC	1	brown	2	brown
Power supply	0 V	3	blue	7	blue
Test mode	24 V: test inactive 0 V: test active	4	black	–	–
Output	OSSD1	–	–	5	gray
Output	OSSD2	–	–	6	pink
Functional earth	Shield	FE	gray	FE	red
EDM	EDM input	–	–	4	yellow
Restart Interlock	Input for restart button	–	–	1	white
Not used	–	2	white	3	green

TABLE 6: M12 PIN ASSIGNMENT YBES

Important note applicable to all Safetinx models:



The same power supply must be used for the safety relay and both AOPD units. If this is not possible and these devices are connected to galvanically separated power supplies, then the 0 V contact of the AOPD units and the A2(–) contact of the safety relay must be bridged.

8.11. SAFETINEX SAFETY RELAY YRB-4EML-31S

As a part of the Safetinex product line, the safety relay YRB-4EML-31S can be used to connect YBES protective devices to the machine control system. The relay complies with the requirements of Category 4/ Performance Level e according to EN/ISO 13849-1. It can be used in applications up to Category 4/Performance Level e according to EN/ISO 13849-1 and SIL 3 according to EN 62061. Its LED indicate the power supply.



FIG. 22: SAFETY RELAY YRB-4EML-31S

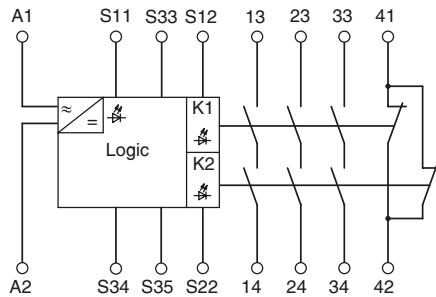

FIG. 23: BLOCK DIAGRAM

8.11.1. RESPONSE TIME FROM PROTECTIVE FIELD INTRUSION TO SWITCHING OF SAFETY RELAY

For proper calculation of the minimum safety distance, it is essential to understand that every element in the machine safety chain contributes to a delay in the so-called “overall” or “total response time” of the safety system.

To visualize this, please note that figure 24 (following page) indicates the reaction time of an AOPD wired to the YRB-4EML-31S safety relay. Additional machine control elements as well as the machine’s own stopping time will increase the “overall” or “total response time” of the safety system as described in the chapters 5.1.3. “Minimum safety distance calculation (EU)” and 5.1.4. “Minimum safety distance calculation (US and Canada)” above.

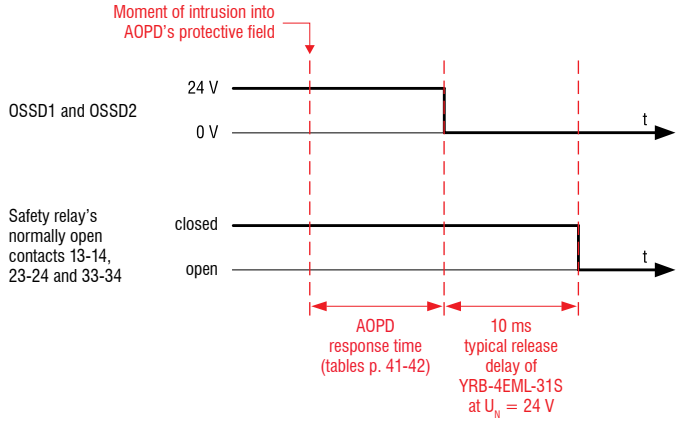
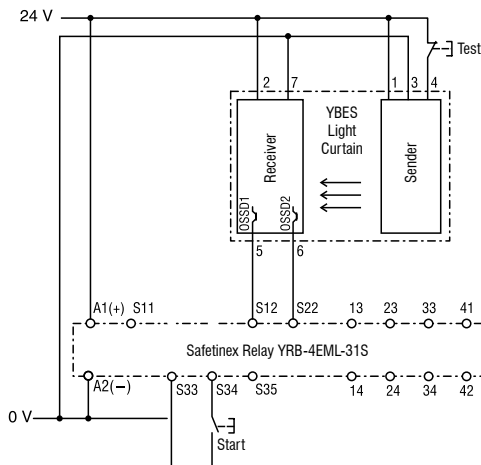

FIG. 24: SEQUENCE OF RELAY SWITCHING OPERATION

8.11.2. CONNECTION EXAMPLES FOR YRB-4EML-31S SAFETY RELAY

Below are two typical examples for connecting a Safetinx AOPD, using channel 1, to a Safetinx YRB-4EML-31S relay:

1 - For **Manual Restart** mode:



Light curtain pin numbers refer to M12 connector.

FIG. 25: CONNECTION DIAGRAM FOR MANUAL RESTART MODE



Important notice: the restart button must always be located outside the hazardous area!

2 - For **Automatic Restart** mode:

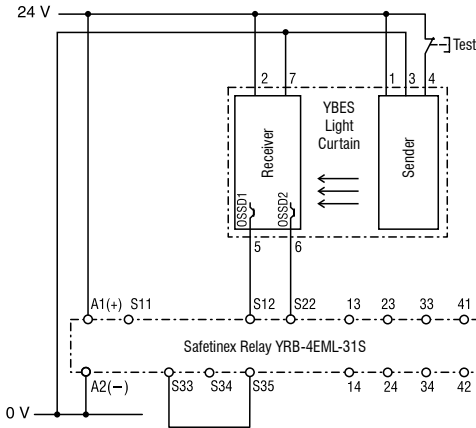

Light curtain pin numbers refer to M12 connector.

FIG. 26: CONNECTION DIAGRAM FOR AUTOMATIC RESTART MODE

8.12. CONNECTION CABLES

Various cables are offered to connect on the M12, 5-pole or M12, 8-pole connector of the light curtain.

It is recommended to use a PUR cable for a better lifetime. The maximum length of cable that is recommended is 25 m. In theory, cables up to 100 m can be used. Cables with 4 pins can also be used.

In case of presence of strong electromagnetic fields, the use of shielded 5-pin or 8-pin cables is strongly recommended.



M12 straight socket



M12 right angle socket

ARTICLE NUMBER	MATERIAL	LENGTH (m)	NUMBER OF POLES	SOCKET TYPE	SHIELDED
S12-5FUG-020-NWSN	PUR	2	5	straight	✓
S12-5FUG-050-NWSN	PUR	5	5	straight	✓
S12-5FUG-100-NWSN	PUR	10	5	straight	✓
S12-5FUG-150-NWSN	PUR	15	5	straight	✓
S12-5FUG-250-NWSN	PUR	25	5	straight	✓
S12-5FVG-020	PVC	2	5	straight	
S12-5FVG-050	PVC	5	5	straight	
S12-5FVG-100	PVC	10	5	straight	
S12-5FVG-150	PVC	15	5	straight	
S12-5FVG-250	PVC	25	5	straight	
S12-5FVW-020	PVC	2	5	right angle	
S12-5FVW-050	PVC	5	5	right angle	
S12-5FVW-100	PVC	10	5	right angle	
S12-5FUG-020	PUR	2	5	straight	
S12-5FUG-050	PUR	5	5	straight	
S12-5FUG-100	PUR	10	5	straight	
S12-5FUG-150	PUR	15	5	straight	
S12-5FUG-250	PUR	25	5	straight	
S12-8FUG-020	PUR	2	8	straight	
S12-8FUG-050	PUR	5	8	straight	
S12-8FUG-100	PUR	10	8	straight	
S12-8FUG-020-NWSN	PUR	2	8	straight	✓
S12-8FUG-050-NWSN	PUR	5	8	straight	✓
S12-8FUG-100-NWSN	PUR	10	8	straight	✓
S12-8FUG-150-NWSN	PUR	15	8	straight	✓

8.13. ALIGNMENT OF SENDER AND RECEIVER UNITS



To complete the installation of the AOPD and to ensure proper functioning of the protective device, the sender and the receiver must be accurately aligned. Perfect alignment is achieved when each emitted light beam reaches its corresponding optical element on the receiver unit. This means positioning the two units so that the maximum amount of emitted light



energy reaches the receiver element. The specified maximum optical aperture angle ($\pm 2.5^\circ$) requires accuracy in aligning the two units before they are firmly fixed in place.

During the alignment process, the OSSD output signals of the protective device must not have any effect on the machine. Make sure the machine remains switched off. Also the start/restart function must be deactivated during the alignment.

The alignment process is facilitated by the dedicated orange LED indicator on the sender unit. The illustrations below show how the LED behaves during the alignment process.

Alignment is achieved in four steps. During this process, please ensure that the green "Power" LED on the receiver remains on:

1. Fix the receiver unit in its final position and place the sender in such a way that the orange LED of the receiver (alignment) blinks rapidly. This indicates alignment of, at minimum, the bottom beam and, at maximum, 6 beams (those nearest to the display).

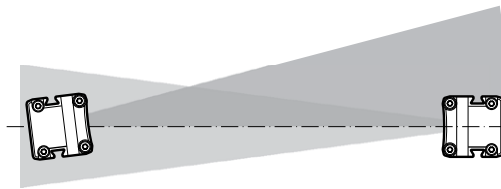

2. Rotate or slightly tilt in one direction the mobile unit until the orange LED stays ON. This means that the light curtains are not aligned and the maximum point in one direction is found.

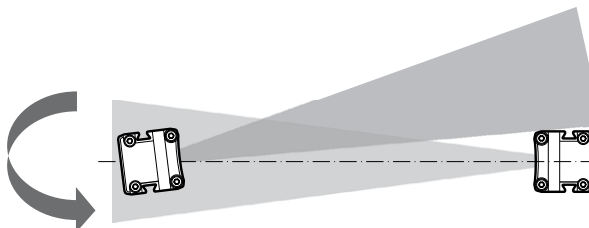

3. Rotate or slightly tilt in the other direction the mobile unit until the orange LED stays ON. This means that the light curtains are not aligned and the maximum point in the other direction is found.

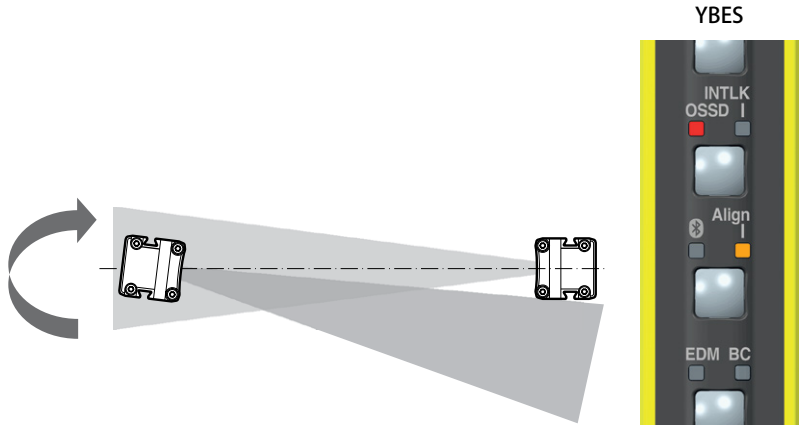

4. Adjust the position of the loose unit in the middle of those extreme positions noted at point 2 and 3. The orange alignment LED goes off and the OSSD1 and OSSD2 LEDs turn green on the receiver. The barrier is now properly aligned. Tighten the mounting screws on both units.

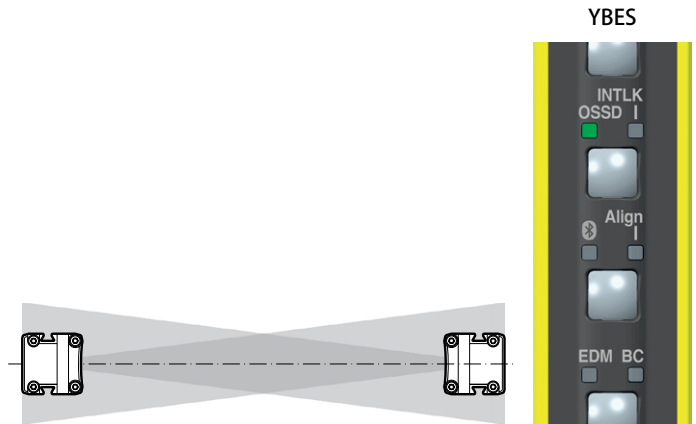

The quality of alignment is also monitored by the ContriApp application for smartphones and other portable devices. Please refer to the software manual for further information.

8.14. TEST BEFORE THE FIRST COMMISSIONING

Before connecting OSSD1 and OSSD2 to the machine control, perform the “Daily functional test” as described in chapter “Testing and maintenance” below. This final test ensures that the protective device is operating properly.



9. TESTING AND MAINTENANCE

9.1. DAILY FUNCTIONAL TEST

As operating conditions in the working environment may change from day to day, it is very important to perform the functional test daily, at change of shifts, and at each change of the machine operating mode. This will ensure the effectiveness of the protective device.

The test must be performed with the supplied test rod. In case of multiple light curtains in the installation, make sure that the diameter of the test rod matches the resolution indicated on the light curtain units.



Do not use your fingers, hand or arm to check the protective field. Only use the appropriate rod.

Perform the test at three different locations within the protective field, from top to bottom, or from bottom to top:

- Close to the receiver unit
- Close to the sender unit
- In the middle between the receiver and the sender units

Hold the stick in the direction of the hazardous area perpendicular to the detection zone. While moving it slowly* within the field, ensure that the receiver’s OSSD1 and OSSD2 LEDs remain on continuously in red. If at any time an LED OSSD1 and/or OSSD2 turns green, the test has ended in failure and the machine cannot be used until the problem has been resolved appropriately.

Use a daily testing log file as printed on page 59 of this manual to make sure the test is carried out on a daily basis.

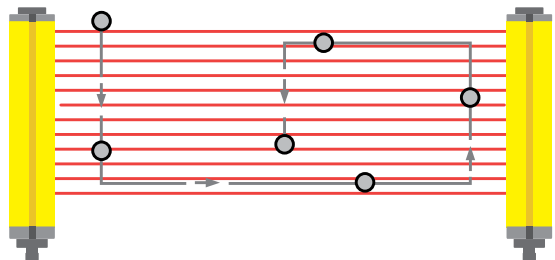

FIG. 27: DAILY ROD TEST

*Please note that, according to IEC 61496-2, the maximum rod speed must not exceed 1.6 m/s.

10. SPECIAL FUNCTIONALITIES

The parameters of the light curtain can be configured through a smart-phone application named ContriApp that can be found on Apple and Google stores. Please refer to the software manual for more information and instructions.

10.1. EXTERNAL DEVICE MONITORING (EDM)

EDM allows the user to connect the light curtain to a non-safe relay or controller if a feedback signal from the contacts can be sent to the light curtain. It means that the monitoring of the contacts is done in the light curtain. This can provide a significant reduction of complexity in the connection plan and also contributes to the reduction of the installation costs.

The factory default setting is “deactivated”, which means that the light curtain is not ready for EDM. This functionality must be turned on with the ContriApp application (please refer to the software manual for more information).

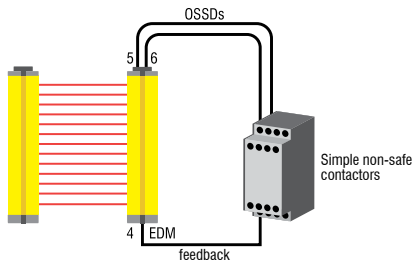

FIG. 28: CONNECTION WITH EDM ACTIVATED

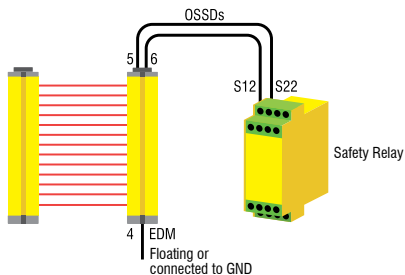

FIG. 29: CONNECTION WITH EDM DEACTIVATED

Note: The EDM input signal is antivalent to OSSD status:

The timing diagram explains the relationship between the cause (OSSDs) and the effect (EDM) with the maximum permissible delay:

- $T_c < 350$ ms: Time between OFF-ON transition of the OSSDs and EDM test
- $T_o < 100$ ms: Time between ON-OFF transition of the OSSDs and EDM test

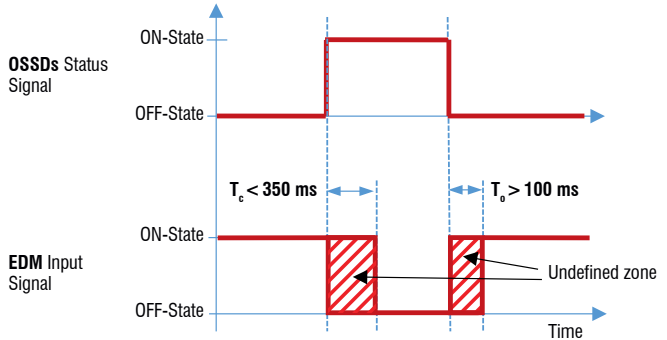

FIG. 30: EDM INPUT SIGNAL TIMING DIAGRAM

10.2. AUTOMATIC OR MANUAL RESTART (RESTART INTERLOCK)

Once the OSSDs of the light curtain have turned off due to a safety alert, they may turn on again if the danger disappears. To prevent the machine contacts from closing again automatically, a manual restart can be set instead of an automatic one.

This functionality is set through the application ContriApp (please refer to the software manual) and is by default set to automatic. When “manual” is selected, a start button has to be connected to the light curtain directly.

Together with the EDM functionality, automatic and manual restart allows the user to connect the light curtain directly to the contact of the machine while keeping a category 4 safety level. This brings the costs of installation down and reduces the complexity of the connection.

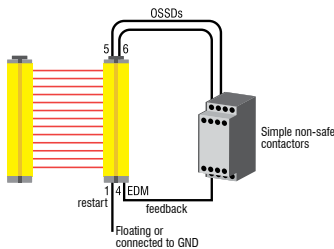

FIG. 31: CONNECTION OF LIGHT CURTAIN WITH EDM TURNED ON AND AUTOMATIC RESTART SELECTED

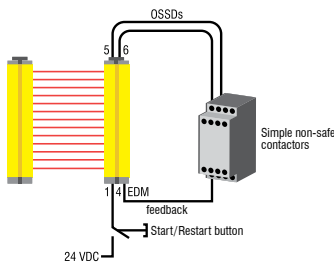

FIG. 32: CONNECTION OF LIGHT CURTAIN WITH EDM TURNED ON AND MANUAL RESTART SELECTED

10.3. BEAM CODING

In order to avoid cross-talk between various pairs of light curtains, each beam is coded and up to three different codes can be generated. This allows the user to have up to three pairs of light curtains working next to each other without mutual interference.

The selection of the code is done through the ContriApp application (please refer to the software manual).

Both the sender and the receiver of a pair must be assigned the same code. The status of each is visible thanks to a colored LED on the front face of each unit.

10.4. DIAGNOSTICS

With the ContriApp application, it is possible to access various data from the light curtain. The data of the last software update, the status of the device or the quality of the alignment between the sender and the receiver can all be monitored.

Further details are given in the software user manual.

10.5. PREPARATION OF THE CONFIGURATION

As delivered, the YBES light curtain is configured ready for protective operation. The table below indicates all the functions that can be configured.

FUNCTION	YBES SENDER	YBES RECEIVER
Beam coding	✓	✓
External device monitoring (EDM)		✓
Start		✓
Restart Interlock		✓
Sender Test	✓	

Prior to any configuration, make sure the light curtain is properly installed and ready for use. Then have a tablet or smartphone with Bluetooth® 4.1 ready, on which ContriApp has been installed.

The configuration of all safety parameters, functions and diagnostic information is then performed through the application. Please refer to the software manual for more information on the use of the application.



10.6. TROUBLESHOOTING

In case of a malfunction, first make sure the machine is completely stopped and all potential dangers have been eliminated before proceeding any further.

The following chart will help quick troubleshooting in the case of a malfunction.

LED DISPLAY	POTENTIAL CAUSE	MEASURES TO CLEAR ERROR
Yellow "test" LED (on sender) is lit	Protective device is in Test Mode	Connect test input to 24 V in order to disable test mode (see table 6, p. 46)
Orange alignment LED (Sender) is on or blinking	Protective device alignment is poor	Follow instructions describing how to align the protective device (see chapter 8.13., p. 50)
Power LED (receiver) does not light up	No operating voltage or voltage is too low	Check the voltage supply
LED OSSD remain on in red	Protective field is obstructed	Remove any object in the protective field
	or alignment is poor	Realign the sender and receiver units (see chapter 8.13., p. 50)
	or fault detected	Switch the power supply off and on again on both units
LED OSSD remain on in red The sender's LEDs are off, excluding the Power LED	or OSSD short-circuit	Ensure that OSSDs are neither shorted together, nor connected to 0 V or 24 VDC
	or device malfunction	Return unit for revision
LED BT ON or blinking and LED OSSD red (receiver) LED BT ON or blinking (sender)	Restart/start function is active	Deactivate the start/restart function
	An object is obstructing the field	Remove object from field

TABLE 7: TROUBLESHOOTING

10.7. PREVENTIVE PERIODIC INSPECTIONS

The EU directive on the use of machinery equipment stipulates the regular inspection of safety devices. Light curtains and access control barriers must be periodically tested by qualified and trained personnel. This allows early detection of new hazards and helps maintain the necessary level of safety. At the same time, it should be checked that the protective devices operate in accordance with the current use of the machine. Periodic inspections give the opportunity to ensure that the type of protective device corresponds to the hazards actually encountered, that the user cannot bypass it and that nothing hinders its functionality.

Please use a form such as the one on table 8 (p. 59) of this manual. It will help keep track of periodic testing.

10.8. CLEANING

In order to keep the protective device in full operating condition and prevent potentially biased results, the active screens on the sender and receiver units must be regularly cleaned. The cleaning frequency depends on the ambient air pollution and the presence of dust and dirt on the screen. Use a mild and non-abrasive detergent to remove dirt from these surfaces, then dry the screen with a soft cloth. After cleaning, the daily functional test, as described above, must be performed in order to detect potential position changes of the protective devices.

10.9. DAILY TESTING LOG FILE

The following tests must be carried out every day the protective device is in operation.

The tests must be conducted by authorized and trained personnel, and entered in a log file as printed on table 8 of this manual.

- Check for signs of external damage, particularly to the front screen, the mounting or the electrical connections.
- Check that it is not possible to access the machine's danger zone from any unprotected area.
- Test the protective field: Perform the daily functional test as described above.

If any of the above tests have failed, block the machine immediately to prevent its use and notify the supervisor.

11. CERTIFICATIONS

YBES series has been certified by the following international laboratories:



TÜV SÜD



Underwriters Laboratories (UL)



CE



Bluetooth® SIG



Federal Communications Commission
(FCC) ID: 2AAQS-ISP1507



SRRC CMIIT ID: 2020DJ10595



Anatel: 08178-20-13106



NOM & NYCE IFT: RCPCOYB20-1165

12. DISCLAIMER

A safety light curtain is a safety device, designed to protect operators and other personnel working around a potentially dangerous machine. Before installing or using a safety light curtain the following requirements must be met:

- This instruction manual is part of the Safetinx light curtain. It must remain accessible during its whole life cycle for anybody in charge of installation, operation, maintenance, cleaning and safety control.
- Safetinx products are only safe protective devices if all the procedures in this instruction manual and in the related documents are carefully followed and fully complied with. If these instructions are not entirely followed, or the safety device is subject to manipulation, it may lead to serious injury or death. Contrinex AG declines any responsibility in case of faulty installation and/or manipulation of Safetinx devices.
- In any installation where the light curtain is used as a safety device, the employer is responsible for ensuring that all applicable governmental requirements are satisfied. The installer is also responsible for complying with all local laws and standards.
- The installation and inspection of the protective device must be performed by trained and qualified specialists, i.e. personnel technically experienced in operating the machinery and the specific protective device involved, and well aware of the applicable safety regulations and standards.
- The employer must ensure that all machine operators, maintenance personnel, supervisors, etc. are familiar with and understand all instructions regarding the proper use of the light curtain, the machinery on which it is installed and the appropriate safety regulations. Operators must be instructed and trained by qualified specialists.
- Optoelectronic protective devices cannot be used as stand-alone solutions if the operator is exposed to any risk of injury from flying or splashing (e.g. molten) materials. Light curtains do not offer protection against flying objects.
- The machine for which the safety light curtain is installed must be able to stop its motion at any point in its cycle.
- Light curtains cannot be used on any machinery that has an irregular stopping time or inadequate control devices or mechanisms.
- Light curtains cannot be used where the environment may weaken the efficiency of the protective device.
- If the light curtain cannot protect all accesses to the hazardous area, additional safeguards, such as mechanical guards, may be required.
- All brakes and other stopping mechanisms and controls must be inspected regularly to ensure they are in proper working order. If the stop mechanisms are not performing properly, the machine may not stop safely even though the light curtain is functioning properly.

- The test procedure described in this instruction manual must be performed during installation and after any maintenance, cleaning, adjustment, repair or modification to the light curtain, or the machine. In addition, the test procedure must be carried out every time the system is started, in general, once a day.
- The log file presented in this manual must be used to document the regular testing of Safetinex products. Contrinex AG declines any responsibility if the test procedure has not been carried out as prescribed in this instruction manual and fully documented in the log file. Testing ensures that the light curtain and the machine control system properly stop the machine.
- The device contains no parts that require maintenance. In case of failure, do not open the device, but send it to manufacturer for repair. Opening the device or implementing unauthorized changes voids any warranty.
- Contrinex AG declines any responsibility if the protective device is not used for its specific purpose, or if it has been modified, whether before, during or after installation.

The enforcement of these requirements is outside Contrinex's control. The employer is responsible for following the above provisions and any other procedures, conditions and requirements specific to the machinery.

13. EC DECLARATION OF CONFORMITY



EG-Konformitätserklärung Déclaration de conformité CE EC-Declaration of Conformity

Nr. / N° / No. 2021_405

Wir
Nous
We

CONTRINEX AG, route du Pâqui 5, CH-1720 Corminboeuf

(Name und Anschrift des Anbieters / Nom et adresse du fournisseur / Supplier's name and address)

erklären in alleiniger Verantwortung, dass die Produkte
déclarons sous notre propre responsabilité, que les produits
declare under our sole responsibility that the products

Lichtschranken-Schaltgerät
Relais de sécurité
Safety relay

YRB-4EML-31S

(Bezeichnung, Typ oder Modell / Nom, type ou modèle / Name, type or model)

mit folgender(en) europäischen Richtlinie(n) übereinstimmen:
est (sont) conforme(s) avec la (les) directive(s) européenne(s) suivante(s):
conform(s) to the following European standard(s):

EMC Directive 2014/30/EU
RoHS Directive no. 2011/65/EU
European Directive on Safety of Machinery 2006/42/EC

Dies wird nachgewiesen durch die Einhaltung folgender Norm(en):
Ceci est démontré par la conformité à (aux) norme(s) suivante(s):
This is documented in accordance with the following standard(s):

EN ISO 13849-1:2015 **EN 62061:2005 + A2:2015**
EN 61000-6-4:2007 + A1:2011* **EN 61000-6-2:2005 + AC:2005**

Notifizierte Stelle / Organisme notifié / Notified body:

TüV Rheinland Industrie Service GmbH
Alboinstrasse 56, DE-12103 Berlin
Certificate No. 01/205/5480.01/18

Corminboeuf, 06.12.2021

*(Ort und Datum der Ausstellung /
Lieu et date de délivrance /
Place and date of issue)*

Genilloud Laurent
2021.12.21 07:29:43 +01'00'

*(Name und Unterschrift oder gleichwertige Kennzeichen
des (der) Befugten / Nom et signature ou identification
équivalente de (des) autorisé(s) / Name and signature or
equivalent identification of authorized person(s))*

*Warnung: Dies ist ein Klasse A-Erzeugnis. In Wohngebieten kann es zu Störungen des Funkempfanges kommen. Der Betreiber soll ent-
sprechende Schutzmassnahmen treffen.

*Warning: This is a Class A product. In a domestic environment it may cause radio interference, in which case the user may be required to
take adequate measures.

Diese Erklärung bescheinigt die Übereinstimmung mit den genannten Richtlinien, beinhaltet jedoch keine Zusicherung von Eigenschaften.
Die Sicherheitshinweise der Produktdokumentation sind zu beachten. Diese Konformitätserklärung entspricht der Europäischen Norm EN ISO/
IEC 17050-1:2004-10 «Konformitätsbewertung – Konformitätserklärung von Anbietern – Teil 1: Allgemeine Anforderungen».

Cette déclaration certifie la conformité des directives mentionnées, mais ne comprend aucune garantie des caractéristiques du produit. Les
directives de sécurité de la documentation du produit sont à considérer. Cette déclaration de conformité est basée sur la norme européenne
EN ISO/CEI 17050-1:2004-10 «Évaluation de la conformité – Déclaration de conformité du fournisseur – Partie 1: Exigences générales».

This declaration confirms the conformity with the mentioned directives, but does not guarantee any product characteristics. The safety direc-
tives of the product documentation must be taken into account. This declaration of conformity is in accordance with the European Standard
EN ISO/IEC 17050-1:2004-10 "Conformity assessment – Supplier's declaration of conformity – Part 1: General requirements".

CE_Declaration_of_conformity_2021.indd / rev. 4 / 06.12.2021 / TK

CONTRINEX AG Industrial Electronics
Route du Pâqui 5 – P.O. Box – CH-1720 Corminboeuf – Switzerland – Tel: +41 26 460 46 46 – Fax: +41 26 460 46 40 – Internet: www.contrinex.com – E-mail: info@contrinex.com

**EG-Konformitätserklärung
Déclaration de conformité CE
EC-Declaration of Conformity**

Nr. / No / No. 2021_409

**Wir
Nous
We****CONTRINEX SA, route du Pâqui 5, CH-1720 Corminboeuf***(Name und Anschrift des Anbieters / Nom et adresse du fournisseur / Supplier's name and address)*

erklären in alleiniger Verantwortung, dass die Produkte
déclarons sous notre propre responsabilité, que les produits
declare under our sole responsibility that the products

**Sicherheits-Lichtvorhänge
Barrières de sécurité
Safety light curtains****YBES***(Bezeichnung, Typ oder Modell / Norm, type ou modèle / Name, type or model)*

mit folgender(en) europäischen Richtlinie(n) übereinstimmen:
est (sont) conforme(s) avec la (les) directive(s) européenne(s) suivante(s) :
conform(s) to the following European standard(s):

**Low Voltage Directive 2006/95/EC
EMC Directive 2014/30/UE
RoHS Directive No. 2011/65/EU
European Directive on Safety of Machinery 2006/42/EC
Radio Equipment Directive, RED 2014/53/EU**

Dies wird nachgewiesen durch die Einhaltung folgender Norm(en):
Ceci est démontré par la conformité à (aux) norme(s) suivante(s) :
This is documented in accordance with the following standard(s):

IEC 61496-1:2012	IEC 61508-1:2010
EN 61496-2:2013	IEC 61508-2:2010
IEC 61496-2:2013	IEC 61508-3:2010
EN ISO 13849-1:2015	EN 300 328 – V2.1.1
EN 61000-6-4:2007	EN 301 489-01 – V2.1.1
IEC 62061:2005+A2:2015	EN 301 489-17 – V3.1.1
EN 62479:2011-09	EN 62368-1:2014+AC:2015+A11:2017

Notifizierte Stelle / Organisme notifié / Notified body:

**TÜV Süd Product Service GmbH, Ridlerstrasse 65, DE-80339 München
Certificate No. Z10 066037 0014****Corminboeuf, 06.12.2021***(Ort und Datum der Ausstellung /
Lieu et date de délivrance /
Place and date of issue)*Genilloud Laurent
2021.12.21 07:31:52
+01'00'*(Name und Unterschrift oder gleichwertige Kennzeichen
des (der) Befugten / Nom et signature ou identification
équivalente de (des) autorisé(s) / Name and signature or
equivalent identification of authorized person(s))*

Diese Konformitätserklärung entspricht der Europäischen Norm EN ISO/IEC 17050-1:2004-10 «Konformitätsbewertung – Konformitätserklärung von Anbietern – Teil 1: Allgemeine Anforderungen».

Cette déclaration de conformité est basée sur la norme européenne EN ISO/CEI 17050-1:2004-10 «Évaluation de la conformité – Déclaration de conformité du fournisseur – Partie 1 : Exigences générales».

This declaration of conformity is in accordance with the European Standard EN ISO/IEC 17050-1:2004-10 "Conformity assessment – Supplier's declaration of conformity – Part 1: General requirements".



CONTRINEX

ALL OVER THE WORLD

EUROPE

Austria
Belgium
Croatia
Czech Republic
Denmark
Estonia
Finland
France*
Germany*
Great Britain
Greece
Hungary
Ireland
Italy*
Luxembourg
Netherlands
Norway
Poland
Portugal*
Romania
Russian Federation

Serbia
Slovakia
Slovenia
Spain
Sweden
Switzerland*
Turkey
Ukraine

AFRICA

Morocco
South Africa

THE AMERICAS

Argentina
Brazil*
Canada
Chile
Mexico*
Peru
United States*

ASIA

China*
India*
Indonesia
Japan*
Korea
Malaysia
Pakistan
Philippines
Singapore
Taiwan
Thailand

MIDDLE EAST

Israel
United Arab Emirates

AUSTRALASIA

Australia
New Zealand

*Contrinex subsidiary

Terms of delivery and right to change design reserved.
Please check our website for updates.

900 215 002/D/08.22

HEADQUARTERS

CONTRINEX Industrial Electronics
Route du Pâqui 3 – PO Box – CH 1720 Corminboeuf – Switzerland
Tel: +41 26 460 46 46 – Fax: +41 26 460 46 40
Internet: www.contrinex.com – E-mail: info@contrinex.com

www.contrinex.com