

WTOR-4

WIFI/Serial
Gateway



User Manual

Klemmsan[®]

TABLE OF CONTENTS

SECTION 1 GENERAL INFORMATION4

- 1.1 General Information5
- 1.2 Proper Use and Safety Conditions..... 6

SECTION 2 DEVICE FEATURES7

- 2.1 Device Definitions 8
- 2.2 Connections 9
- 2.3 Operating Mode 10
 - 2.3.1 AP (Access Point) Mode..... 10
 - 2.3.2 STA (Station) Mode..... 11

SECTION 3 WEB INTERFACE12

- 3.1 Device Configuration 14
- 3.2 AP (Access Point) settings:..... 15
- 3.3 STA (Station) Settings:..... 16
 - 3.3.1 Gateway Settin 16
 - 3.3.2 Network Setting 17
- 3.4 Communication Settings:..... 18
 - 3.4.1 WIFI Interface - Gateway MODBUS Request Settings:..... 19
 - 3.4.2 Serial Interface - Gateway MODBUS Response Settings 19
- 3.5 Saving Settings..... 20
- 3.6 Security Configuration: 20
- 3.7 Device Info 21

SECTION 4 TECHNICAL SPECIFICATIONS22

FIGURES

- Figure 2-1 Definitions on WTOR 8
- Figure 2-2 Antenna 9
- Figure 2-3 AP (Access Point) Mode..... 10
- Figure 2-4 Wireless Connection 10
- Figure 2-5 Station Mode..... 11
- Figure 3-1 Authentication Screen..... 13
- Figure 3-2 AP (Access Point) Dashboard 13
- Figure 3-3 STA (Station) Dashboard 14
- Figure 3-4 Operating modes 14

Figure 3-5	AP Mode - Progress indicator.....	15
Figure 3-6	STA Mode - Progress indicator.....	15
Figure 3-7	Access Point Settings Screen.....	15
Figure 3-8	Station Settings Screen	16
Figure 3-9	Gateway settings	16
Figure 3-10	Network settings	17
Figure 3-11	Communication Settings Panel.....	18
Figure 3-12	Confirmation	20
Figure 3-13	Restart Info.....	20
Figure 3-14	Security Page	20
Figure 3-15	Device Info	21

TABLES

Table 1-1	Supported Protocols	5
Table 3-1	Default Communication Settings.....	18



WTOR-4

WIFI/Serial
Gateway

**SECTION 1
GENERAL
INFORMATION**

SECTION 1 GENERAL INFORMATION

1.1 General Information

WTOR series products; serial MODBUS devices to efficiently connect to IP-based systems over a Wi-Fi network. It provides a flexible and powerful structure for industrial MODBUS communication with many serial and gateway settings. WTOR works as a server in Access point and Station modes.

Wtor can create WI-FI network while running in AP(Access Point) mode. This feature allows WTOR to be used in places where there is no Wi-Fi network. A single device can join the Wi-Fi network created by WTOR. Serial devices can be controlled and monitored in this way.

In STA (Station) mode, WTOR can join an external Wi-Fi router to connect the serial devices to the existing Wi-Fi network. Serial devices can be controlled and monitored in this way. WTOR allows 7 gateways and 1 WEB interface connection.

It allows configuration via WEB interface (AP and STA modes) without requiring an external program.

Table 1-1 Supported Protocols

REQUEST		RESPONSE	
WIFI		SERIAL	
Protocol	MODBUS TCP	Protocol	MODBUS RTU
	MODBUS RTU over TCP		MODBUS ASCII
	MODBUS ASCII Over TCP		

WTOR converts MODBUS TCP or MODBUS RTU over TCP and MODBUS ASCII Over TCP queries received via WI-FI to MODBUS RTU and MODBUS ASCII queries and sends them to serial devices via built-in RS485 / RS232 interface. The response from the serial devices is converted to the request protocol and sends it to the querying device (master) via TCP / IP. LEDs on the device shows a lot of information such as power, operating modes, communication status.

1.2 Proper Use and Safety Conditions

- Installation and connections should be established in accordance with the instructions set out in the manual by authorized persons. Unless the connection is built properly, device should not be operated.
- Before wiring the device up, make sure that energy is cut off.
- Use a dry cloth to remove the dust from the device/clean the device. Avoid using alcohol, thinner or a corrosive material.
- Device should be engaged only after all the connections are made.
- Do not open the inside of the device. There are no parts which the users can intervene inside.
- Device should be kept away from humid, wet, vibrant and dusty environments.



The manufacturing company may not be kept responsible for unfavorable incidents that arise out of the failure to follow the above cautions.



WTOR-4

WiFi/Serial
Gateway

**SECTION 2
DEVICE
FEATURES**

SECTION 2 DEVICE FEATURES

2.1 Device Definitions



Figure 2-1 Definitions on WTOR

DC-,DC+ Input:

Wtor is powered on from DC-, DC+ input. 11 ... 30V AC/DC must be applied.

RST Button:

Pressing briefly (<5 sec) starts the device. When pressed for a long time

(≥ 5 sec) the device restarts to AP mode, AP mode and security settings return to their default

values. The device configuration is as follows:

Operating mode: AP (Access Point)

SSID: WTOR4_XXXXXXXX (XXXXXXXX: Serial Number)

Security Type: WPA

Password: wtor1234

Domain Name: www.wtor4.net

WEB page entrance;

User Name: admin

Password: admin

RS485 Port:

Provides communication with devices that support the Modbus protocol.

Antenna:

The SMA type connection where the external antenna connection is made.

ON LED:

When power is supplied from DC-, DC + input, ON LED lights up

AP LED:

When the LED is lit in flasher mode, WTOR is prepared to operate in AP mode. While the LED is flashin , the device that will join the Wi-Fi network is waiting. When a device joins WTOR's Wi-Fi network, the LED will always light up. When the RST button is pressed, the AP LED and STA LED will blink at the same time.

STA LED:

When the LED is lit in the flasher mode, the WTOR is preparing to operate in the STA mode. When the WTOR joins the defined Wi-Fi network, the LED will always light up. When the RST button is pressed, the AP LED and STA LED will blink at the same time.

RX LED:

The WTOR will scan for 5 seconds at startup to see if the Micro-USB cable is plugged in, and the RX LED flashes during this time. If the Micro-USB cable is plugged in, the RX LED is always on. If the micro-USB cable is not plugged in, the RX LED goes out. It means that when the LED is on, the data from the serial device comes to the WTOR while the WTOR is performing its essential functions.

TX LED:

The WTOR will scan for 5 seconds at startup to see if the Micro-USB cable is plugged in, and the TX LED flashes during this time. If the Micro-USB cable is plugged in, the TX LED is always on. If the micro-USB cable is not plugged in, the TX LED goes out. It means that when the LED is on, the data from the WTOR comes to the serial device while the WTOR is performing its essential functions.

2.2 Connections

Supply voltage should be applied to WTOR within the range of 11 ... 30VDC.

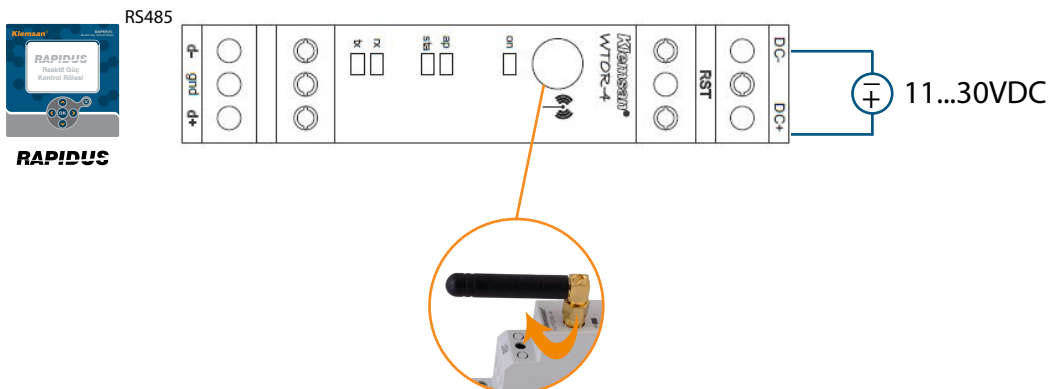

Figure 2-2 Antenna

2.3 Operating Modes

WTOR has 2 different operating modes.

2.3.1 AP (Access Point) Mode:

Where there is no established Wi-Fi network, the WTOR may create a Wi-Fi network. A single device can join the Wi-Fi network created by WTOR. Serial devices can be controlled and monitored in this way. To participate in WTOR in AP mode, it is necessary to join WTOR_XXXXXXXX (XXXXXXXX: Serial Number) to SSID from the computer's connection settings. WTOR's WiFi encryption is WPA2 and the password is "wtor1234".

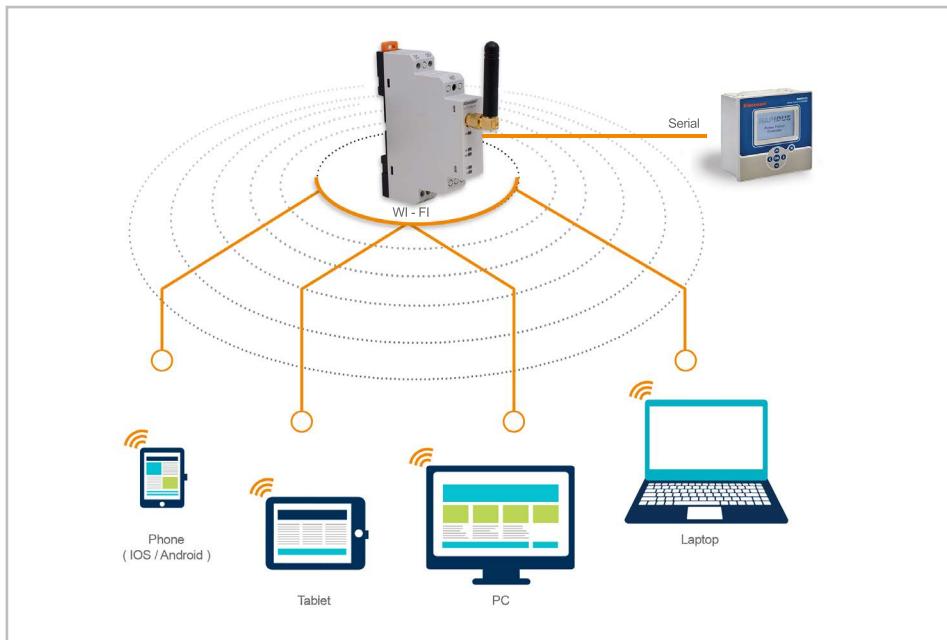

Figure 2-3 AP (Access Point) Mode

WTOR works in AP mode as the factory default value. It is necessary to join the WTOR network in order to make the settings. After joining the network, the configuration page can be accessed from the WEB browser with the IP address 192.168.1.1. The default password is "wtor1234".

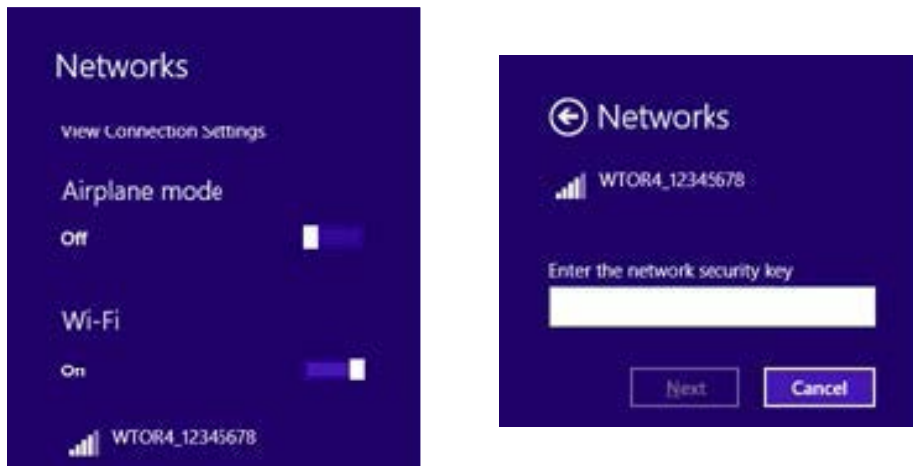

Figure 2-4 Wireless Connection

2.3.2 STA (Station) Mode:

STA (Station-Station) Mode: Joins an external Wi-Fi router to connect serial devices to the existing Wi-Fi network. This way the serial devices can be controlled and monitored. The configuration page can be accessed by entering the IP address set for WTOR in the WEB browser of a computer joined to the same network, and the desired configuration settings can be made.

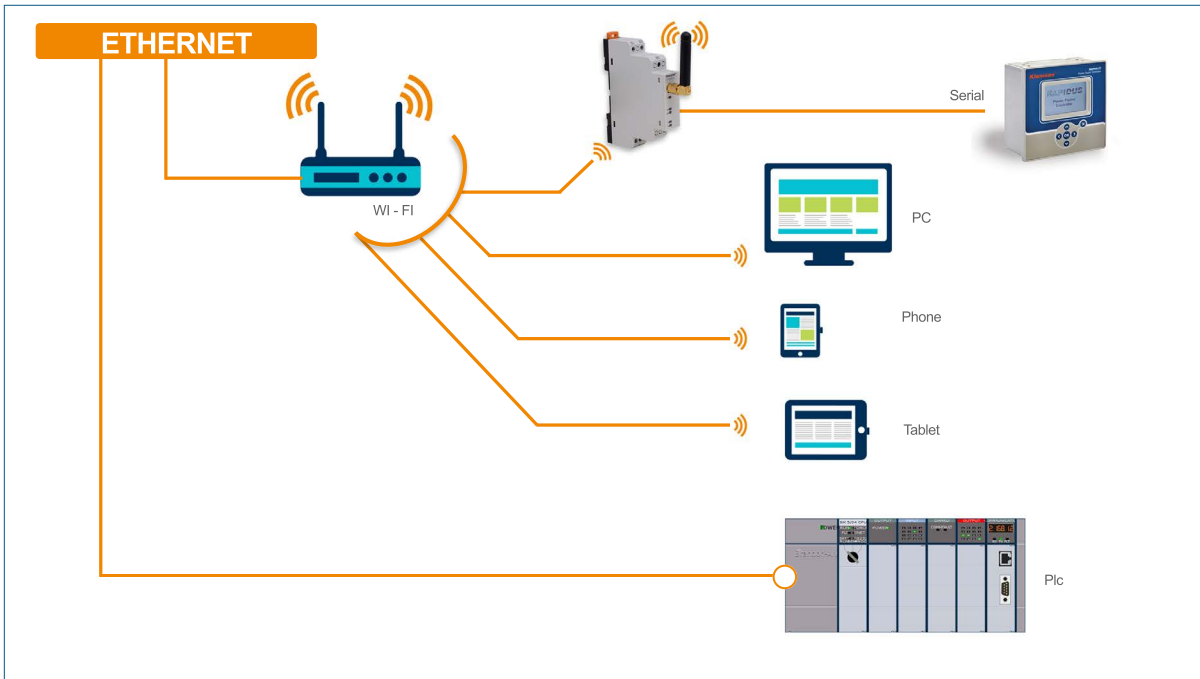

Figure 2-5 Station Mode



WTOR-4

WIFI/Serial
Gateway

SECTION 3
WEB INTERFACE

SECTION 3 WEB INTERFACE

The WTOR web interface is software that runs on the embedded web server where all the configuration settings of the WTOR series products can be made. To access the web interface, any device with an internet browser installed, including tablets and smartphones, can be used.



WTOR works in AP mode as the factory default value. It is necessary to join the WTOR network in order to make the settings. After joining the network, the configuration page can be accessed from the WEB browser with the IP address 192.168.1.1.

WTOR can be configured via WEB in AP and STA modes. The “User Name” and “Password” information required to open the configuration page must be entered correctly.

Figure 3-1 Authentication Screen

Once the “User Name” and “Password” information has been entered, the WTOR Web page will be accessed. The first opening page is the “Dashboard” page. This page provides informations about the current WTOR configuration.

Figure 3-2 AP (Access Point) Dashboard

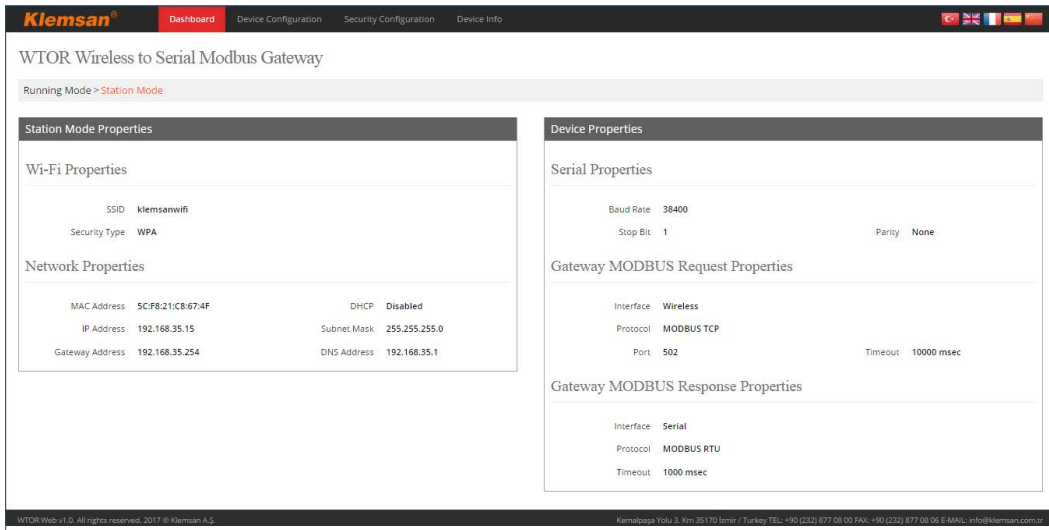

Figure 3-3 STA (Station) Dashboard

WTOR WEB page supports 5 different language values. The desired language can be selected by pressing the flag on the page .

3.1 Device Configuration

If any configuration changes are to be made in the WTOR, the “Device Configuration” tab should be selected. When “Device Configuration” is selected, the operating mode (“Access Point” and “Station”) will be selected in the first page to be opened. For existing mode only ‘Change Current Mode’ option will be active.

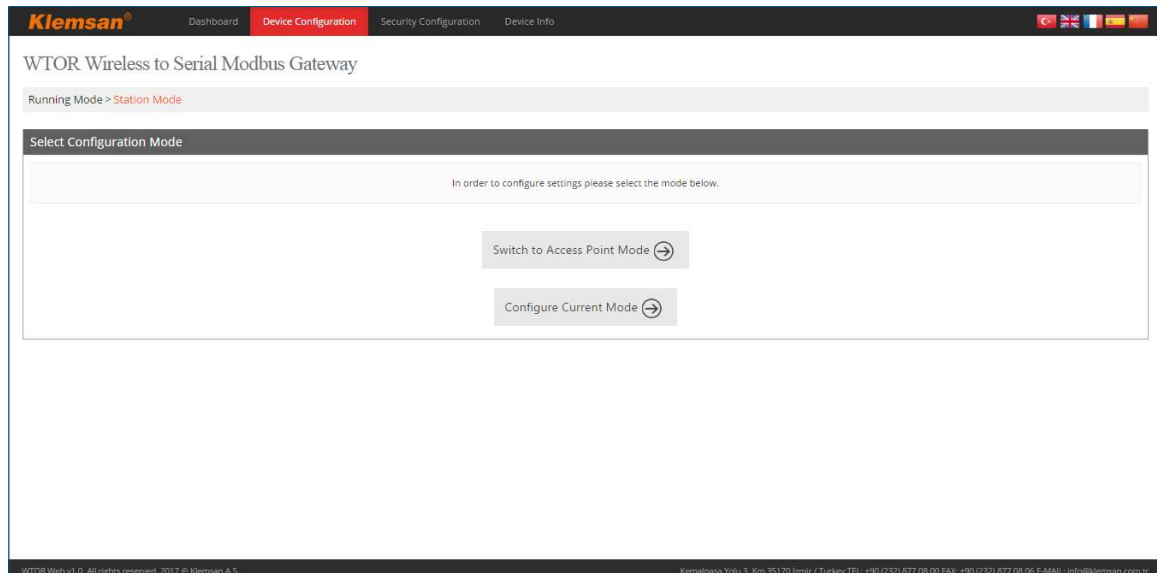

Figure 3-4 Operating modes

Depending on the selected mode of operation, the WEB page will be redirected to the AP or STA mode settings screen.

Web-based configuration software is progressing in a sequential manner. After the device mode is selected, the progress indicator on the page informs the user by showing the progress of the configuration process.

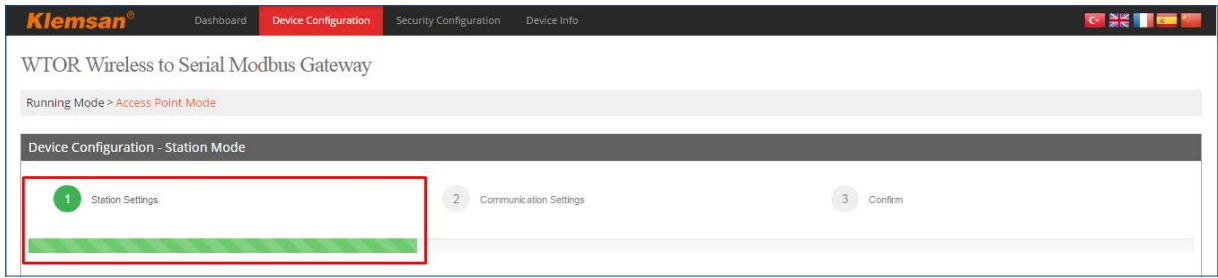

Figure 3-5 AP Mode - Progress indicator

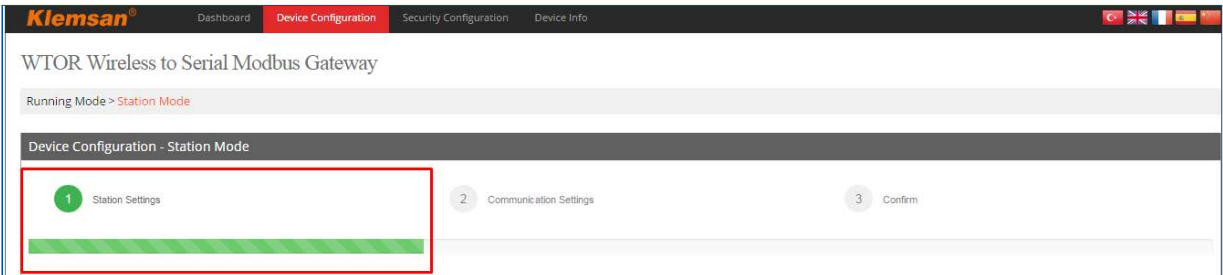

Figure 3-6 STA Mode - Progress indicator

3.2 AP (Access Point) settings:

In this tab, the access point settings of WTOR are made. The WTOR's default access point settings are:

Service Set ID (SSID): WTOR_XXXXXXXX (XXXXXXXX = serial number)

Security Type: WPA

Channel: 6

Domain Name: www.wtor4.net

HTTP WEB Port: 80

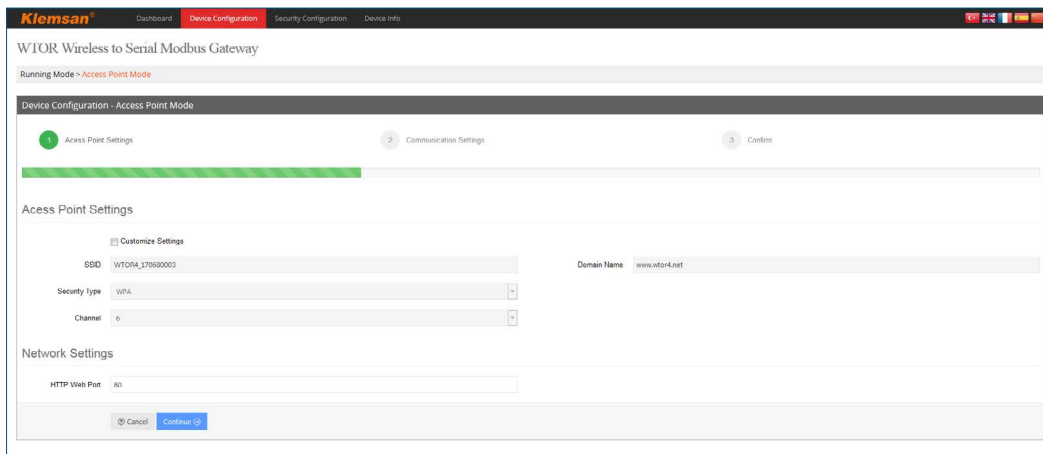

Figure 3-7 Access Point Settings Screen

If you only want to change the HTTP WEB port or go to the next page without any changes to the access point settings, the "Customize Settings" button should be inactive. But if you want to change the access point settings, the button should be checked.

(SSID): WTOR's service set ID in AP mode.

Security Type: Security protocol and certificate programs developed to secure wireless networks. "Open" (unprotected), WEP or WPA can be selected.

Channel: Selecting a Wi-Fi channel will help reduce interference and boost your Wi-Fi signal.

Domain Name: The WTOR configuration page in AP mode can be accessed by entering the domain name 'www.wtor4.net' into the WEB browser as well as from the IP address 192.168.1.1.

HTTP WEB Port: This is the port number that provides access to WEB page. The port 80 is the predefined HTTP WEB port. If it is changed, it should be entered in "IP Address: PortNumber" format.

3.3 STA (Station) Settings:

If WTOR is to be operated in station mode, the network-related settings that WTOR will join are made in this tab.

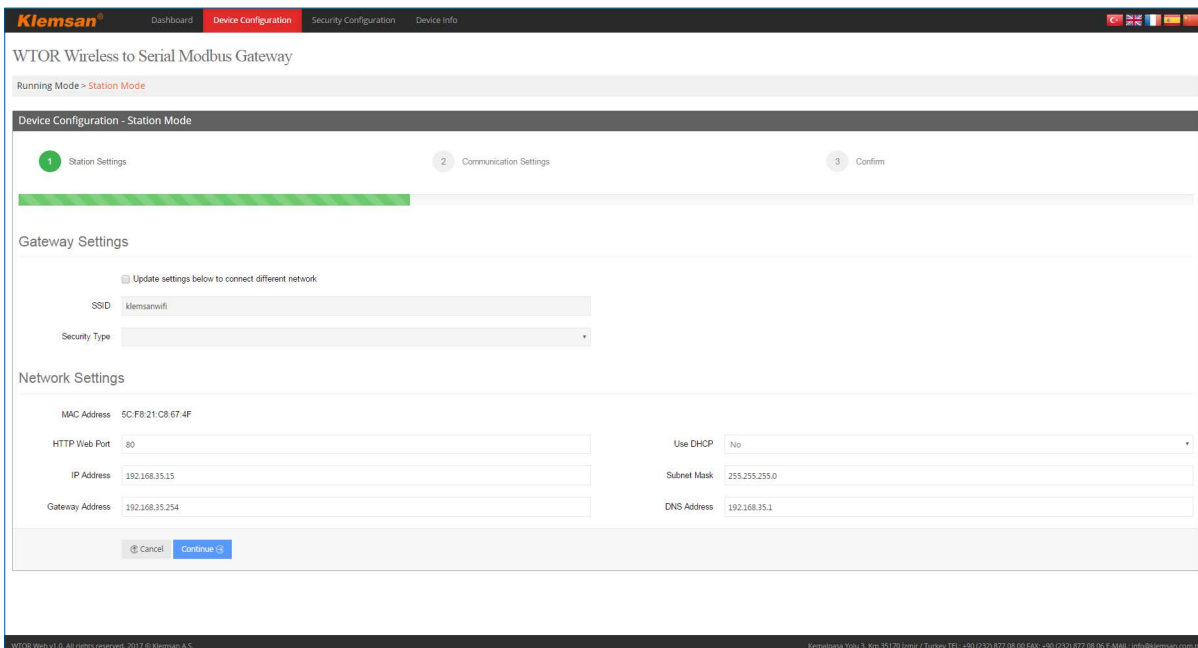

Figure 3-8 Station Settings Screen

3.3.1 Gateway Settings:

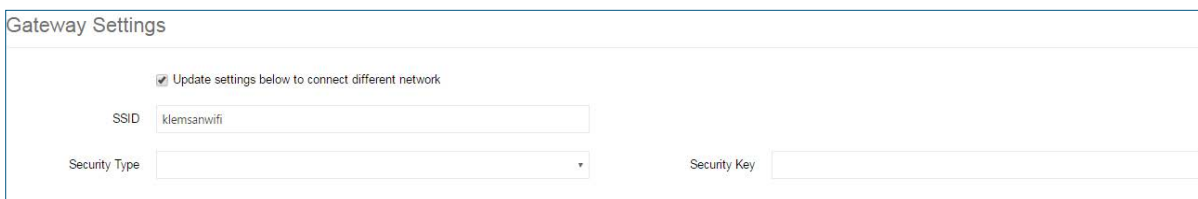

Figure 3-9 Gateway settings

If the station mode is set for the first time, or if WTOR wants to join a different network, the "Update settings below to connect different network" button must be selected. However, if different settings are updated over the same network, this button should be inactive.

(SSID): 'Service set ID' of network that WTOR will be join

Security Type: The encryption type of the network that WTOR will join. Open (unprotected), WEP, WPA1 or WPA2 can be selected.

Security Key: The password for the network that WTOR will join. If Open (unprotected) is selected, this variable will become inactive.

3.3.2 Network Settings:

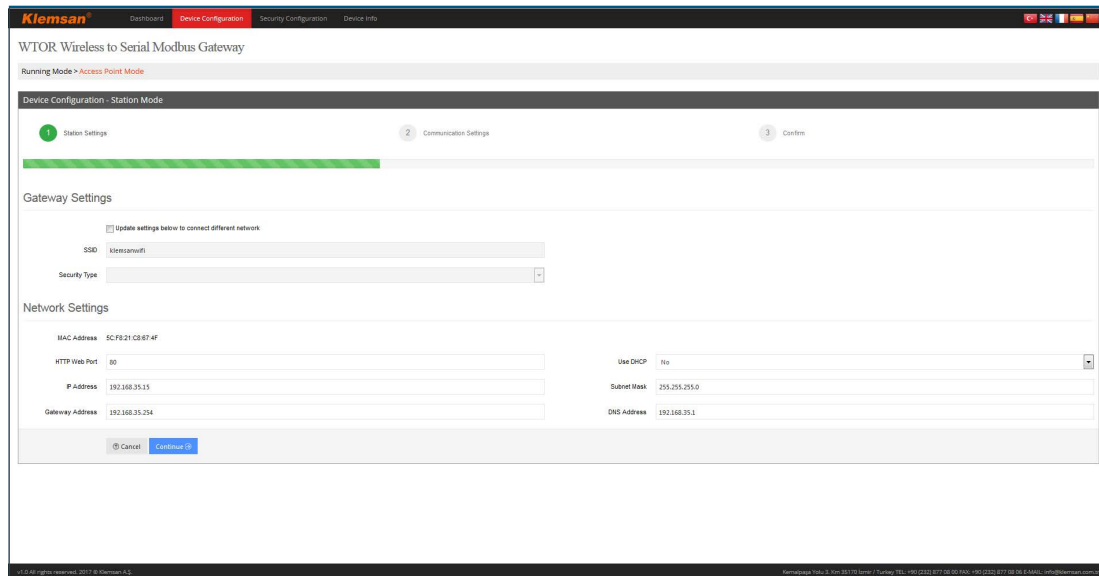

Figure 3-10 Network settings

MAC Adresi: Represents the physical address of the network for each device that can connect to the network. Devices are assigned by the manufacturer during production and can not be changed by the user. Even if it is the same brand and model, the MAC address has to be different for each device. The MAC address is a 48-bit value. They are usually displayed in 16-point format.

HTTP WEB Port: This is the port number that provides access to WEB page. The port 80 is the predefined HTTP WEB port. If it is changed, it should be entered as IPAddress: PortNumber. For example, 192.168.35.15:90

IP Address: The address that a networked device receives in the network. It is a form of logical addressing, not physical. There can be many devices with the same IP address provided they are on different networks. IP addresses can be changed by the user. In the IPv4 standard, IP addresses are represented by 4 bytes. They are generally displayed as follows in a 10-point number format. Example: 192.168.35.15

Default Gateway: A gateway is a networking hardware that is connected to the local area network (LAN) and the wide area network (WAN) at the same time. There are different IP addresses in the local area network and the wide area network. The gateway address is the IP address of the network's local area network. Data packets forwarded to this IP address are processed in the gateway and transferred to the wide area network.

Network Subnet Mask: Used to determine whether two IP addresses are on the same network. Use DHCP: WTOR’s network settings can be configured in two different ways. First, if this option is “Yes”, WTOR automatically receives the appropriate settings for the network it is connected to. Second, if this option is “No”, the IP address, gateway address and subnet mask must be entered by the user in the appropriate fields that are compatible with the network to which the WTOR is connected. If “Yes” is selected, “IP address”, “Network Subnet Mask”, “Default Gateway” and “DNS Address” settings will not be displayed.

DNS Address: Domain name is the address of the server. It should be set as the default gateway.

3.4 Communication Settings:

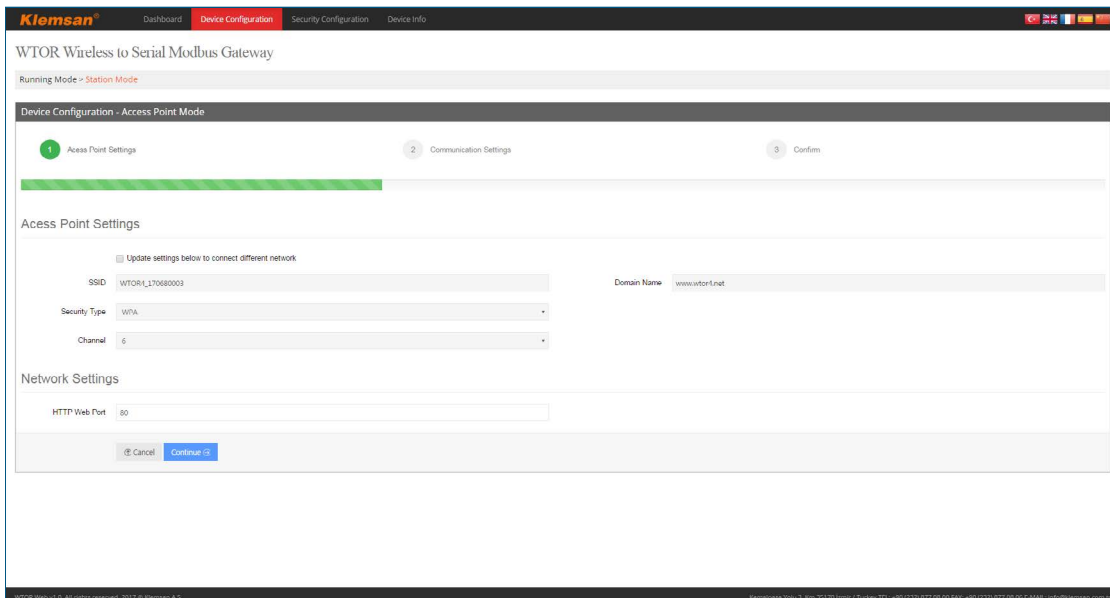

Figure 3-11 Communication Settings Panel

Serial communication settings: In this tab, the serial communication settings of WTOR are made. The values in this tab must be selected according to the serial interfaces of the MODBUS network. If these values are not set according to the MODBUS network, a healthy serial communication will not occur. The default serial communications settings for WTOR are:

Table 3-1 Default Communication Settings

Baud Rate	38400
Stop Bit	1
Parity	None

Baud Rate: WTOR supports; 300, 600, 1200, 2400, 4800, 9600, 19200, 38400, 57600 and 115200 baud rates.

Stop Bit: WTOR supports 1 and 2 stop bits.

Parity: None, even, odd



3.4.1 WIFI Interface - Gateway MODBUS Request Settings:

In this tab, the WTOR query side gateway settings are made. WTOR's query-side default gateway settings are:

Protocol: MODBUS TCP

Port: 502

Timeout: 10000

Timeout interval: milliseconds

Protocol: The type of MODBUS queries that are sent to the WTOR over the wireless network is determined by this field. "MODBUS TCP", "MODBUS RTU over TCP" and "MODBUS ASCII over TCP" protocols are selected.

Port: Port to which WTOR will listen.

Timeout Period: In server mode, if a new query does not arrive in WTOR until the "timeout" interval on the query side has expired, the WTOR breaks the TCP connection which the query sending machine and allocates resources for new TCP connections. If the time between two queries is greater than the timeout shown on the query side, a new TCP connection must be opened before the query is sent."

Timeout Interval: Specifies the type of timeout period. It can be selected as "seconds" or "milliseconds".

3.4.2 Serial Interface - Gateway MODBUS Response Settings:

Protocol: MODBUS RTU

Timeout : 1000

Timeout interval: milliseconds

Protocol: The type of MODBUS responses to the WTOR via the serial connection is determined by this field. One of the "MODBUS RTU" and "MODBUS ASCII" protocols is selected.

Timeout: WTOR's response time from each device in the MODBUS network. If no response is received from the querying device during this time, pass to the next remote connection query.

Timeout Interval: Specifies the type of timeout period. It can be selected as "seconds" or "milliseconds".

3.5 Saving Settings

After “Device Settings” is done, “Submit” button must be pressed to record the changes made.

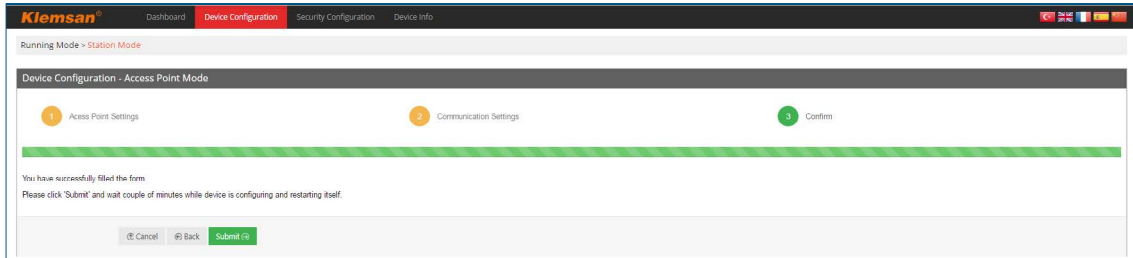

Figure 3-12 Confirmation

Changes made after the “Submit” button is pressed are sent to the WTOR and the WTOR starts again. In the meantime, the following screen will appear on the screen.

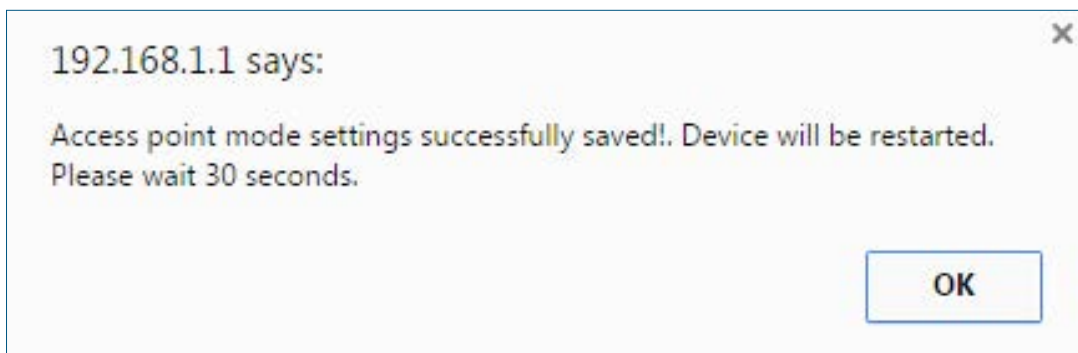

Figure 3-13 Restart Info

3.6 Security Configuration:

In this tab, the “User Name” and “Password” information that is requested at the entrance of WORT WEB page are set.

The default settings for WTOR are as follows:

User Name: admin

Password: admin

User Name: This is the username to be entered during login to WEB page.

New Password: This is a new password to be entered during login to WEB page. New Password

(Repeat): Enter the password to check the new password during login to the WEB page. If the “Submit” button is pressed on the screen that appears when the “Continue” button is pressed, the new user name and password will be saved to WTOR and WTOR will start again.

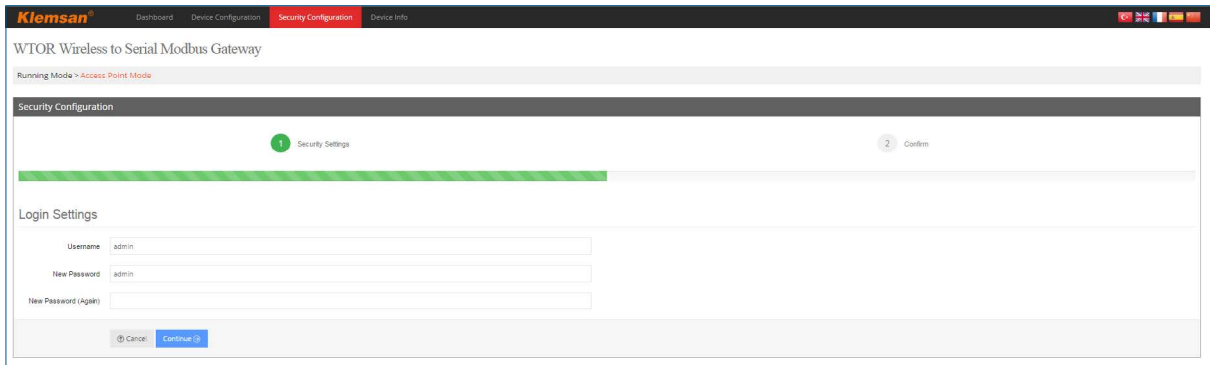

Figure 3-14 Security Page

3.7 Device Info

It is the page that has WTOR's product name, serial number, software version, hardware version, date of production, etc.

About	Klemsan[®]
Product	WTOR4
Serial Number	12345678
Firmware Version	1.00
Hardware Version	1.2.1
Build Date	27.10.2016

Figure 3-15 Device Info



WTOR-4

WIFI/Serial
Gateway

**SECTION 4
TECHNICAL
SPECIFICATIONS**

SECTION 4 TECHNICAL SPECIFICATIONS

SUPPLY

Voltage 11-30VDC from DC+,DC- terminals

Power Consumption..... <1.2W and <2.2VA

Working Temperature..... -10...60 °C

Isolation.....1.5kV RMS

WI-FI FEATURES

Standard..... 802.11b/g/n

Network Mode..... AP/ Station

Transmission Power..... 18.0 dBm @ 1DSSS, 14.5 dBm @ OFDM

Receiver Sensitivity..... -95.7 dBm @ 1DSSS, -74.0 dBm @ OFDM

RF Model..... DSSS / OFDM

Security Type..... WPA2

SERIAL COMMUNICATION

Supports for up to 64 devices

Baudrate..... 600, 1200, 2400, 4800, 9600, 19200, 38400, 57600,

115200 Stop Bit..... 1,2

Parity..... None, Even,Odd

Data..... 8 Bit

Supported Protocols

MODBUS TCP

MODBUS RTU over TCP

MODBUS ACII over TCP

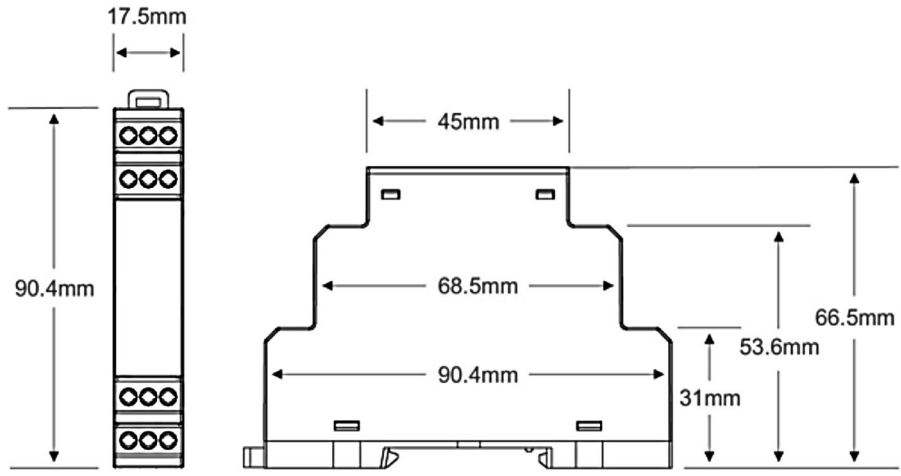

Şekil 4-1 Dimensions

