



LogBox Wi-Fi

INSTRUCTION MANUAL V3.0x A



Applies to devices with firmware version starting with V3.0x.





1.	SAFETY ALERTS.....	4
2.	INTRODUCTION.....	5
3.	DISPLAY AND NAVIGATION.....	6
3.1	DISPLAY INFORMATION.....	6
3.2	OPERATION KEYS.....	7
3.3	NAVIGATION SCREENS.....	7
4.	OPERATION AUTONOMY.....	14
5.	INPUT SIGNALS READING.....	15
5.1	ANALOG INPUTS.....	15
5.1.1	MEASUREMENT AND INDICATION OF INPUT TYPES.....	16
5.2	DIGITAL INPUT.....	18
5.2.1	PULSE COUNT.....	18
5.2.2	EVENT LOG.....	19
5.2.3	LOGS CONTROL.....	20
6.	DIGITAL OUTPUT.....	21
7.	COMMUNICATION WITH NOVUS CLOUD.....	22
8.	MQTT PROTOCOL.....	23
8.1	PUBLICATION TOPICS.....	23
8.1.1	STATUS TOPICS.....	23
8.1.2	LOGS TOPICS.....	23
8.1.3	CONFIGURATION TOPIC.....	23
8.1.4	RESPONSE TOPIC.....	23
8.1.5	IDENTIFICATION TOPIC.....	23
8.2	INSCRIPTION TOPIC.....	24
8.3	FRAME PARAMETERS.....	25
8.3.1	TIMESTAMP.....	26
8.4	MQTT PROTOCOL CONFIGURATION IN SOFTWARE NXPERIENCE.....	26
8.4.1	QOS.....	26
8.4.2	JSON FORMAT.....	26
8.4.3	BOOLEAN FORMAT.....	27
9.	MODBUS-TCP PROTOCOL.....	28
9.1	COMMANDS.....	28
9.1.1	READ HOLDING REGISTERS – 0X03.....	28
9.1.2	WRITE HOLDING REGISTERS – 0X06.....	28
9.1.3	WRITE MULTIPLE HOLDING REGISTERS – 0X16.....	28
9.2	REGISTERS TABLE.....	28
10.	SMTP PROTOCOL.....	33
11.	DATA LOGGING.....	35
12.	ALARMS.....	36
13.	CONFIGURATION SOFTWARE.....	37
13.1	NXPERIENCE.....	37
13.2	NXPERIENCE MOBILE.....	37
13.3	CONFIGURING LOGBOX WI-FI WITH NXPERIENCE.....	37
13.3.1	GENERAL PARAMETERS.....	37
13.1.2.1	INFORMATION.....	37
13.1.2.2	DISPLAY.....	37
13.1.2.3	CLOCK.....	38
13.3.2	ANALOG CHANNELS PARAMETERS.....	38
13.1.2.1	CUSTOM CALIBRATION.....	39
13.3.3	DIGITAL CHANNEL PARAMETERS.....	39
13.1.3.1	"PULSE COUNT" MODE.....	39
13.1.3.2	"EVENT LOG" OR "LOGS CONTROL" MODE.....	42
13.3.4	CHANNELS GENERAL PARAMETERS.....	43
13.3.5	LOG CONFIGURATION.....	43
13.1.5.1	LOGS.....	44
13.1.5.2	START MODE.....	44
13.1.5.3	STOP MODE.....	44
13.3.6	COMMUNICATION PARAMETERS.....	45
13.1.6.1	WI-FI CONFIGURATION.....	45
13.1.6.2	MODBUS-TCP PROTOCOL.....	46
13.1.6.3	MQTT PROTOCOL.....	46
13.1.6.4	NOVUS CLOUD CONFIGURATION.....	47

13.1.6.5	SMTP PROTOCOL	48
13.3.7	ALARMS CONFIGURATION	49
13.1.7.1	COMPARISON BETWEEN CHANNELS	51
13.4	DIAGNOSTICS	51
13.4.1	LOGS	51
13.4.2	CHANNELS	52
13.4.3	ALARMS	52
13.4.4	COMMUNICATION	53
13.4.5	MISCELLANEOUS	53
13.5	NXPERIENCE MOBILE SPECIFIC FEATURES	54
13.5.1	INSTALLING THE APPLICATION	54
13.5.2	OPERATION OF THE APPLICATION	54
13.5.3	DOWNLOAD LOGS	54
13.5.3.1	CHART	57
13.5.3.2	LOG SCREEN OPTION MENU	57
13.5.3.3	SHORTCUTS MENU	59
13.5.3.4	PREFERENCES	60
13.5.1	MONITORING	61
13.5.4.1	MONITORING	61
13.5.4.2	ANDROID NOTIFICATIONS	61
13.5.4.3	ALARMS	62
13.5.4.4	STATUS	63
13.5.2	FILE MANAGER	64
14.	INSTALLATION	68
14.1	MECHANICAL INSTALLATION	68
14.1.1	DIMENSIONS	69
14.2	ELECTRICAL INSTALLATION	70
14.2.1	INSTALLATION RECOMMENDATIONS	70
14.2.2	SPECIAL PRECAUTION	70
14.2.3	ELECTRICAL CONNECTIONS	70
14.2.3.1	POWER SUPPLY	70
14.2.3.2	DIGITAL OUTPUT	71
14.2.3.3	DIGITAL INPUT	71
14.2.3.4	ANALOG INPUTS	72
15.	COMMUNICATION INTERFACES	74
15.1	USB	74
15.2	WI-FI	74
16.	FIRMWARE UPDATE	75
16.1	FIRMWARE UPDATE VIA USB	75
16.2	OVER THE AIR (OTA) FIRMWARE UPDATE	75
17.	CFR 21 REGULATION	76
17.1	SUPPORT FOR CFR 21 PART 11 AND RDC 17:2010 VALIDATION	76
18.	TROUBLESHOOTING	77
18.1	START/STOP MODES	77
18.2	CLOCK	77
18.3	ALARM INFORMATION	77
18.4	ANALOG INPUTS	77
18.5	UNREGISTERED ALARMS	77
18.6	COMMUNICATION LINK LOSS	77
18.7	PROBLEMS COMMUNICATING WITH THE DEVICE VIA USB INTERFACE	77
18.8	PROBLEMS DURING FIRMWARE UPDATE VIA USB INTERFACE	79
19.	TECHNICAL SPECIFICATIONS	81
19.1	SENSORS RANGE AND ACCURACY	82
19.2	WIRELESS CONNECTIVITY	83
19.3	CERTIFICATIONS	84
20.	WARRANTY	85

1. SAFETY ALERTS

The symbols below are used throughout this manual to draw the user's attention to important information regarding safety and use of the device.

		
CAUTION Read the manual fully before installing and operating the device.	CAUTION OR HAZARD Risk of electric shock.	ATTENTION Material sensitive to static charge. Check precautions before handling.

Safety recommendations should be observed to ensure user safety and to prevent damage to the device or system. If the device is used in a manner other than that specified in this manual, the safety protections may not be effective.

2. INTRODUCTION

LogBox Wi-Fi is an electronic wireless data register, also known as a *data logger*, which comprises three analog sensors and one digital sensor, respectively called the "analogue measuring channel" and the "digital measuring channel". With a memory capacity for up to 140,000 logs, it allows the use of batteries, to keep its autonomy and continue to log data even during external power outages. It features a large display that offers a comfortable view of measured variables and general device information. Furthermore, the device's enclosure has a protection cover for the connections, a sealing ring and a holder that allows its attachment to a wall or metal surface by means of the optional bracket with magnetic inserts.

The analog inputs accept any type of temperature sensor, such as thermocouples, Pt100 or sensors for any other quantities with current or voltage signals. The digital channel can log the time of events, such as opening a door, or counting pulses from a flow sensor. **LogBox Wi-Fi** also has the following internal sensors: temperature, battery voltage, and external power supply voltage, which can also log the values in the memory, taking the place of any of the available measurement channels. Its wide display allows you to view up to three variables simultaneously, and displays indications such as alarms, communication status, enabled channels, battery voltage level, among other information.

LogBox Wi-Fi also has a buzzer for audible alerts and a digital output that can be used as an alarm output or as an electronic key to power sensors and can be controlled by several protocols, such Modbus-TCP and MQTT, for example.

All device configurations can be accessed by user via desktop or notebook connected to **LogBox Wi-Fi** USB interface or through an Android or iOS smartphone. For use with computers, **NOVUS** provides the **NXperience** software on the website download area. For users with smartphone, **NOVUS** makes the **NXperience Mobile** application available on *Google Play Store* or *App Store* (iOS). Both software tools allow log configuration, data download, and analysis.

3. DISPLAY AND NAVIGATION

3.1 DISPLAY INFORMATION

LogBox Wi-Fi has an LCD display with 3 numerical lines of 4 ½ digits, to display the current value of all enabled channels, as well as the minimum and maximum values thereof. At the same time, it is possible to display the current value of up to three analog channels and, in a second screen, if enabled, the digital input current value. In addition to channel information, **LogBox Wi-Fi** has 7 screens with a variety of information and features and 24 symbols that allow for easy information visualization and diagnostics.

See below an illustration of the display with a description of each symbol's functionality.

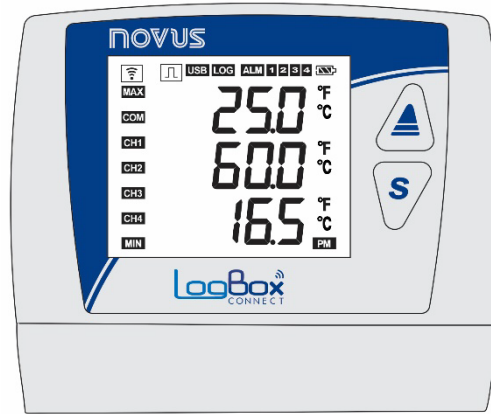











Figure 1 – LogBox Wi-Fi Display Information

- : It remains lit while **LogBox Wi-Fi** has a valid IP on the wireless network to which you are connected. If the device is set to wake up by keyboard, it will remain on while the interface remains available.
- : When the digital channel is disabled, it remains off. When set to "Pulse Count" mode, it will remain on. When set in the "Event Log" or "Logs Control" modes, it will remain lit, flashing when an event is detected at the digital input.
- **USB**: Lights up when the USB cable is connected. Turns off when the USB cable is disconnected.
- **LOG**: It remains lit from the moment the device registers the first log until the moment it stops logging. When set to "Daily" mode, which must start and end daily at a predetermined time, it will remain lit within the set time. It will flash while logging, turn off at the time of a log and restart.
- **ALM**: Lights up and stays on when entering an alarm condition. Turns off when a new configuration is received, or the alarm status is cleared. Indicates to the user that, at some point, an alarm has been triggered.
- **1 2 3 4**: Light up while the alarm conditions of the corresponding channels are satisfied: 1 (analog channel 1), 2 (analog channel 2), 3 (analog channel 3) and 4 (digital channel). When you exit the alarm condition, the flag will be cleared.
- : Indicates the battery voltage level. This symbol is updated next to the log range (even if the device is not logging), with a minimum of 5 minutes. Thus, if the device is configured to log every 1 second, the battery indicator will refresh every 5 minutes. If the logging interval is longer than 5 minutes, the battery indicator will update with the same log range.
 - : Battery over 75 %
 - : Battery over 50 %
 - : Battery over 25 %
 - : Battery below 25 % (provide battery replacement)
- **MAX**: Lights up while the "Maximum" values information reached in each channel are being displayed.
- **COM**: Flashes to inform the receipt of valid data packet from one of the available communication interfaces.
- **CH1 CH2 CH3 CH4**: Indicates which channels are enabled.
- **MIN**: Lights up while the "Minimum" amount of information is being displayed.
- **°F °C**: If the channel unit is set to °F or °C, one of the symbols will light up during channel display. Otherwise, no unit symbol will be displayed.
- **PM**: If the clock is set in the 12-hour format, the PM symbol will light up when the clock is displayed, and the time is later than 1 pm.



3.2 OPERATION KEYS

To navigate between the screens, **LogBox Wi-Fi** has 2 keys:  . Each key, depending on the current navigation screen, has two or more features:

- Short touch (less than 2 seconds):
 - Proceeds to the next screen if the current screen mnemonic is being displayed.
 - Displays the mnemonic of the current screen again if the screen information is being displayed.
- Long touch (longer than 2 seconds or held down):
 - Takes an action within the current screen.
- Both keys held down (longer than 2 seconds or held down):
 - Takes a second action within the current screen.











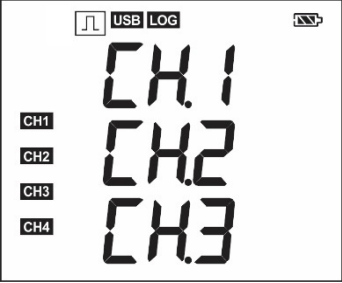
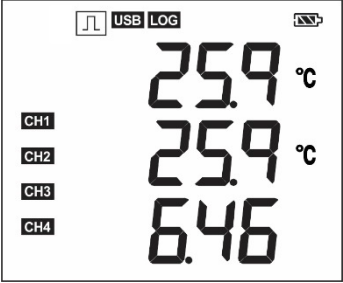

If the buzzer is active, pressing any key will mute it.

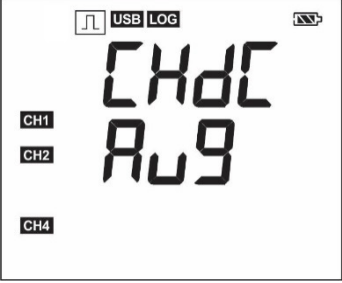
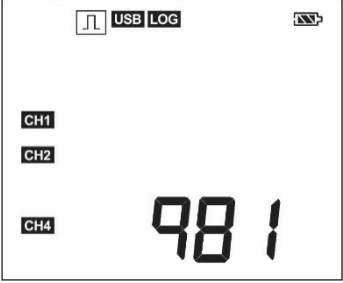



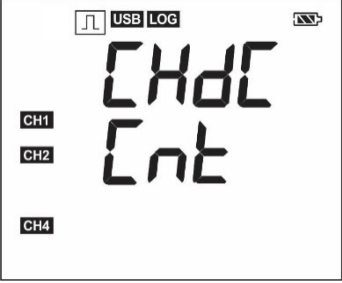
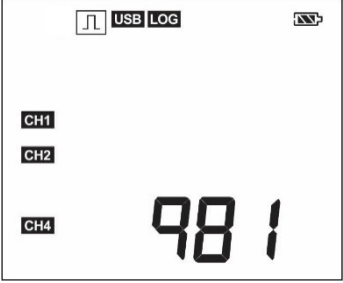





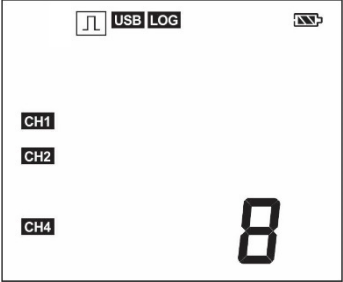

3.3 NAVIGATION SCREENS

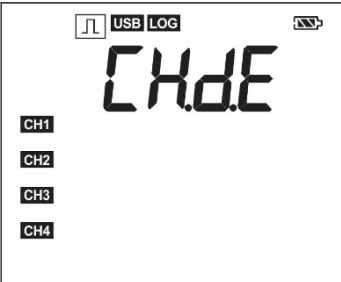
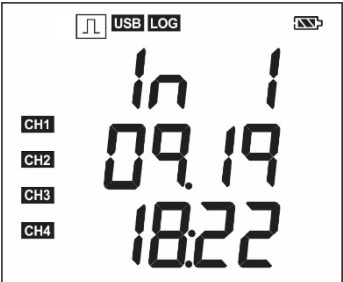



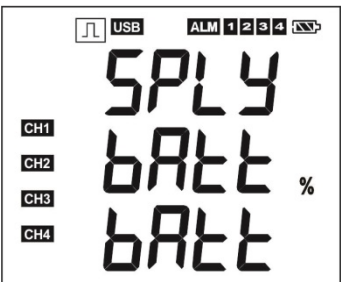
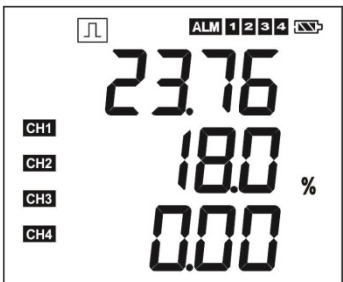





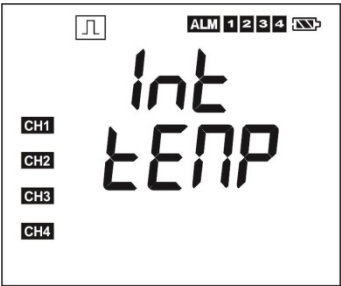
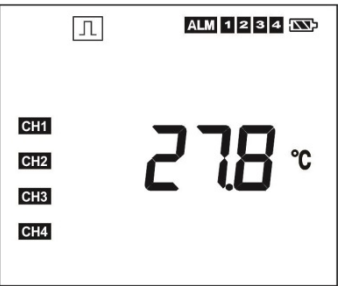

To streamline information identification on each screen, a mnemonic, which will remain visible for two seconds, will be displayed when pressing a key. If no key is pressed for this period, the information on the current screen will be displayed. If the  key or the  key is pressed while a mnemonic is being displayed, the device will advance to the next screen or return to the previous one, which will be properly specified by their mnemonics.

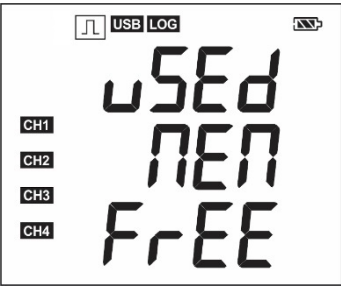
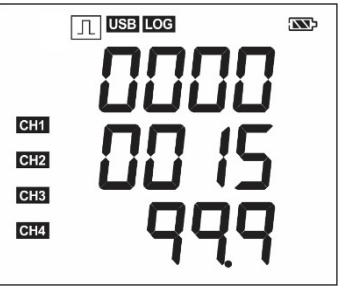



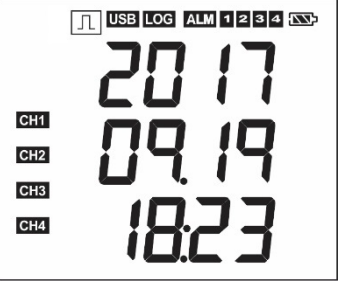





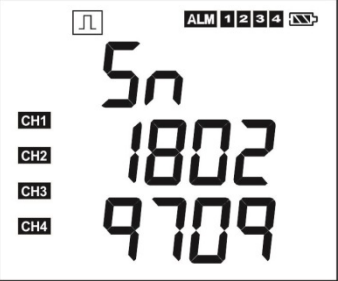

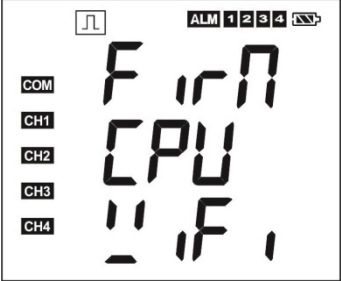
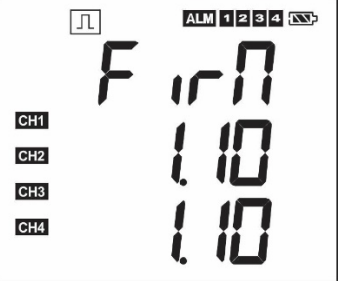

When the device is displaying the information on a screen, simply press any of the two keys to make the mnemonic appear again. To access the desired screen, just wait two seconds.



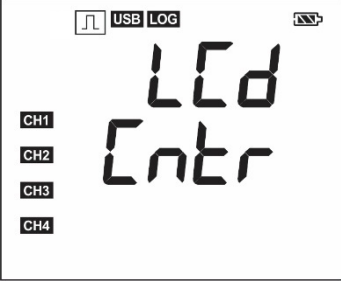







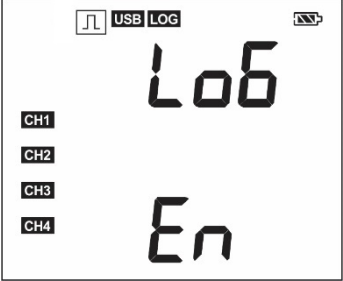

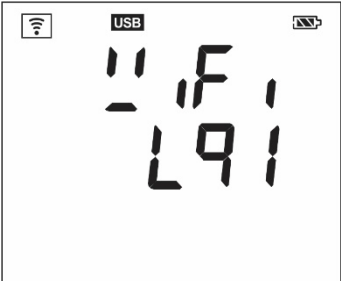

The table below shows all screens, mnemonics, and information about them, the description of each information and keys function of each screen available in the device.

SCREEN	MNEMONIC	INFORMATION	DESCRIPTION	KEYS FUNCTION
1. Analog Inputs	 <p>Displayed for 2 seconds before accessing the "Analog Inputs" screen.</p>	 <p>This screen will be updated by the log range and/or by the display update.</p>	<p>Displays the current value of the analog channels and allows the display of the maximum and minimum values reached by each channel.</p> <p>Line 1: Analog channel 1 value. Line 2: Analog channel 2 value. Line 3: Analog channel 3 value.</p>	<p> Key held down or long touch: Informs the maximum value reached in each analog channel.</p> <p> Key held down or long touch: Informs the minimum value reached in each analog channel.</p> <p>  Both keys held down: Clears the alarm statuses and the minimum and maximum values reached by each analog channel.</p>
2. Digital Input Pulse Count: Flow Rate	 <p>Displayed for 2 seconds before moving to analog inputs – Pulse Count: Flow Rate screen.</p>	 <p>This screen is updated by the display update interval.</p>	<p>When enabled and configured in "Pulse Count" mode and then configured with the "Average Flow by Acquisition Interval" option (Application parameter / Flow Rate function), it displays the average flow logged within the configured log interval. If it is not configured, this screen will not be displayed.</p> <p>Use the three lines of the display to display the logged flow rate.</p>	<p> Key held down or long touch: Informs the maximum flow rate.</p> <p> Key held down or long touch: Informs the minimum flow rate.</p> <p>  Both keys held down: Clears the minimum and maximum alarm statuses reached by each channel.</p>
3. Digital Input Pulse Count: Count	 <p>Displayed for 2 seconds before moving to digital input screen – Pulse Count: Count.</p>	 <p>This screen is updated by the display update interval.</p>	<p>When enabled and configured in the "Pulse Count" mode and then configured with "Acquisition Interval Counting" option (Application parameter / Count function), it displays the registered count within the configured registered acquisition interval. If it is not configured, this screen will not be displayed.</p> <p>Uses the three lines of the display to display the logged count.</p>	<p> Key held down or long touch: Informs the maximum flow rate.</p> <p> Key held down or long touch: Informs the minimum flow rate.</p> <p>  Both keys held down: Clears the minimum and maximum alarm statuses reached by each channel.</p>

SCREEN	MNEMONIC	INFORMATION	DESCRIPTION	KEYS FUNCTION
4. Digital Input Pulse Count: Accumulator	 <p>Displayed for 2 seconds before moving to digital input screen – Pulse Count: Accumulator.</p>	 <p>This screen is updated by the display update interval.</p>	<p>When enabled and configured in the "Pulse Count" mode and then set to "Volume since Last Reset" (Application parameter / Flow Rate function) or the option "Accumulated Count Since Last Reset" (Application parameter / Count function), displays the volume or count accumulated since the last digital channel reset. If it is not configured, this screen will not be displayed.</p> <p>Uses the three lines of the display to display the accumulated volume or count.</p>	<p> Key held down or long touch: No action.</p> <p> Key held down or long touch: No action.</p> <p>  Both keys held down: No action.</p>
5. Digital Input Event Log or Logs Control	 <p>Displayed for 2 seconds before accessing the digital input screen – Event Log or Logs Control.</p>	 <p>This screen is updated every time an event is detected in the digital input.</p>	<p>When enabled and configured in "Event Log" or "Logs Control" modes, it displays the last event detected at the digital input.</p> <p>Line 1: Edge detected in the event: 0 – Falling edge 1 – Rising edge</p> <p>Line 2: Day. Month of the event (if the 24-hour format is selected); Month. Day of the event (if the AM/PM format is selected).</p> <p>Line 3: Hour: Minute of the event.</p>	<p> Key held down or long touch: No action.</p> <p> Key held down or long touch: No action.</p> <p>  Both keys held down: No action.</p>
6. Power Status	 <p>Displayed for two seconds before accessing the "Power Status" screen.</p>	 <p>This screen will be updated with information about the device power.</p>	<p>Displays information about the device power source.</p> <p>Line 1: External source voltage.</p> <p>Line 2: Battery level.</p> <p>Line 3: Value of battery voltage.</p>	<p> Key held down or long touch: No action.</p> <p> Key held down or long touch: No action.</p> <p>  Both keys held down: No action.</p>

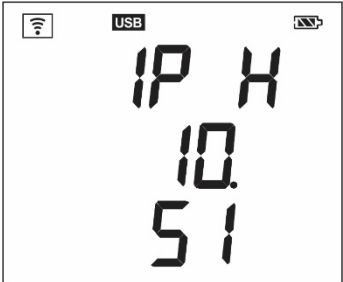
SCREEN	MNEMONIC	INFORMATION	DESCRIPTION	KEYS FUNCTION
7. Internal Temperature	 <p>Displayer for two seconds before accessing the "Internal Temperature" screen.</p>	 <p>This screen will be updated with information about the internal temperature of the device.</p>	Displays the internal temperature of the device.	 Key held down or long touch: No action.  Key held down or long touch: No action.  Both keys held down: No action.
8. Log Memory	 <p>Displayed for two seconds before accessing the "Log Memory" screen.</p>	 <p>This screen will be updated by the logs range.</p>	Displays the number of logs in the memory and free memory percentage. Line 1 and 2: Number of logs recorded in the memory. Line 3: Free memory percentage.	 Key held down or long touch: No action.  Key held down or long touch: No action.  Both keys held down: No action.
9. Date/Time	 <p>Displayed for two seconds before accessing the "Date/Time" screen.</p>	 <p>This screen will be updated by the log range and/or by the display update.</p>	Displays the device's current date and time. Line 1: Year. Line 2: Month.Day. Line 3: Hour:Minute.	 Key held down or long touch: No action.  Key held down or long touch: No action.  Both keys held down: No action.

SCREEN	MNEMONIC	INFORMATION	DESCRIPTION	KEYS FUNCTION
10. Information about Serial Number	 <p>Displayed for two seconds before accessing the "Information about Serial Number" screen.</p>	 <p>This screen is static and always has the same value for the same device.</p>	Displays the device information. Line 1 and 2: Serial number. Line 3: Firmware version.	 Key held down or long touch: No action.  Key held down or long touch: No action.   Both keys held down: No action.
11. Firmware Version	 <p>Displayed for two seconds before accessing the "Firmware Version" screen.</p>	 <p>This screen will display the device and Wi-Fi module firmware versions.</p>	Displays the device and Wi-Fi module firmware versions. Line 2: Firmware version of the device. Line 3: Wi-Fi module firmware version.	 Key held down or long touch: Increases contrast (maximum of 7).  Key held down or long touch: Decreases contrast (minimum of 0).   Both keys held down: No action.
12. Display Contrast Adjustment	 <p>Displayed for two seconds before accessing the "Display Contrast Adjustment" screen.</p>	 <p>This screen will be updated whenever the display contrast is adjusted.</p>	Displays the contrast level configured for the display and allows adjustment of the display. Line 3: Current contrast value. Can be adjusted from 0 to 7.	 Key held down or long touch: Increases contrast (maximum of 7).  Key held down or long touch: Decreases contrast (minimum of 0).   Both keys held down: No action.

SCREEN	MNEMONIC	INFORMATION	DESCRIPTION	KEYS FUNCTION
13. Log Status	 <p>Displayed for two seconds before accessing the "Log Status" screen.</p>	 <p>This screen will be updated whenever the current log status is changed.</p>	<p>Displays the current log status and allows them to be started and/or paused if the device is configured to allow keyboard start and/or end.</p> <p>En – Enabled logs. d IS – Disabled logs.</p>	 Key held down or long touch: Initiates logs if "By Keyboard" start mode is enabled.
				 Key held down or long touch: Pause records if the "By Keyboard" end mode is enabled.
				  Both keys held down: No action.
14. Wi-Fi Signal Strength	 <p>Displayed for two seconds before accessing the "Wi-Fi LQI" screen.</p>	 <p>This screen will be updated according to the Wi-Fi signal strength.</p>	<p>Displays the signal strength between the device and the Wi-Fi access point.</p>	 Key held down or long touch: No action.
				 Key held down or long touch: No action.
				  Both keys held down: No action.
15. IP High	 <p>Displayed for two seconds before accessing the "IP High" screen.</p>	 <p>This screen will be updated whenever the IP is changed.</p>	<p>Displays the first two octets of the configured IP address.</p>	 Key held down or long touch: No action.
				 Key held down or long touch: No action.
				  Both keys held down: No action.







SCREEN	MNEMONIC	INFORMATION	DESCRIPTION	KEYS FUNCTION
16. IP Low	 <p data-bbox="407 488 808 539">Displayed for two seconds before accessing the "IP Low" screen.</p>	 <p data-bbox="833 488 1234 539">This screen will be updated whenever the IP is changed.</p>	Displays the last two octets of the configured IP address.	 Key held down or long touch: No action.
	 Key held down or long touch: No action.			
	  Both keys held down: No action.			

Table 1 – Navigation Keys

4. OPERATION AUTONOMY

LogBox Wi-Fi is powered by an external power supply, with a 10 to 30 VDC input, or USB port. The device can optionally be powered by four standard "AA" batteries (1.5 V each) which, in the event of a power failure in the power supply source, will keep it running for at least two years. In this case, to reduce consumption, the Wi-Fi interface will be disabled. All other features, however, will remain in operation for at least one year. When power from the power supply source is restored, the Wi-Fi interface will be activated, and the data logged in memory during the power interruption will be published in the services that support backup.

While the device is operated by batteries, very high temperatures (above 30 °C) or too low (below 10 °C) will cause battery chemistry to react outside typical operating characteristics, reducing battery life. Thus, when operating the device in these ranges, consider that the two-year expectation can be reduced considerably.

While the device is operating on batteries, temperatures too high (above 30 °C) or too low (below 10 °C) will make the **LogBox Wi-Fi** circuit greatly increase its consumption. Thus, when operating the device in these ranges, consider that the two-year expectation can be reduced considerably.

Some scenarios can also increase **LogBox Wi-Fi** consumption, considerably reducing battery life expectancy. Here are some examples of situations that may decrease battery life:

- **Alarm:** Alarm occurrences more than once a day and with a buzzer duration over 30 seconds.
- **Event Log:** Events that occur with a frequency greater than once every hour.

When necessary, the batteries can be replaced with any model that has characteristics like alkaline batteries (1.5 V). However, replacement with *Energizer E91* units (identical to those accompanying the device) or *Energizer L91* (which has a higher operating temperature range) is recommended to ensure the expected battery life expectancy and specified working temperature. If you choose another battery model, it is necessary to check its working temperature and life expectancy.



Never mix batteries of different models, or new batteries with used ones. Whenever you are replacing the batteries, replace all of them at the same time.

Check battery polarity before inserting it into the device. Never use an inverted battery.

While the LogBox Wi-Fi is powered by batteries, and to reduce power consumption, the Wi-Fi interface will remain disabled.

5. INPUT SIGNALS READING

LogBox Wi-Fi allows users to choose, in addition to the channels to be registered and sensor types, some configurations that provides flexibility to several applications, offering the possibility of weighing the energy resources (battery life) and data storage (length of log memory). Thus, it is possible to configure the device with the following parameters:

- **Log Range:** Shows frequency, in seconds, with which an acquisition must be made and logged in the memory. A low periodicity will increase battery consumption and fill up the memory faster.
 - **Minimum Range:**
 - 1 second (if no channel is configured to operate on average)
 - 10 seconds (if a channel is configured to operate on average)
 - **Maximum Range:** 18 hours.
- **Display Update Range:** Shows frequency, in seconds, with which an acquisition must be made and updated on the display. It allows you to save memory by configuring it to a larger range of logs without damaging the Display update rate. Low frequency increases battery consumption. This range can be disabled if set to '0'. Thus, the display update will take place in the log range.
 - **Minimum Range:** 1 second
 - **Maximum Range:** 1 hour

When configuring a Display Update Range, it should be less than the Log Range. Otherwise, it will be ignored, and the display will be updated at the same Log Range.

The Display Update Range only updates Analog Channels that are not configured to operate on average. Thus, the Digital Channel that is configured to operate in counting mode and the Analog Channels that are configured to operate on average will only have their information updated at each log range.

If the digital channel is operating in the "Event Log" mode, each event will update its respective information on the display.

5.1 ANALOG INPUTS

LogBox Wi-Fi has three channels for reading analog signals. The types of signals and sensors accepted by them are:

- **Temperature Sensors:**
 - Thermoresistance Pt100
 - Thermocouples J, K, T, N, E, R, S, and B
 - Internal Temperature Sensor
- **Linear Sensors:**
 - 0 to 50 mV
 - 0 to 5 V
 - 0 to 10 V
 - 0 to 20 mA
 - 4 to 20 mA
- **Internal Diagnostic Sensors:**
 - Battery Voltage
 - External Power Supply Voltage

Each type has specific operation configurations and characteristics. Its configurations and characteristics are described below:

- **Temperature Sensors:**
 - Inform the measured temperature within the possible measuring range of each sensor.
 - The maximum resolution for the Temperature Sensors is 0.1 °C.
 - You can configure them to be displayed with one or no decimal places.
 - You can configure them to be displayed in units of measure °C or °F.
- **Linear Sensors:**
 - Inform you of some magnitude in the range required by the user (defined in the parameter "User Range"), as configured in the "Lower Limit", "Upper Limit", and "Number of Decimal Places" parameters.
 - **Number of Decimal Places:** Allows you to choose to use 0, 1, or 2 decimal places.
 - **Lower Limit:** Corresponds to the value configured to represent the minimum value of the chosen sensor:
 - Minimum -19999 to 0 decimal places
 - Minimum -1999.9 to 1 decimal place
 - Minimum -199.99 to 2 decimal places
 - **Upper Limit:** Corresponds to the value configured to represent the maximum value of the chosen sensor:
 - Maximum 19999 to 0 decimal places
 - Maximum 1999.9 to 1 decimal place
 - Maximum 199.99 to 2 decimal places

- You can configure them to be displayed in units of measurement °C, °F or in a custom unit of up to 8 characters, which will not show on the display.
- The maximum resolution for linear sensors corresponds to a ratio between the user range and the maximum resolution of the chosen sensor.
- **Internal Diagnostic Sensors:**
 - Inform the voltage of the possible **LogBox Wi-Fi** power supply sources.
 - The maximum resolution for the internal diagnostic sensors is 0.01 V.
 - You can configure them to be displayed with 0, 1, or 2 decimal places.
 - The unit of measure for these sensors is Volts and no unit symbol is displayed.

Refer to the [Technical Specifications](#) chapter to check these signals' accuracy. Refer to the [Installation](#) chapter to check these signals' connection.

An analog/digital (A/D) converter with high resolution and accuracy is used to read the sensors connected to the analog channel inputs. In the desired scan range, all the analog channels enabled will be read.

Each type of input signal has a valid measuring range (see the chapter [Technical Specifications](#)). However, the device can typically measure signals which slightly exceed the limits of this range. The amount it can measure beyond it, however, depends on the type of input configured and can vary between different devices.

The following table describes the input types supported by the device, the device's signal conditions and their respective indications.

5.1.1 MEASUREMENT AND INDICATION OF INPUT TYPES

INPUT TYPE	INPUT SIGNAL CONDITION	INDICATION
Pt100	Within range	Read input value
	Pt100 with one or more wires disconnected	---- will be displayed -22000 will be logged in the memory
	Slightly above the upper limit	Read input value *
	Slightly below the lower limit	Read input value *
	Far above the upper limit	UUUU will be displayed 32767 will be logged in the memory
	Far below the lower limit	nnnn will be displayed -32000 will be logged in the memory
Thermocouples J, K, T, E, N, R, S and B	Within range	Read input value
	Open Thermocouple	---- will be displayed -22000 will be logged in the memory
	Slightly above the upper limit	Read input value *
	Slightly below the lower limit	Read input value *
	Far above the upper limit	UUUU will be displayed 32767 will be logged in the memory
	Far below the upper limit	nnnn will be displayed -32000 will be logged in the memory
Voltage 0 to 50 mV	Within range	Read input value converted into User
	Signal disconnected	---- will be displayed -22000 will be logged in the memory
	Slightly above the upper limit	Read input value converted into User Range *
	Slightly below the lower limit	Read input value converted into User Range *
	Far above the upper limit	UUUU will be displayed 32767 will be logged in the memory
	Far below the lower limit	nnnn will be displayed -32000 will be logged in the memory
Voltage 0 to 5 V 0 to 10 V	Within range	Read input value
	Signal disconnected	0 V converted into User Range
	Slightly above the upper limit	Read input value converted into User Range *
	Slightly below the lower limit	Read input value converted into User Range *
	Far above the upper limit	UUUU will be displayed 32767 will be logged in the memory

INPUT TYPE	INPUT SIGNAL CONDITION	INDICATION	
	Far below the lower limit	<p>■■■■ will be displayed -32000 will be logged in the memory</p>	
<p>Current 0 to 20 mA 4 to 20 mA</p>	Within range	Read input value converted into User Range	
	Signal disconnected	0 a 20 mA	0 mA converted into User Range
		4 a 20 mA	<p>---- will be displayed -22000 will be logged in the memory</p>
	Slightly above the upper limit	Read input value converted into User Range *	
	Slightly below the lower limit	0 a 20 mA	It is not possible to decrease more than the lower limit
		4 a 20 mA	Read input value converted into User Range *
	Far above the upper limit	<p>UUUU will be displayed 32767 will be logged in the memory</p>	
	Far below the lower limit	0 a 20 mA	It is not possible to decrease more than the lower limit
4 a 20 mA		<p>■■■■ will be displayed -32000 will be logged in the memory</p>	

(*) **Note:** The analog channel indication continues slightly beyond the limits specified for the selected input type. However, in this condition, accuracy is not guaranteed.

Table 2 – Measurement and indication of input types by LogBox Wi-Fi

LogBox Wi-Fi allows you to configure settings to be applied to analog sensor readings. These settings can be used to correct errors in the sensor or process in which the sensor is installed and applied individually for each analog channel. Two adjustment modes are provided by the device:

- **Offset:** Allows each analog channel to choose an Offset value to be added to the channel reading indication. It is a simple and fast feature to adjust the display throughout the range.
- **Custom Calibration:** Allows you to enter up to 10 set points for each channel to correct distortions in reading these channels at these points. We call this characteristic a "custom calibration" because it allows the user to adjust the indication at the desired points by zeroing their errors. The adjustment is made linearly between the points entered, according to the values entered.

It is important to note that both the Offset adjustment and the insertion of custom calibration points are optional, only indicated for those who wish to adjust the indication to a local standard, since the **LogBox Wi-Fi** has already been calibrated at the factory.

	Whenever you change the input type, make sure that the custom calibration points of the previous input are deleted!
---	--

For each analog channel, a unique (Tag) name must be assigned, which will be used to reference the channel. You should also choose the type of input (sensor) that will be connected to that channel. In addition to that, you can assign the unit of measured value: for temperature sensors (Pt100 or thermocouples), degrees Celsius (°C) or Fahrenheit (°F); for linear sensors (current or voltage), you can enter the desired unit.

In the case of linear input types, one must choose the sensor indication range, that is, what the channel should indicate when the input is at its minimum value and what it should indicate when it is at its maximum value (minimum and maximum values considering the **LogBox Wi-Fi** working range for the chosen input type). Once the 4 to 20 mA input type is chosen, for example, a pressure transmitter from 0 to 2 bars will be connected. In this case, "0.0" must be chosen as the minimum value and "2.0" as the maximum value in the input configuration. All resolution and accuracy available will be contained within the chosen range.

When a simulator is used on analog inputs that are connected to the mains (e.g. a thermocouple or voltage simulator) and it is not isolated, it is recommended to use a different reading interface than USB. In some cases, the occurrence of noise and read Offsets has already been detected due to the influence of the USB cable connection, probably by ground loops.

LogBox Wi-Fi, when operated by batteries, keeps the entire analog circuit switched off while no acquisition is being made. This strategy is necessary so that it can operate for more than two years without needing to change batteries. This characteristic may cause some undesirable effects during calibration, as some analog signal simulators (e.g., thermocouples simulator or a Pt100) may not operate properly, causing false reading Offsets and oscillations. Should such a problem be identified, it is recommended to power the **LogBox Wi-Fi** by external source or USB cable while using a simulator.

Setting the local network frequency (50 Hz or 60 Hz) is important as it helps improve the performance of reading analog channels even while the device is running on battery power. Usually, the power grid causes interference in the signal read from the sensors, which can be more easily mitigated if we know the frequency.

5.2 DIGITAL INPUT

LogBox Wi-Fi has a Digital Input channel that can be configured for "Pulse Count", "Event Log", or even for "Logs Control" modes. This Digital Input can be disabled.

Regardless of the function for which it will be used, you must configure the type of sensor output that will be connected to the input: PNP, NPN, or Dry Contact (refer to chapter [Installation](#) to see how the sensors should be connected). In addition to that, it is necessary to select the edge of interest of the digital signal to generate the count, event, or start/end of logs: rising edge, falling edge, or both edges.

Relationship between Sensor Type, Sensor Status, and Logical Level obtained in LogBox Wi-Fi		
Sensor Type	Sensor State	Logical Level
PNP	Open	0
	Closed	1
NPN	Open	1
	Closed	0
Dry Contact	Open	1
	Closed	0

Table 3 – Digital Input

For Dry Contact sensors, it is necessary to set a *debounce* time of at least 50 ms (sensor stabilization time / time in which the sensor must remain in the state of interest for it to be considered valid). For PNP or NPN type sensors, if configured in "Pulse Count" mode, it is not necessary to set a *debounce* time. However, if the digital input is configured for the "Event Log" or "Logs Control" modes, a minimum *debounce* of 50 ms is required to prevent any noise from generating a false event. In the "Event Log" and "Logs Control" modes, events will be generated after the end of the *debounce* time.

5.2.1 PULSE COUNT

When setting the digital input in "Pulse Count" mode, you can select an application mode: "Flow Rate" or "Count".

The "Flow Rate" mode allows, if "Average Flow by Acquisition Interval" is selected, to log the average flow rate or, if "Volume Since Last Reset" is selected, to count the total volume within a previously configured period until the count is reset.

The "Count" mode, in turn, allows, if the "Acquisition Interval Counting" option is selected, to count the number of pulses that occurred within the Log Interval or, if the "Accumulated Count Since Last Reset", to count the total number of pulses logged within a preset period until the count is reset.

LogBox Wi-Fi has a 32-bit register, responsible for accumulating the volume or number of pulses within a certain configurable reset interval. For example, you can set the device to reset monthly or on a specific day and time (See [Accumulator Resetting Modes](#) section of the [Configuration Software](#) chapter).

LogBox Wi-Fi also has a 16-bit register, responsible for measuring the average flow rate per acquisition interval or for performing the count per acquisition interval. At each log interval, **LogBox Wi-Fi** counts the number of pulses that have occurred and registers it in memory, resetting the register so that it can accumulate the pulses of the next interval.

If the sensor is a Dry Contact type, the **LogBox Wi-Fi** count registers (16 bits and 32 bits) will be able to count up to 10 pulses per second. For PNP and NPN sensors, 2000 pulses per second. However, in the case of the 16-bit register, it is important to note that these pulses will accumulate within each logging interval. Thus, if the "Average Flow Through Acquisition Interval" or "Acquisition Interval Count" modes are selected, it is necessary to evaluate the maximum sensor frequency so that it does not exceed 65535 counts (16 bits) within the logging interval, causing an overflow in the logger that accumulates them.

If the maximum sensor frequency is 2 kHz, **LogBox Wi-Fi** will accumulate 2000 pulses per second for up to 32 seconds. Upon exceeding this interval, the number of accumulated pulses will exceed 65535 counts, resulting in overflow in the 16-bit register. For a sensor that can reach 2000 pulses per second, the recommended log frequency should be less than 32 seconds.

When the option "Volume since last reset" or the option "Accumulated count since last reset" is selected, the number of counts is, in turn, limited by the 32-bit accumulator register and, thus, enables the counting of a limit number of 4294967295 pulses. Thus, the periodicity of the reset must also be adjusted according to the frequency of the sensor pulses. By keeping the same example of sensor use at maximum frequency, i.e. 2 kHz, it is recommended that the periodicity be less than 24 days, otherwise an overflow will be generated in the register.

In typical applications, such as flow and volume measurement, simple pulse counting is not enough, being necessary to convert these pulses into a flow unit. For this, one can select the desired flow unit and a conversion factor which will transform the number of pulses generated by the connected transmitter in flow information. The pulse conversion logged in the range for the flow unit configured by the user will occur every time the logged data is displayed.

To streamline the digital channel configuration in "Pulse Count" mode and the conversion to flow in the unit required, **LogBox Wi-Fi** provides the following units of measure:

Flow Units	Sensor Units
l/s, l/min, l/h, gal/s, gal/min, gal/h, m³/s, m³/min, m³/h.	pulses/l, pulses/gal, pulses/m³.

Table 4 – Measure Units

If you use one of these flow and sensor units, you only need to inform the "Sensor Factor" parameter. If none of the units available is required, you need to calculate the "User Factor", relating it to the "User Unit" parameter, and fill in the parameter so that **LogBox Wi-Fi** can correctly convert the pulses to the unit required. In this case, **LogBox Wi-Fi** will convert the pulses to the user unit as follows:

- $User\ Value = ((Count) / (Sensor\ Factor)) * (Unit\ Factor)$
 - It is not necessary to consider the log interval for calculations.

Figure 2 – Digital Input

If the user wants to visualize the production of pieces in "pieces per minute", for example, and the application has a sensor of the type PNP that, every 30 pulses in the rising edge, computes the produced piece, the following parameters must be configured on the digital input of the device:

- **Input Type:** Pulse Count.
- **Sensor Type:** PNP.
- **Counting Edge:** Rising.
- **Application:** Flow Rate.
- **Sensor Factor:** 30 (pulses/piece).

It is necessary to select the "Average Flow by Acquisition Interval" option and, after that, fill in the following parameters:

- **Unit:** Custom.
- **Unit Factor:** 60 (conversion of pieces per second to pieces per minute).

It is also possible to select the "Volume Since Last Reset" option and, after that, fill in the following parameters:

- **Unit:** Custom.
- **User Factor:** 1 (storage the accumulated number of pieces).

Thus, **LogBox Wi-Fi** will log, in each log interval, the number of pulses occurring within that period, and every time the data is displayed, it will turn those pulses into the number of pieces produced per minute (custom unit of the user).

In the same example, let us say that the log interval is 20 seconds. Thus, if the sensor gives 20 pulses per second, the **LogBox Wi-Fi** will register 400 pulses per range, displaying to the user 40 pieces per minute $((20\ pulses/s)/(30\ pulses/piece)) * 60\ (1\ min) = 40$.

5.2.2 EVENT LOG

If the digital input is configured in the "Event Log" mode, each selected edge will create a log in memory, informing the event and the instant that it occurred. This log will not be synchronized with the periodic logs but will respect the logs beginning and end modes. Events will be logged after the end of the *debounce* time set and will be logged with the *debounce* time delay. **LogBox Wi-Fi** can log up to 10 events within 1 second.

5.2.3 LOGS CONTROL

It is possible to use the digital input to start and/or pause the logs of the other input channels. Once configured in the "Logs Control" mode, each selected edge will start or stop the process of in-memory logs. As in the "Event Log" mode, detected events will only act after the configured *debounce* time expires. Thus, the start/pause of the logs will be performed with the *debounce* time delay.

6. DIGITAL OUTPUT

The **LogBox Wi-Fi** has a PNP-type Digital Output which when triggered places the voltage from the external power supply to the respective terminal and can be disabled or configured to operate in one of the modes described below:

- **Auxiliary Electronic Switch:** Allows you to control the power supply of external instruments during analog channel readings. 4-20 mA transmitters, for example, can be fed by the digital output pin, so that they are only turned on when they are read – which would save energy from the **LogBox Wi-Fi** external power supply, which can be a 12 V battery. In the "Auxiliary Electronic Switch" mode, it will be necessary to configure how long before each acquisition the digital output must be triggered.
 - **Drive Time:** It defines, in seconds, how long before each acquisition the digital output must be triggered. It will be deactivated when the acquisition is ready. Such time cannot be longer than the lowest acquisition range (Instant, Average = 1/10 of the snapshot, Interval of Display Range). If equal to 0, the Auxiliary Electronic Switch will be enabled at the exact moment of an acquisition. If greater than or equal to the lowest acquisition range, the Auxiliary Electronic Switch will remain be enabled.
- **Alarm Status:** Allows you to follow the current general alarm status. If any channel is in an alarm situation, the Digital Output will be triggered. If no channel is set to alarm, the Digital Output will be disabled.

7. COMMUNICATION WITH NOVUS CLOUD

NOVUS Cloud (check the complete manual on our website) is a portal in the cloud that makes it possible to manage the data registered in the device. With the help of **NXperience**, software that allows local configuration and data management and offers graphical analysis, reporting functionality and export to various formats, it is possible to create a free account in **NOVUS Cloud**.

When configured to send data to the **NOVUS Cloud**, **LogBox Wi-Fi** will immediately start sending data to the platform. To use the **NOVUS Cloud**, it is necessary to create an account on the platform and register the configured device. It is possible to create a **NOVUS Cloud** account through **NXperience** software or through the **NOVUS Cloud** account creation page.

NXperience allows downloading data through the **NOVUS Cloud**. The data download process will search the data already published on **NOVUS Cloud**.

The MQTT protocol and **NOVUS Cloud** functionality do not work simultaneously.

For more information on registering accounts and devices to **NOVUS Cloud**, check the **NXperience** or the **NOVUS Cloud** manual, available on our website.

8. MQTT PROTOCOL

LogBox Wi-Fi is compatible with the Message Queue Telemetry Transport (MQTT) protocol, a protocol designer for low data bandwidth consumption and which uses the Publish/Subscribe paradigm for message exchange.

Acting as a Publisher/Subscriber MQTT, **LogBox Wi-Fi** requires a middleware named Broker, responsible for sending messages from Publishers to Subscribers, to operate. **LogBox Wi-Fi** is, simultaneously, a Publisher, with 7 publication topics, to provide information about sensors and several device statuses and a Subscriber, with 1 inscription topic, to receive possible parameters alterations and to remotely offer a certain control level to the user.

If configured, this protocol also allows the **LogBox Wi-Fi** to communicate with Amazon Web Services (AWS). To perform this procedure, check the **AWS via MQTT Configuration Manual**, available on our website.

The MQTT protocol and **NOVUS Cloud** functionality do not work simultaneously.

8.1 PUBLICATION TOPICS

When connected to a Broker, the **LogBox Wi-Fi** can register up to seven topics, which will be presented below. Check the [Frame Parameters](#) section of this chapter for more information about the frames that molded the responses to each publication topic.

The message sent in each topic corresponds to a JSON frame, which encapsulates several parameters. In the frame, these parameters correspond to strings. Values of each parameter, however, must be processed differently.

8.1.1 STATUS TOPICS

- **novus/<sn>*/status/channels**: Topic for the publication of the **last** log of the analog channels and digital channel in "Pulse Count" mode.
Example: {"n_channels":4,"n_alarms":10,"timestamp":43277.69538194,"battery":5.69,"value_channels":[0.000,24.200,0.000,24.200], "alarms":[1,1,0,0,1,0,0,0,0,0], "buzzer_state":0}
- **novus/<sn>*/status/event**: Topic for the publication of the **last** log of the digital channel in "Event Log" mode.
Example: {"timestamp":43277.82236111, "event_type":"down", "millisecond":630}
- **novus/* /status/event/accumulator**: Topic intended for the publication of the **last** log of the accumulator channel (Volume/Count since the last Reset) before the counter is reset. In case of overflow, it will be published with the following value: 4294967296.
Example: {"timestamp":44092.78295139, "ch_dig_acc":4294967296}

8.1.2 LOGS TOPICS

- **novus/<sn>*/log/channels**: Topic for the publication of **all** logs of the analog channels and digital channel in "Pulse Count" mode. Used mainly when there is loss of communication link with the Broker or lack of external power, as it will receive all historical logs.
Example: {"n_channels":4, "n_alarms":10, "timestamp":43277.69538194, "battery":5.69, "value_channels":[0.000,24.200,0.000,24.200], "alarms":[1,1,0,0,1,0,0,0,0,0], "buzzer_state":0}
- **novus/<sn>*/log/event**: Topic for the publication of **all** logs of the analog channels and digital channel in "Event Log" mode. Used mainly when there is loss of communication link with the Broker or lack of external power, as it will receive all historical logs.
Example: {"timestamp":43277.82236111, "event_type":"down", "millisecond":630}
- **novus/* /log/event/accumulator**: Topic for the publication of **all** logs from the accumulator channel (Volume/Count since the last Reset) before the counter is reset. In case of overflow, it will be published with the following value: 4294967296. Used mainly when there is a link break or external power failure, as it will receive all the historical logs.
Example: {"timestamp":44092.78295139, "ch_dig_acc":4294967296}

8.1.3 CONFIGURATION TOPIC

- **novus/<sn>*/config**: Topic for the publication of the device configuration. It shall be published at the latest every five minutes.
Example: {"n_channels":4,"n_alarms":10, "timestamp":43277.56898148, "frame_format":"array_static", "channels_enabled":[0,1,0,1], "hash":"C071DA88ABA151A607AAB1527000E0017335FF08", "gmt":-180, "tag_channels":["","Analog1","","Analog3"], "tag_units":["","Celsius","","Celsius"], "sp_alarms":[0.000,0.000,0.000,20.000,25.200,0.000,0.000,0.000,0.000,0.000]}

8.1.4 RESPONSE TOPIC

- **novus/<sn>*/response**: Topic for the publication of the command's response received by the device. **Table 06** lists the permissible error responses for this topic.
Example: {"config_receive":"ok", "error_type":"none", "parameter":"none"}

8.1.5 IDENTIFICATION TOPIC

- **novus/neighbor**: Topic for the publication of the identify from the device(s) connected to the Broker. It shall be published at the latest every five minutes.
Example: {"model":"LogBox Wi-Fi", "serial":12345678, "ip":"192.168.88.10", "mac":"B0:38:29:5D:FE:B1", "lqi":-40, "firmware_version":1.00}

* The <sn> is the device serial number. That way, there will be no clash of topics in the Broker.

8.2 INSCRIPTION TOPIC

When connected to a Broker, **LogBox Wi-Fi** can receive commands that will be answered through the `novus/<sn>*/response` topic, as can be seen below.



Commands in this topic can only be sent to the Broker if they have written permission enabled in the **NXperience** software (see [MQTT Protocol](#) section of the [Configuration Software](#) chapter).

- `novus/<sn>*/command`: Topic for receiving commands sent via MQTT.
Example: `{"buzzer_state":0}`

Command	Type	Example	Description
sp_alarm_01	Double	<code>{"sp_alarm_01":125.37}</code>	Allows you to change the alarm channel 1 setpoint.
sp_alarm_02	Double	<code>{"sp_alarm_02":50.37}</code>	Allows you to change the alarm channel 2 setpoint.
sp_alarm_03	Double	<code>{"sp_alarm_03":50.37}</code>	Allows you to change the alarm channel 3 setpoint.
sp_alarm_04	Double	<code>{"sp_alarm_04":50.37}</code>	Allows you to change the alarm channel 4 setpoint.
sp_alarm_05	Double	<code>{"sp_alarm_05":50.37}</code>	Allows you to change the alarm channel 5 setpoint.
sp_alarm_06	Double	<code>{"sp_alarm_06":50.37}</code>	Allows you to change the alarm channel 6 setpoint.
sp_alarm_07	Double	<code>{"sp_alarm_07":50.37}</code>	Allows you to change the alarm channel 7 setpoint.
sp_alarm_08	Double	<code>{"sp_alarm_08":50.37}</code>	Allows you to change the alarm channel 8 setpoint.
sp_alarm_09	Double	<code>{"sp_alarm_09":50.37}</code>	Allows you to change the alarm channel 9 setpoint.
sp_alarm_10	Double	<code>{"sp_alarm_10":67.35}</code>	Allows you to change the alarm channel 10 setpoint.
buzzer_state	Boolean	<code>{"buzzer_state":1}</code>	It informs the current state of the buzzer, according to the parameter established in the Boolean settings of the sent command. For this command to work, it is necessary that the Buzzer option of the MQTT tab of the NXperience has been selected. See the Boolean Format section of this chapter for more information about Boolean types and formats.
internal_clock	Unix Timestamp or TDateTime	<code>{"internal_clock":1533294048}</code> If Unix format <code>{"internal_clock":43277.40465278}</code> If TDateTime format	Displays the device's internal clock. This parameter must be written with the same Timestamp format defined in NXperience . For this command to work, it is necessary that the Intern Clock option of the MQTT tab of the NXperience has been selected. See the Timestamp section of this chapter for more information on the formats supported by the device.
set_download	Unix Timestamp or TDateTime	<code>{"set_download":1533294048}</code> If Unix format <code>{"set_download":43277.40465278}</code> If TDateTime format	Command used to request that LogBox Wi-Fi resend all logs from the requested date in the <code>/log/channels</code> and <code>/log/event</code> topics (see Logs Topics section of this chapter). For this command to work, it is necessary that the Set Download option of the MQTT tab of the NXperience has been selected. This parameter must be written with the same Timestamp format defined in NXperience . See the Timestamp section of this chapter for more information on the formats supported by the device.
accumulator_reset	Boolean	<code>{"accumulator_reset":1}</code>	Command used to reset the 32-bit accumulator count if configured to allow reset via MQTT. The only values allowed are 1 and true , according to the parameter established in the Boolean settings of the command sent. For this command to work, it is necessary to select the option Via MQTT on the tab Accumulator Resetting Modes . See Boolean Format section of this chapter for more information on Boolean types and formats.

Table 5 – Command list

If successful, the device will send a message that can be viewed in the response topic `novus/<sn>*/response`, as described in the [Response Topic](#) section of this chapter.

If there is any kind of error during the command request, the device will still send a response via the `novus/<sn>*/response` topic, but it will inform the type of error found, as described in [Table 6](#).

Example:

Command: `{"buzzer_state":0}`

Answer: `{"config_receive":"fail","error_type":"NOT_AUTHORIZED_ERROR","parameter":"buzzer_state"}`

* The `<sn>` is the device serial number. That way, there will be no clash of topics in the Broker.

Error Type	Description
NOT_AUTHORIZED_ERROR	Unauthorized parameter for writing.
INVALID_VALUE_ERROR	Error for values outside parameter range.
ALARM_DISABLED_ERROR	Error resulting from attempting to change the setpoint of an alarm disabled.
CHANNEL_DISABLED_ERROR	Error resulting from attempting to change the alarm setpoint of a disabled channel.
EVENT_CHANNEL_ERROR	Error resulting from attempting to change the setpoint on the digital channel when it is set to "Event Log".
INVALID_STRING_ERROR	Error resulting from attempting to place an invalid key in the parameter.
PARSE_ERROR	Error in the JSON frame parse.

Table 6 – Error type

8.3 FRAME PARAMETERS

The following is a list of permissible parameters within each frame:

PARAMETER	DESCRIPTION
alarms	Informs which channels are in the alarm. See the Boolean Format section of this chapter for more information on how Boolean variables work.
battery	Informs the current voltage of the battery in volts and with two decimal places.
buzzer_state	Informs whether the buzzer is in alarm. See the Boolean Format section of this chapter for more information on how Boolean variables work.
channels_enabled	Reports the number of active channels on the device. If it is active or configured as static, the digital channel in "Pulse Count" mode will always be the first item in the array. The array order of the channels is: Digital channel, analog channel 1, analog channel 2 and analog channel 3. See the Boolean Format section of this chapter for more information on how Boolean variables work.
config_received	Informs if the configuration was successfully sent or if there was an error during the process.
event_type	Informs the event counting edge: Rising edge, Falling edge, or both edges. Permissible only for the digital channel and configurable through the NXperience software (see the chapter Configuration Software).
error_type	Reports the type of error encountered during the attempt to execute the command. See Table 06 in this chapter for more information on error types.
firmware_version	Informs the firmware version of the device.
frame_format	Informs the type of JSON format defined for the frame. See the JSON Format section from the chapter for more information on frame formats.
gmt	Informs GMT in minutes.
hash	Informs the generated key by setting or changing any device parameters. It acts as a kind of configuration password applied to the device and is widely used in validated systems.
ip	Informs the IP device.
lqi	Informs the quality of the Wi-Fi connection.
mac	Informs the MAC address of the device.
model	Informs the device model.
millisecond	Informs in how many milliseconds the log event happened. You can supplement the timestamp parameter.
n_channels	Informs the numbers of the device channels.
parameter	Informs the parameter in which was change according to the sent topic.
serial	Informs the device serial number.
sp_alarm	Informs the alarm setpoint.
tag_channels	Informs the defined tag for each channel through NXperience software. See the Configuration Software chapter for more information on how to set the tag for each channel.
tag_units	Informs the unit tag defined for each channel using the NXperience software: Celsius (°C) or Fahrenheit (°F). See the Configuration Software chapter for more information about the drives supported by the device.
timestamp	Informs the log date and time in Unix Timestamp or TDateTime format, as defined in the MQTT tab of NXperience software. See the Timestamp section of this chapter for more information on both formats or the MQTT Protocol section of the Configuration Software chapter to find out how to set up the Timestamp.

PARAMETER	DESCRIPTION
value_channels	Informs the values read by the active channels, always using three decimal places to do it.

Table 7 – Frame Parameters

8.3.1 TIMESTAMP

The frame timestamp parameter informs the timestamp of the device in UNIX Timestamp or TDateTime format, as configured in the **NXperience Time Format** parameter (check the [MQTT Protocol](#) section of the [Configuration Software](#) chapter).

In an example where the date and time of a log are 18/07/2018 and 20:25:58, respectively, the MQTT protocol would convert them to:

- **UNIX Timestamp:** 1531945548.
- **TDateTime:** 43299.8512615.

8.4 MQTT PROTOCOL CONFIGURATION IN SOFTWARE NXPERIENCE

The user can enable and configure the MQTT protocol through the **NXperience** software, as can be seen in the [Configuration Software](#) chapter. Below are pertinent information and concepts about the MQTT protocol and that will later be essential for its configuration in **NXperience**.

8.4.1 QoS

The Quality of Service (QoS) serves to indicate the quality of the service in relation to the delivery of the data packets.

QoS	Delivery Type
0	At most once. Known as "best effort". It resembles the UDP transport protocol, where there are no acknowledgments of message delivery to the sender. The sender has no obligation to keep the message stored for future retransmissions.
1	At least once. There is a message confirmation of delivery. It addresses situations where the sender of the message ends up generating several identical messages, possibly due to a delay in the arrival of the confirmation of receipt. This type of delivery ensures that at least one of them can perform the recognition. The message will be stored by the sender until there is a further confirmation of receipt from the recipient.
2	Exactly once. It ensures that the message is delivered exactly once, also guaranteeing the sending of confirmations of receipt and confirmations of receipt of the own confirmations of receipt. There are confirmations in two directions for everything that is trafficked. If a message is not acknowledged by the recipient, it is maintained by the sender.

Table 8 – QoS

8.4.2 JSON FORMAT

The **NXperience JSON Format** parameter allows you to change the formatting of the JSON frame as required by the supervisory software, as shown in the examples below, which propose a situation where analog channels 1 and 3 are enabled.

- **Static Array:** Send information about all variables, even those that are not enabled, grouping each parameter inside brackets.
 - **Status:**

```
{
  "n_channels":4,"n_alarms":10,"timestamp":43277.40465278,"battery":5.69,"value_channels":[0.000,22.300,0.000,22.300],"alarms":[0,1,0,0,0,0,0,0,0,0],"buzzer_state":0}

```
 - **Config:**

```
{
  "n_channels":4,"n_alarms":10,"timestamp":43277.57437500,"frame_format":"array_static","channels_enabled":[0,1,0,1],
  "hash":"1C0606FF77D68DD1DBDD6D25AC773C76AF42D3BB","gmt":180,"tag_channels":["","Analog1","","","Analog3"],"tag_units":["","Celsius","","","Celsius"],"sp_alarms":[0.000,35.000,0.000,20.000,0.000,0.000,0.000,0.000,0.000,0.000]}

```
- **Dynamic Array:** Send information only about the enabled variables, grouping each parameter inside brackets.
 - **Status:**

```
{
  "n_channels":2,"n_alarms":4,"timestamp":43277.40706019,"battery":5.69,"value_channels":[22.300,22.300],"alarms":[1,0,1,0],"buzzer_state":0}

```
 - **Config:**

```
{
  "n_channels":2,"n_alarms":4,"timestamp":43277.57538194,"frame_format":"array_dynamic","channels_enabled":[1,1],"hash":"9401ACBDDFFD105D653DAE5222470B47127455BBC","gmt":-180,"tag_channels":["Analog1","Analog3"],"tag_units":["Celsius","Celsius"],"sp_alarms":[35.000,0.000,20.000,0.000]}

```
- **Static Descriptive:** Send information about all variables, even those that are not enabled, grouping each variable in unit mode.
 - **Status:**

```
{
  "n_channels":4,"n_alarms":10,"timestamp":43277.40924769,"battery":5.69,"ch_dig":0.000,"ch_analog_1":22.600,"ch_analog_2":0.000,"ch_analog_3":22.600,"alarm_01":0,"alarm_02":1,"alarm_03":0,"alarm_04":0,"alarm_05":0,"alarm_06":0,"alarm_07":0,"alarm_08":0,"alarm_09":0,"alarm_10":0,"buzzer_state":0}

```
 - **Config:**

```
{
  "n_channels":4,"n_alarms":10,"timestamp":43277.57784722,"frame_format":"descriptive_static","enabled_dig":0,"enabled_analog_1":1,"enabled_analog_2":0,"enabled_analog_3":1,"hash":"9401ACBDDFFD105D653DAE5222470B47127455BBC","gmt":-180,"tag_dig":["","tag_analog_1":"Analog1","tag_analog_2":["","tag_analog_3":"Analog3"],"unit_dig":["","unit_analog_1":"Celsius","unit_analog_2":["","unit_analog_3":"Celsius"],"sp_alarm_01":0.0,"sp_alarm_02":35.0,"sp_alarm_03":0.00,"sp_alarm_04":22.3,"sp_alarm_05":0.00,"sp_alarm_06":0.0,"sp_alarm_07":0.0,"sp_alarm_08":0.0,"sp_alarm_09":0.0,"sp_alarm_10":0.0}

```

- **Dynamic Descriptive:** Send information only about the enabled variables, grouping each variable in a unitary manner.
 - **Status:**

```
{ "n_channels":2, "n_alarms":4, "timestamp":43277.41043981, "battery":5.69, "ch_analog_1":22.800, "ch_analog_3":22.800, "alarm_02":1, "alarm_03":0, "alarm_04":0, "alarm_05":0, "buzzer_state":0 }
```
 - **Config:**

```
{ "n_channels":2, "n_alarms":4, "timestamp":43277.58234954, "frame_format":"descriptive_dynamic", "enabled_analog_1":1, "enabled_analog_3":1, "hash":"9401ACBDFFD105D653DAE5222470B47127455BBC", "gmt":180, "tag_analog_1":"Analog1", "tag_analog_3":"Analog3", "unit_analog_1":"Celsius", "unit_analog_3":"Celsius", "sp_alarm_02":35.0, "sp_alarm_03":0.00, "sp_alarm_04":22.3, "sp_alarm_05":0.00 }
```

8.4.3 BOOLEAN FORMAT

A Boolean data consists of a data type that basically has two values: 0 or 1 or false or true, with 0 being false and 1 being true. Both the MQTT protocol and **NXperience** software support that, according to the pattern chosen by the user, Boolean values are displayed in numeric format or in string format.

The **NXperience Boolean Format** parameter (see [MQTT Protocol](#) section of the [Configuration Software](#) chapter) tells you how Boolean variables will be displayed within the JSON frame, as you can see in the examples below.

- **Numeric:**

```
{ "n_channels":4, "n_alarms":4, "timestamp":43277.45657407, "battery":5.69, "value_channels":[0.000,23.400,0.000,23.400], "alarms":[0,1,0,0], "buzzer_state":0 }
```
- **String:**

```
{ "n_channels":4, "n_alarms":4, "timestamp":43277.45446759, "battery":5.69, "value_channels":[0.000,23.300,0.000,23.300], "alarms":[false,true,false,false], "buzzer_state":false }
```

9. MODBUS-TCP PROTOCOL

The **LogBox Wi-Fi** is compatible with the Modbus-TCP protocol, a data communication protocol used to connect the device to supervisory control and data acquisition (SCADA). It supports up to 4 simultaneous connections and allows up to 4 Modbus-TCP masters to monitor it at the same time.

In addition to enabling the **LogBox Wi-Fi** monitoring, if enabled in the configuration, it is possible to configure some parameters described in **Tables 10** and **11**. It is also possible to complete the configuration and logs download of **LogBox Wi-Fi** through the TCP/IP network. To do this, however, it is necessary to use the **NXperience** configurator software (see the [Configuration Software](#) chapter).

9.1 COMMANDS

It is important to note that the "Slave ID" parameter of the Modbus-TCP protocol can be filled with any value between 0 and 255. **LogBox Wi-Fi** is not a gateway, so it is only necessary to enter the IP address to perform the communication.

9.1.1 READ HOLDING REGISTERS – 0X03

This command can be used to read the value of one or even the maximum number of consecutive registers, as shown in **Table 09**.

9.1.2 WRITE HOLDING REGISTERS – 0X06

This command can be used to write in a register, as shown in **Table 10**.

9.1.3 WRITE MULTIPLE HOLDING REGISTERS – 0X16

This command can be used to write in multiple registers, as shown in **Table 10** and **Table 11**.

9.2 REGISTERS TABLE

Following is the table of registers supported by the device for the READ HOLDING REGISTERS commands:

ADDRESS	MNEMONIC	DESCRIPTION	INFORMATION
0	SERIAL_NUMBER_H	Device serial number (Higher part).	
1	SERIAL_NUMBER_L	Device serial number (Lower part).	
2	PRODUCT_CODE	Device code.	
3	FIRMWARE_VERSION	Firmware version.	Unit with two decimal places.
5	MAC_ADDR_WiFi_0_1	MAC Address Wi-Fi.	(XX:XX:00:00:00:00)
6	MAC_ADDR_WiFi_2_3	MAC Address Wi-Fi.	(00:00:XX:XX:00:00)
7	MAC_ADDR_WiFi_4_5	MAC Address Wi-Fi.	(00:00:00:00:XX:XX)
15	POWER_SUPPLY	Power supply.	<ol style="list-style-type: none"> 1. Battery 2. USB 3. External source
21	USB_STATUS	USB Interface status.	<ol style="list-style-type: none"> 1. Active USB voltage 2. Inactive USB voltage 3. COM port closed 4. COM port open
32	NUMBER_OF_ACTIVE_CHANNELS	Number of active channels.	
34	RECORDS_STARTED_INTERFACE	Indicates the interface responsible for initiating logs.	<ol style="list-style-type: none"> 1. Immediately start 2. Start by date/time 3. Start by keyboard 4. Start by digital input 5. Periodical start (Daily) 6. Start by software
35	RECORDS_STOPPED_INTERFACE	Indicates the interface responsible for stopping the logs.	<ol style="list-style-type: none"> 1. Finish by date/time 2. Finish by keyboard 3. Finish by digital input 4. Periodical finish (Daily) 5. Finish by software
36	STATUS_OF_RECORDS	Logs status.	<ol style="list-style-type: none"> 1. Stopped logs 2. Logging
37	NUMBER_OF_RECORDS_H	Number of logs in memory (Higher part).	
38	NUMBER_OF_RECORDS_L	Number of logs in memory (Lower part).	
39	NUMBER_OF_FREE_RECORDS_H	Number of logs available in memory (Higher part).	
40	NUMBER_OF_FREE_RECORDS_L	Number of logs available in memory (Lower part).	
43	FIRST_YEAR	Year of first log.	
44	FIRST_MONTH	Month of the first log.	

ADDRESS	MNEMONIC	DESCRIPTION	INFORMATION
45	FIRST_DAY	Day of the first log.	
46	FIRST_HOUR	Hour of the first log.	
47	FIRST_MINUTE	Minute of the first log	
48	FIRST_SECOND	Second of the first log.	
51	CURRENT_YEAR	Year of the last log.	
52	CURRENT_MONTH	Month of the last log.	
53	CURRENT_DAY	Day of the last log.	
54	CURRENT_HOUR	Hour of the last log.	
55	CURRENT_MINUTE	Minute of the last log.	
56	CURRENT_SECOND	Second of the last log.	
61	CHD_LAST_EVENT_YEAR	Year of the last digital input event.	
62	CHD_LAST_EVENT_MONTH	Month of the last digital input event.	
63	CHD_LAST_EVENT_DAY	Day of the last digital input event.	
64	CHD_LAST_EVENT_HOUR	Hour of the last digital input event.	
65	CHD_LAST_EVENT_MINUTE	Minute of the last digital input event.	
66	CHD_LAST_EVENT_SECOND	Second of the last digital input event.	
68	BUZZER_STATUS	Current buzzer status.	0. Inactive buzzer 1. Active buzzer
70	DIGITAL_OUT_VALUE	Digital output status.	0. Inactive output 1. Active output
71	CHD_LAST_EVENT_EDGE	Edge of the digital channel where the last event occurred.	0. Falling edge 1. Rising edge
73	CHD_STATUS	Digital channel status.	1. Ok 2. Underflow 3. Overflow
74	CHD_VALUE	Value of the last digital channel log.	In counts, if set to "Pulse Count" mode, or 1 or 0, if set in "Event Log" or "Record Control" modes, according to the logic level of the circuit.
75	CHD_VALUE_USER_UNIT_FLOAT_HIGH	Digital channel value in user unity (Float – high part).	
76	CHD_VALUE_USER_UNIT_FLOAT_LOW	Digital channel value in user unity (Float – low part).	
77	CHD_VALUE_MIN	Minimum value registered on digital channel.	
78	CHD_VALUE_MAX	Maximum value registered on digital channel.	
81	CH1_STATUS	Analog channel status 1.	1. Ok 2. Underflow 3. Overflow 4. Cold junction error 5. Open sensor
82	CH1_VALUE	Current value of analogue channel 1.	Decimal places: 1. For temperature sensors and the cold junction 2. For battery voltage and external power supply For linear sensors, the decimal point is configured.
83	CH1_VALUE_MIN	Minimum value registered on analog channel 1.	Decimal places: 1. For temperature sensors and the cold junction 2. For battery voltage and external power supply For linear sensors, the decimal point is configured.

ADDRESS	MNEMONIC	DESCRIPTION	INFORMATION
84	CH1_VALUE_MAX	Maximum value registered on analog channel 1.	Decimal places: 1. For temperature sensors and the cold junction 2. For battery voltage and external power supply For linear sensors, the decimal point is configured.
89	CH2_STATUS	Analog channel status 2.	1. Ok 2. Underflow 3. Overflow 4. Cold junction error 5. Open sensor
90	CH2_VALUE	Analog channel 2 current value.	Decimal places: 1. For temperature sensors and the cold junction 2. For battery voltage and external power supply For linear sensors, the decimal point is configured.
91	CH2_VALUE_MIN	Minimum value registered on analogue channel 2.	Decimal places: 1. For temperature sensors and the cold junction 2. For battery voltage and external power supply For linear sensors, the decimal point is configured.
92	CH2_VALUE_MAX	Maximum value registered on analogue channel 2.	Decimal places: 1. For temperature sensors and the cold junction 2. For battery voltage and external power supply For linear sensors, the decimal point is configured.
97	CH3_STATUS	Analog channel status 3.	1. Ok 2. Underflow 3. Overflow 4. Cold junction error 5. Open sensor
98	CH3_VALUE	Analog channel current value 3.	Decimal places: 1. For temperature sensors and the cold junction 2. For battery voltage and external power supply For linear sensors, the decimal point is configured.
99	CH3_VALUE_MIN	Minimum value recorded on analogue channel 3.	Decimal places: 1. For temperature sensors and the cold junction 2. For battery voltage and external power supply For linear sensors, the decimal point is configured.
100	CH3_VALUE_MAX	Maximum value recorded on analogue channel 3.	Decimal places: 1. For temperature sensors and the cold junction 2. For battery voltage and external power supply For linear sensors, the decimal point is configured.
106	BATTERY_VOLTAGE_VALUE	Current value of battery voltage.	Unit in volts with two decimal places.
107	BATTERY_VOLTAGE_VALUE_MIN	Minimum battery voltage value.	Unit in volts with two decimal places.
108	BATTERY_VOLTAGE_VALUE_MAX	Maximum battery voltage value.	Unit in volts with two decimal places.
109	BATTERY_PERCENTAGE_OF_LIFE	Battery life.	Unit in volts with two decimal places.

ADDRESS	MNEMONIC	DESCRIPTION	INFORMATION
113	EXTERNAL_VOLTAGE_VALUE	External voltage value.	Unit in volts with two decimal places.
114	EXTERNAL_VOLTAGE_VALUE_MIN	Minimum registered voltage of external source voltage.	Unit in volts with two decimal places.
115	EXTERNAL_VOLTAGE_VALUE_MAX	Maximum recorded value of external source voltage.	Unit in volts with two decimal places.
121	MQTT_LAST_UPDATE_YEAR	Year of last submission to the MQTT Broker.	
122	MQTT_LAST_UPDATE_MONTH	Month of last submission to the MQTT Broker.	
123	MQTT_LAST_UPDATE_DAY	Day of last submission to the MQTT Broker.	
124	MQTT_LAST_UPDATE_HOUR	Hour of last submission to the MQTT Broker.	
125	MQTT_LAST_UPDATE_MINUTE	Minute of last submission to the MQTT Broker.	
126	MQTT_LAST_UPDATE_SECOND	Second of last submission to the MQTT Broker.	
136	WIFI_IRSS	Signal quality between the device and the Wi-Fi Gateway.	Unit with signal in dB with two decimal places.
137	WIFI_GATEWAY_COM_STATUS	Wi-Fi communication status.	<ul style="list-style-type: none"> 0. Disconnected Gateway 1. Connected Gateway 2. Gateway password error 3. Gateway not found 4. Error receiving IP via DHCP 5. Authentication error
138	WIFI_MQTT_STATUS	Communication status with MQTT Broker.	<ul style="list-style-type: none"> 0. Disconnected Broker 1. Connected Broker 2. Error resolving DNS 3. Error when posting a message in Broker 4. Error when subscribing to topic
140	WIFI_IP_ADDR_0_1	Address of the device on the network (Higher part).	XXX.XXX.000.000
141	WIFI_IP_ADDR_2_3	Address of the device on the network (Lower part).	000.000.XXX.XXX
142	WIFI_MASK_ADDR_0_1	Network mask (Higher part).	XXX.XXX.000.000
143	WIFI_MASK_ADDR_2_3	Network mask (Lower part).	000.000.XXX.XXX
144	WIFI_GATEWAY_ADDR_0_1	Network Gateway address (Higher part).	XXX.XXX.000.000
145	WIFI_GATEWAY_ADDR_2_3	Network Gateway address (Lower part).	000.000.XXX.XXX
237	CHD_ACCUMULATED_VALUE_HIGH	Accumulator pulse count value (Higher part). Without conversion.	
238	CHD_ACCUMULATED_VALUE_LOW	Accumulator pulse count value (Lower part). Without conversion.	
239	CHD_ACCUMULATED_VALUE_FLOAT_HIGH	Accumulator pulse count value in the user unit (Float – higher part).	
240	CHD_ACCUMULATED_VALUE_FLOAT_LOW	Accumulator pulse count value in the user unit (Float – lower part).	

Table 9 – Registers Table

Below is the table of registers supported by the WRITE HOLDING REGISTERS and WRITE MULTIPLE HOLDING REGISTERS commands:

ADDRESS	MNEMONIC	DESCRIPTION	INFORMATION
68	BUZZER_STATUS	Current buzzer status.	<ul style="list-style-type: none"> 0. Inactive buzzer 1. Active buzzer
1044	SETTING_YEAR	Year setting in UTC (GMT 0).	
1045	SETTING_MONTH	Month setting in UTC (GMT 0).	
1046	SETTING_DAY	Day setting in UTC (GMT 0).	
1047	SETTING_HOUR	Hour setting in UTC (GMT 0).	
1048	SETTING_MINUTE	Minute setting in UTC (GMT 0).	
1049	SETTING_SECOND	Second setting in UTC (GMT 0).	

Table 10 – Registers table that allows writing (1)

Below is the table of registers supported only by the WRITE MULTIPLE HOLDING REGISTERS commands:

ADDRESS	MNEMONIC	DESCRIPTION	INFORMATION
211	ALARM_SETPOINT_01_HIGH	Setpoint configuration of alarm channel 01 (Higher part).	1 fixed decimal place.
212	ALARM_SETPOINT_01_LOW	Setpoint configuration of alarm channel 01 (Lower part).	1 fixed decimal place.
213	ALARM_SETPOINT_02_HIGH	Setpoint configuration of alarm channel 02 (Higher part).	1 fixed decimal place.
214	ALARM_SETPOINT_02_LOW	Setpoint configuration of alarm channel 02 (Lower part).	1 fixed decimal place.
215	ALARM_SETPOINT_03_HIGH	Setpoint configuration of alarm channel 03 (Higher part).	1 fixed decimal place.
216	ALARM_SETPOINT_03_LOW	Setpoint configuration of alarm channel 03 (Lower part).	1 fixed decimal place.
217	ALARM_SETPOINT_04_HIGH	Setpoint configuration of alarm channel 04 (Higher part).	1 fixed decimal place.
218	ALARM_SETPOINT_04_LOW	Setpoint configuration of alarm channel 04 (Lower part).	1 fixed decimal place.
219	ALARM_SETPOINT_05_HIGH	Setpoint configuration of alarm channel 05 (Higher part).	1 fixed decimal place.
220	ALARM_SETPOINT_05_LOW	Setpoint configuration of alarm channel 05 (Lower part).	1 fixed decimal place.
221	ALARM_SETPOINT_06_HIGH	Setpoint configuration of alarm channel 06 (Higher part).	1 fixed decimal place.
222	ALARM_SETPOINT_06_LOW	Setpoint configuration of alarm channel 06 (Lower part).	1 fixed decimal place.
223	ALARM_SETPOINT_07_HIGH	Setpoint configuration of alarm channel 07 (Higher part).	1 fixed decimal place.
224	ALARM_SETPOINT_07_LOW	Setpoint configuration of alarm channel 07 (Lower part).	1 fixed decimal place.
225	ALARM_SETPOINT_08_HIGH	Setpoint configuration of alarm channel 08 (Higher part).	1 fixed decimal place.
226	ALARM_SETPOINT_08_LOW	Setpoint configuration of alarm channel 08 (Lower part).	1 fixed decimal place.
227	ALARM_SETPOINT_09_HIGH	Setpoint configuration of alarm channel 09 (Higher part).	1 fixed decimal place.
228	ALARM_SETPOINT_09_LOW	Setpoint configuration of alarm channel 09 (Lower part).	1 fixed decimal place.
229	ALARM_SETPOINT_10_HIGH	Setpoint configuration of alarm channel 10 (Higher part).	1 fixed decimal place.
230	ALARM_SETPOINT_10_LOW	Setpoint configuration of alarm channel 10 (Lower part).	1 fixed decimal place.

Table 11 – Registers table that allows writing (2)

10. SMTP PROTOCOL

LogBox Wi-Fi is compatible with the Simple Mail Transfer Protocol (SMTP), a protocol designed to allow the sending of emails through the Internet through an e-mail server, such as Gmail, Yahoo, etc.



LogBox Wi-Fi does not support STARTTLS encryption, i.e., it is not possible to connect to a Hotmail (Outlook) e-mail server.

This feature makes it possible to send e-mails to up to 10 previously registered recipients during alarm situations configured and specified in the **NXperience** software (see section [Alarms Configuration](#) in the [Configuration Software](#) chapter).

Wi-Fi interface must be enabled for the SMTP protocol to work.

Emails sent through this protocol will contain the message configured in the SMTP tab of the **NXperience** communication tab, in addition to pertinent information regarding the alarm situation of each defined alarm, as can be seen in the example below:

From: Logboxwifi.std@gmail.com
 Date: Friday, January 25, 2019 04:09
 To: novus@novusautomation.com
 Subject: Alarm Alert

HIGH TEMP ALARM

LOGBOX WAITING ROOM - SN 16501402

HIGH TEMP

Fri, Jan 25, 2019. 04:09:02 PM

CH1 > CH2 + OFFSET
 LOGBOX ROOM 1 > LOGBOX ROOM 2 + 4.0
 30.8 Celsius > 25.7 + 4.0 Celsius

Each email should be viewed as follow:

Message Header	From: Logboxwifi.std@gmail.com Date: Friday, January 25, 2019 04:09
Addressee	To: novus@novusautomation.com
Subject matter	Subject: Alarm Alert
Message body	HIGH TEMP: Alarm
Information about the alarm	LOGBOX WAITING ROOM - SN 16501402 HIGH TEMP Fri, Jan 25, 2019. 04:09:02 PM CH1 > CH2 + OFFSET LOGBOX ROOM 1 > LOGBOX ROOM 2 + 4.0 30.8 Celsius > 25.7 + 4.0 Celsius

Table 12 – E-mail example

According to what has been shown above, each email has parameters that can be configured in **NXperience**, as shown below:

Message Part	NXperience
From: Logboxwifi.std@gmail.com Date: Friday, January 25, 2019 04:09	Corresponds to the sender of the email, which must be configured in the NXperience SMTP tab, and the date and time the message was sent.
To: novus@novusautomation.com	Corresponds to the recipient's e-mail, selected in the "Alarm Actions" section of each alarm configured on the NXperience Alarms tab. In it, you can select up to 10 registered contacts in the contacts' calendar. Each contact must first be registered in the "Recipients" section of the NXperience SMTP tab.
Subject: Alarm Alert	Corresponds to the e-mail title, which must be configured in the NXperience SMTP tab.
HIGH TEMP: Alarm	Corresponds to the text defined as a "Message Body" of the e-mail, which must be configured in the NXperience SMTP tab.

Message Part	NXperience
LOGBOX WAITING ROOM - SN 16501402	The first field corresponds to the tag given to the device in the NXperience General Parameters tab. The second field corresponds to the serial number of the device, which can also be seen on the General Parameters tab of NXperience .
HIGH TEMP	Corresponds to the tag given for the alarm, which can be set in the corresponding alarm in the NXperience Alarms tab.
Fri, Jan 25, 2019. 04:09:02 PM	Corresponds to the date and format of the time the alarm occurred and can be set in the Clock section of the NXperience General tab.
CH1 > CH2 + OFFSET	Corresponds to the channels analyzed and the offset value configured for the second channel to be compared and the operation defined for the alarm, which can be configured in the "Operation" parameter of each alarm in the NXperience Alarms tab.
LOGBOX ROOM 1 > LOGBOX ROOM 2 + 4.0	Corresponds to the checked tags in the NXperience Channels tab for the analyzed channels and the offset value set for the second channel to be compared and the operation that has been configured in the "Operation" parameter of each alarm in the NXperience Alarms tab.
30.8 Celsius > 25.7 + 4.0 Celsius	Corresponds to the reading of the configured channels and the offset value configured for the second channel to be compared and the operation that has been configured in the "Operation" parameter of each alarm in the NXperience Alarms tab.

Table 13 – Configurable parameters

11. DATA LOGGING

Data logging will be done in the **LogBox Wi-Fi** internal memory. The internal memory capacity is up to 140,000 logs. The number of logs that can be stored in the internal memory depends basically on the number of input channels that are enabled, as well as factors such as recording or not recording the digital input event.

Any channel types (analog and digital in the "Pulse Count" or "Event Log" modes) can be logged in memory. In the case of analog channels logs or digital input in "Pulse Count" mode, the logging will be periodic and will have its range configured through the configurator software. At the end of each log range, the current values of the enabled channels will be logged in the memory. In case the digital input is configured in the "Event Log" mode, the detected logs detected will be performed asynchronously to the periodicity of the other channels and will be performed when the event occurs.

There are several ways to start and end logs and many of them can be combined freely. During logging, all selected channels will be logged in the memory and the range between logs will be respected.

Depending on the type of start and end selected, there may be log "snippets" in the memory and, therefore, periods with no logged data. This is fully compatible with the device and is not a problem at all.

The device works with circular memory, which allows records to be continuously made. Once the memory is full, the oldest data will be paid so that the most recent data can be saved.

First, you must configure the start mode, chosen from the options below:

- **Immediate Start:** Allows logs to be started shortly after the device is reconfigured.
- **Date/Time:** Allows logs to be started at the configured date/time.
- **By Keyboard:** In a screen in the display, you can change the logs status to *enabled*, which start the logs (in case they had not been started yet).
- **By Digital Input:** Allows logs to be initiated from the digital input. For this option to be available, the digital input channel must have been set to "Logs Control" mode. There are four modes for controlling the digital input:
 - Start the logs at each rising edge.
 - Start the logs at each falling edge.
 - Log at logical level '1', which logs while at logical level '1'.
 - In this mode, the configured end mode should be "Logical level pause '0'".
 - Log at logical level '0', which logs while at logical level '0'.
 - In this mode, the configured end mode should be "Logical level pause '1'".
- **By Software:** Allows logs to be started using an **NXperience** command.
- **Daily:** It allows the logs to be started every day and at the configured time. The "Daily" log start mode also requires a "Daily" log end mode.
- **By Alarm:** Allows logs to be started from a specific alarm.

And you must configure the end mode, chosen from the options below:

- **Non-Stop:** Allows logs to continue indefinitely. When filling memory, the oldest data will be deleted so that the most recent ones can be saved.
- **Date/Time:** Allows logs to be ended at the configured date/time.
- **By Keyboard:** In a screen in the display, you can change the logs status to disabled, which start the logs (in case they had not been started yet).
- **By Digital Input:** Allows logs to be ended from the digital input. For this option to be available, the digital input channel must have been set to "Logs Control" mode. There are four modes for controlling the digital input:
 - Pause logs at each rising edge.
 - Pause logs at each falling edge.
 - Pause at logical level '0', which pauses while at logical level '0'.
 - In this mode the configured start mode should be "Logs in Logical level '1'".
 - Pause at logical level '1', which pauses while at logical level '1'.
 - In this mode the configured start mode should be "Logs in Logical level '0'".
- **By Software:** Allows logs to be started using an **NXperience** command.
- **Daily:** It allows the logs to be paused every day and at the configured time. The "Daily" log end mode also requires a "Daily" log start mode.
- **By Alarm:** Allows logs to be stopped from a specific alarm.

Number of Channels and Logs Maximum Capacity	
Number of Enabled Channels	Logs Maximum Capacity
1	143,147 logs from 1 channel
2	111,336 logs from 2 channels
3	91,093 logs from 3 channels
4	77,079 logs from 4 channels

Table 14 – Data Logging

12. ALARMS

The **LogBox Wi-Fi** allows you to define 10 alarms that can have different functionalities. Alarms will be shown on the display and can be set to activate an internal buzzer, to send e-mails to up to 10 users previously registered whenever an alarm situation is satisfied or if the Start and End of Logs Mode are set to "By Alarm" to start or stop the logs.

The general configuration parameters can be defined in the **NXperience** software (see section [General Channel Parameters](#) in the [Configuration Software](#) chapter) and are described below:

- **Buzzer Runtime:** Allows you to set a buzzer runtime for each time the device enters an alarm situation. The configuration will be performed in seconds, from 0 to 65000 s, where 0 means that the buzzer should not be triggered. The longer the buzzer runtime, the greater the battery consumption during the alarm situation.
- **Digital Output Mode:** Allows you to configure the digital output to follow an alarm situation. This way, whenever the alarm situation is satisfied, the Digital Output will be activated. The digital output will be disabled if no channel is an alarm situation.

When an alarm condition is satisfied, the **ALM** symbol will light up along with the **1**, **2**, **3**, **4** symbols, which correspond to the channels that satisfy the current state alarm situation. The **1**, **2**, **3**, **4** symbols indicate that the channel is currently in an alarm situation. The **ALM** symbol indicates that since the device was powered on or since the last alarm status was cleared, an alarm occurred. The retentive alarm statuses of each channel can be cleared through the display screens or through **NXperience**.

If two channels are compared to each other, the symbol for the main channel will light up.

For each enabled alarm, depending on the situation, specific values must be set for the following parameters:

- **Setpoint:** Allows you to set the value to be exceeded for the channel to satisfy the alarm situation.
- **Hysteresis:** Allows you to set the barrier to be exceeded for the channel to exit the alarm situation.
- **Range:** Allows you to set the range that will satisfy the alarm situation.

You can set a specific alarm to compare any channel with a preset setpoint, as well as a comparison between two channels. In any of these situations, you must define the operation to be performed:

- **Less than (<):** The alarm will be activated whenever the value of the main channel is less than the value of the secondary channel or when the value of the main channel is less than the configured setpoint.
- **Greater than (>):** The alarm will be activated whenever the value of the main channel is greater than the value of the secondary channel or when the value of the main channel is higher than the configured setpoint.
- **Within Range (=):** When performing a comparison between a channel and a setpoint, the alarm will activate when the value is within the predefined range, considering the setpoint value configured \pm the range. When performing a comparison between two channels, the alarm will be activated when the values of the two channels are within the value of the configured range.
- **Out of Range (\neq):** When comparing a channel with a setpoint, the alarm will be activated when the value is outside the predefined range, considering the setpoint value configured \pm the range. When performing a comparison between two channels, the alarm will be activated when the values of the two channels are outside the value of the configured range.
- **Sensor error:** The sensor will go into alarm if its reading exceeds the upper or lower channel limit, or if the sensor is disconnected. Function available only for analog channels.

In comparisons using the **Within Range (=)** or **Out of Range (\neq)** operations, the hysteresis will automatically be calculated as 10% of the configured range value. Thus, a configured alarm that is activated will only leave the alarm situation when, in addition to satisfying the configured range value, the 10 % hysteresis is also satisfied.

The status information of the configured alarms will be updated by any events that trigger an acquisition, which may be readings within the log range or in the display update range. If the main channel is one of the channels being logged, an extra log will be made in the memory as soon as it enters an alarm situation. The same process will occur when you leave the alarm situation.

If an alarm reaches a minimum or a maximum value, it may not be registered in memory. Thus, it is possible that the alarms report that the channel has already reached one of these situations and the information is not available in a download.

In case of an error value in the analog inputs, the alarm will remain as it was, except when using the **Sensor error** operator.

13. CONFIGURATION SOFTWARE

13.1 NXPERIENCE

The **NXperience** software is the main tool for configuring, downloading, and analyzing data for **LogBox Wi-Fi**. It allows for exploring all features and features of the device by communicating through its USB interface. It is also a complete tool for analyzing data logged by the **LogBox Wi-Fi**.

NXperience allows for joint graphic analysis of multiple data, performing mathematical calculations, issuing reports, and exporting data to several formats and is a complete configuration tool for the new **NOVUS** device line.

This manual describes the software's generic features. For instructions about device configuration, refer to the specific operating manual. The software can be downloaded free of charge from our website www.novusautomation.com, in the Downloads area.



Each time the device receives a new configuration through **NXperience**, the data in the logs internal memory will be erased and, therefore, there will be no publication By MQTT until new data is logged.

When a memory download is performed by **NXperience**, there will be a pause in the MQTT publication until the download is finished.

13.2 NXPERIENCE MOBILE

The **NXperience Mobile** application is the ideal tool for daily use of the **LogBox Wi-Fi**. Available for Android and iOS smartphones, the application offers convenience for monitoring or downloading data from the device. Through the Android or iOS sharing feature, you can export your registers data by email or store it in *Google Drive*, *Dropbox*, and any other Cloud storage tool.

NXperience Mobile can be downloaded for free from the Google Play Store or App Store.

The specific **NXperience Mobile** features are described in the [NXperience Mobile Specific Features](#) section.

13.3 CONFIGURING LOGBOX WI-FI WITH NXPERIENCE

It is possible to configure **LogBox Wi-Fi** by clicking the **Configure** button, located both on the **NXperience** (Windows) software home screen and on the **NXperience Mobile** application home screen, which has Android and iOS versions.

13.3.1 GENERAL PARAMETERS

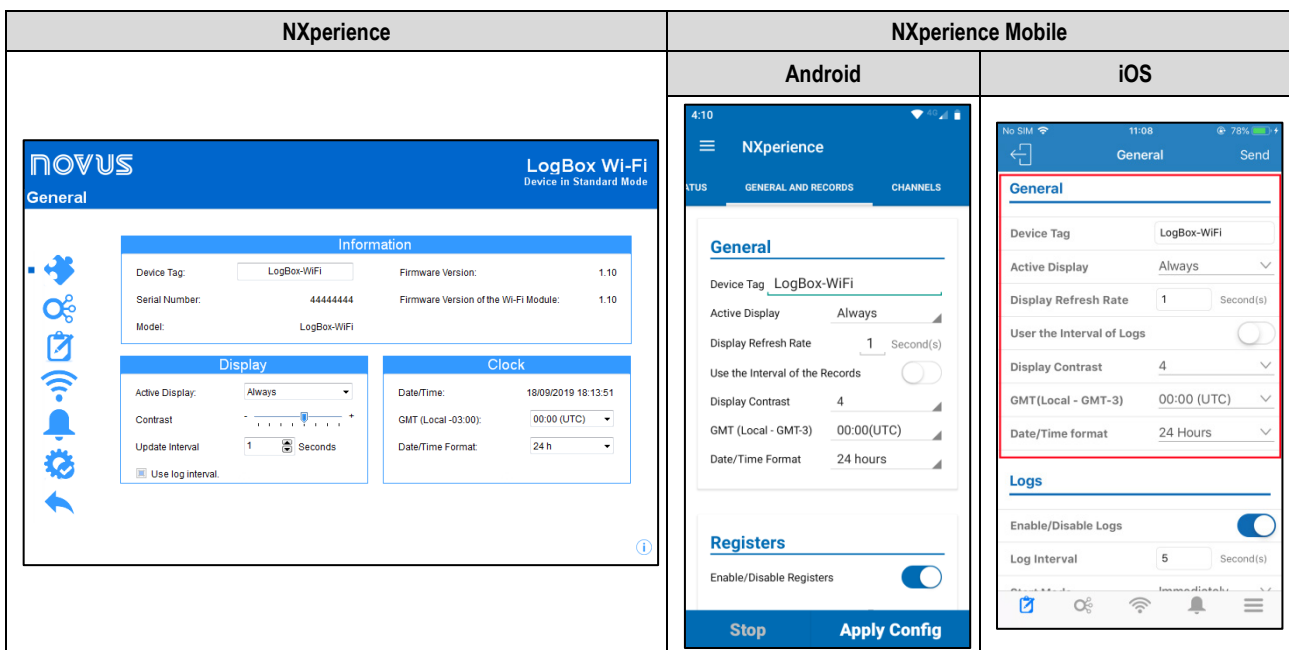

Figure 3 – General Parameters Screen

13.1.2.1 INFORMATION

- **Device Tag:** Allows you to set a name, which will be used as channel identification during a download, for the digital channel. The field accepts up to 16 characters.
- **Serial Number:** Shows the device unique identification number.
- **Firmware Version:** Shows the firmware version recorded in the device.
- **Firmware Version of the Wi-Fi Module:** Shows the firmware version of the device's Wi-Fi module.
- **Model:** Displays the device model name.

13.1.2.2 DISPLAY

- **Active Display:** Allows you to configure when the display should become active.
 - **Always:** If configured, it will keep the display active, following the configured contrast and update range.

- **By Keyboard:** If configured, the display will be activated whenever a key is pressed and will remain active for 1 minute (until a key is pressed again). This setting will follow the configured contrast.
- **Never:** If configured, it will keep the display off.
- **Contrast:** Allows you to configure the display contrast level. There are eight levels of contrast. The lowest level simplifies viewing at the upper and lower viewing angles and the higher-level simplifies viewing at the front viewing angle.
- **Update Interval:** Allows you to configure how often the display information will be updated.
 - **Use log interval:** If configured, it will cause the display information to be updated at each log range.
 - **Interval:** Allows you to set a display update range in seconds that is smaller than the log range. This way, the input channels will be read and will update the display at this range. The minimum range is 1 second; the maximum range is 18 hours.

13.1.2.3 CLOCK

- **Date/Time:** Allows you to set the date/time used to set the device clock.
- **GMT:** Allows you to configure the GMT of the place where the device will be used (preferably during first use). By default, **LogBox Wi-Fi** is set to GMT 0.
- **Date/Time Format:** Allows you to configure the clock format to 24 hours or AM/PM.

13.3.2 ANALOG CHANNELS PARAMETERS

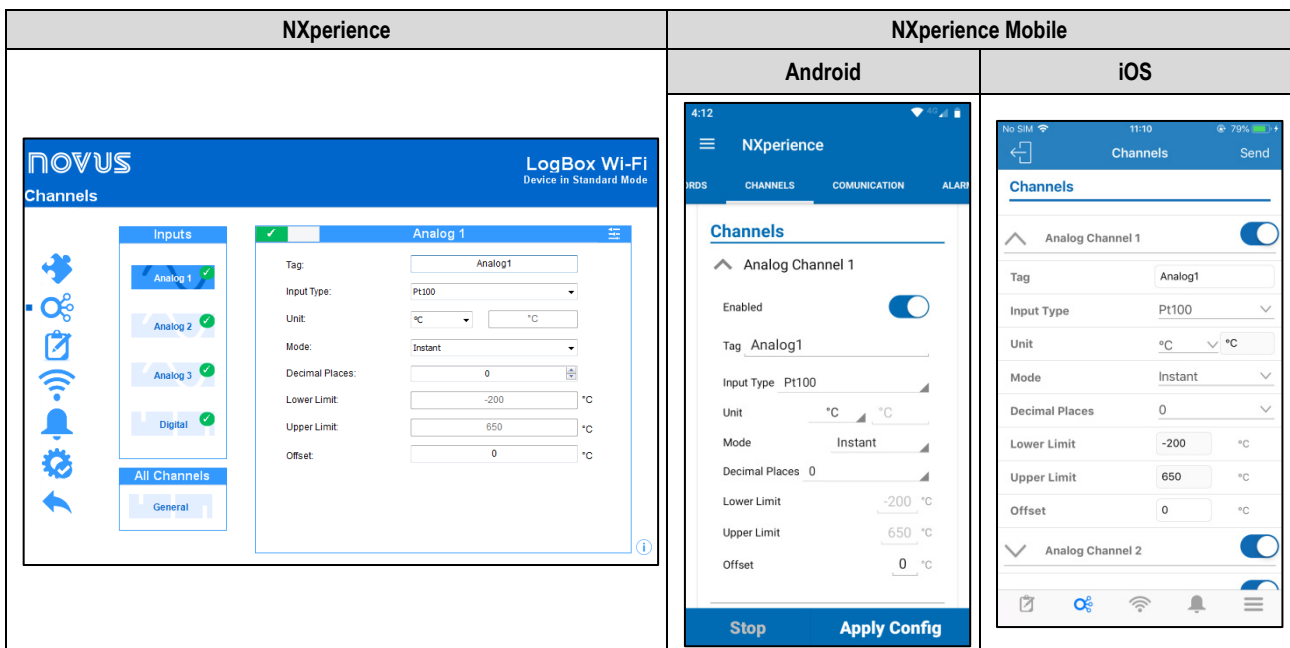



Figure 4 – Analog Channel Screen

- **Tag:** Allows you to set a name, which will be used as channel identification during a download, for the digital channel. The field accepts up to 16 characters.
- **Input Type:** Allows you to configure the type of sensor to be used in each analog channel.
- **Unit:** Allows you to configure the unit for each analog channel. In the case of temperature sensors, it is possible to select the units °C or °F. For other sensors, it is possible to describe the unit with up to eight characters.
- **Mode:** Allows you to configure the operation mode to use for each analog channel. If "Instant" mode is selected, the channel is read, and the value will be logged at each log range. If "Average" mode is selected, the device will take 10 channel readings within the log range and at each log range the average of these 10 readings will be logged.
- **Decimal Places:** Allows you to configure the number of decimal places of each analog channel. Temperature Sensors can be configured to show up to one decimal place. Other sensor types can be configured to show up to two decimal places.
- **Lower Limit:** If the sensor configured for the channel is a temperature or internal diagnostic sensor, the lower limit will be filled by the software with the sensor's lower limit. If the sensor configured for the channel is of the linear sensor type (mV, V, or mA), it will be necessary to fill in the desired value to represent the minimum value of the chosen sensor.
- **Upper Limit:** If the sensor configured for the channel is a temperature or internal diagnostic sensor, the upper limit will be filled by the software with the sensor's upper limit. If the sensor configured for the channel is of the linear sensor type (mV, V, or mA), it will be necessary to fill in the desired value to represent the maximum value of the chosen sensor.
- **Offset:** Allows you to make small adjustments to the readings of each channel. The configured Offset will be added to all readings performed on the configured channel.

13.1.2.1 CUSTOM CALIBRATION

The  icon opens the custom calibration screen, which allows you to adjust up to 10 measurement points for each channel. When a custom calibration has been configured, the minimum number of setpoints is two points.

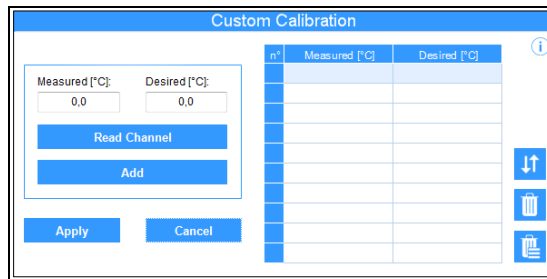





Figure 5 – Customized Calibration Screen

- **Measured:** Displays the device's read value for which a correction is desired. It can be obtained by clicking the "Read Channel" button or manually filled in.
- **Desired:** Shows the user's desired value for the device measured value. It must be filled manually.
- **Read Channel:** Allows you to obtain the device's values during a custom calibration.
- **Add:** Allows you to enter the "Measured" and "Desired" pair in the Custom Calibration table.
- **Modify:** Allows you to modify the "Measured" and "Desired" pair in the Custom Calibration table.
- **Organize** : Allows you to sort the Custom Calibration table.
- **Delete** : Allows you to delete the selected line from the Custom Calibration table.
- **Delete All** : Allows you to clear the entire Custom Calibration table.
- **Apply:** Allows you to apply the custom calibration to the channel being configured.
- **Cancel:** Allows you to cancel the Custom Calibration operation.

13.3.3 DIGITAL CHANNEL PARAMETERS

13.1.3.1 "PULSE COUNT" MODE

13.3.3.1.1 "PULSE COUNT" MODE: FLOW RATE

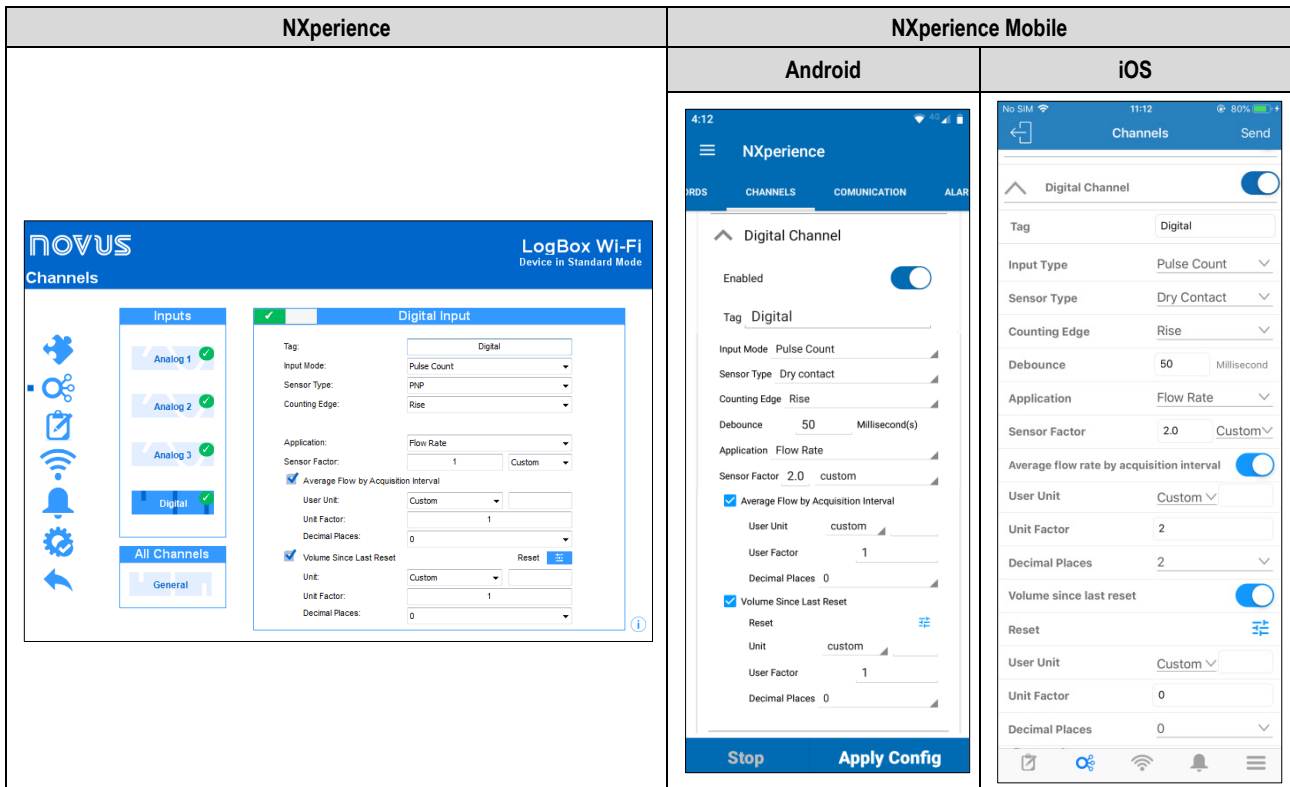

FIGURE 6 – "Pulse Count" Mode: Flow Rate

- **Tag:** Allows you to configure a 16-character name for the digital channel. This name will be used to identify the channel in a data download.
- **Input Mode:** Allows you to select the digital input mode. In this case, "Pulse Count" mode.
- **Sensor Type:** Allows you to configure the sensor type to be connected to the digital input: PNP, NPN, or Dry Contact.

- **Counting Edge:** Allows you to configure the desired counting edge. This way, the device will increment counts each time the configured edge is detected at the digital input. You can configure it to count on the Rising, Falling or Both edges.
- **Debounce:** If the sensor type configured is Dry Contact, it is necessary to set a debounce time for edge detection. The debounce is the sensor stabilization time (the minimum time at which the sensor must remain at the logical level of interest so that the detected edge is considered valid). The minimum configurable debounce time is 50 milliseconds and the maximum are 6 seconds.
- **Application:** Allows you to select the application type of the digital input. In this case, the "Flow Rate" mode.
- **Sensor Factor:** Allows you to configure the sensor factor used at the digital input. This parameter can be found in the sensor manual as *k-factor*. **LogBox Wi-Fi** provides three units for the sensor. The custom unit option can be selected to meet any need not previously listed by the device.
- **Average Flow by Acquisition Interval:** Allows you to configure the device to log the average flow rate per acquisition interval.
 - **User Unit:** Allows you to configure the flow rate unit related to the pulses counted at the digital input. **LogBox Wi-Fi** provides nine flow units. The custom unit option can be selected to meet any need not previously listed by the device. If this option is selected, the "Sensor Factor" and its respective unit need to be configured for the device to take counts and displays the flow rate in the configured unit.
 - **Custom:** Allows you to configure a custom unit for the digital input. The field allows for describing the unit with up to eight characters. If a custom unit is configured, it is necessary to configure the "Unit Factor" parameter, correlating it with the "Sensor Factor" parameter. See [Pulse Count](#) section.
 - **Unit Factor:** If the "User Unit" or the "Sensor Factor" parameters are configured in "Custom" mode, the "Unit Factor" parameter will need to be configured. The unit factor should relate the required unit to the sensor unit and the sensor factor will be used as a factor to be multiplied in the counts read from the digital input (See [Pulse Count](#) section).
 - **Decimal Places:** Allows you to configure the desired number of decimal places for displaying the calculated value, in flow, from the digital input.
- **Volume Since Last Reset:** Allows you to configure the device to log the volume since the last reset.
 - **Unit:** Allows you to configure the flow unit related to the pulses counted at the digital input. **LogBox BLE** provides nine flow units. The custom unit option can be selected to meet any need not previously listed by the device. If this option is selected, the "Sensor Factor" and its respective unit need to be configured for the device to take counts and displays the flow rate in the configured unit.
 - **Custom:** Allows you to configure a custom unit for the digital input. The field allows for describing the unit with up to eight characters. If a custom unit is configured, the "Sensor Factor" parameter will need to be configured. See [Pulse Count](#) section.
 - **Unit Factor:** If the "Unit" parameter or "Sensor Factor" unit are configured in "Custom" mode, the "Unit Factor" will need to be configured. The unit factor should relate the required unit to the sensor unit and the sensor factor will be used as a factor to be multiplied in the counts read from the digital input (See [Pulse Count](#) section).
 - **Decimal Places:** Allows you to configure the desired number of decimal places for displaying the calculated value, in flow, from the digital input.
 - **Reset:** See [Accumulator Resetting Modes](#) section.

13.3.3.1.2 "PULSE COUNT" MODE: COUNT

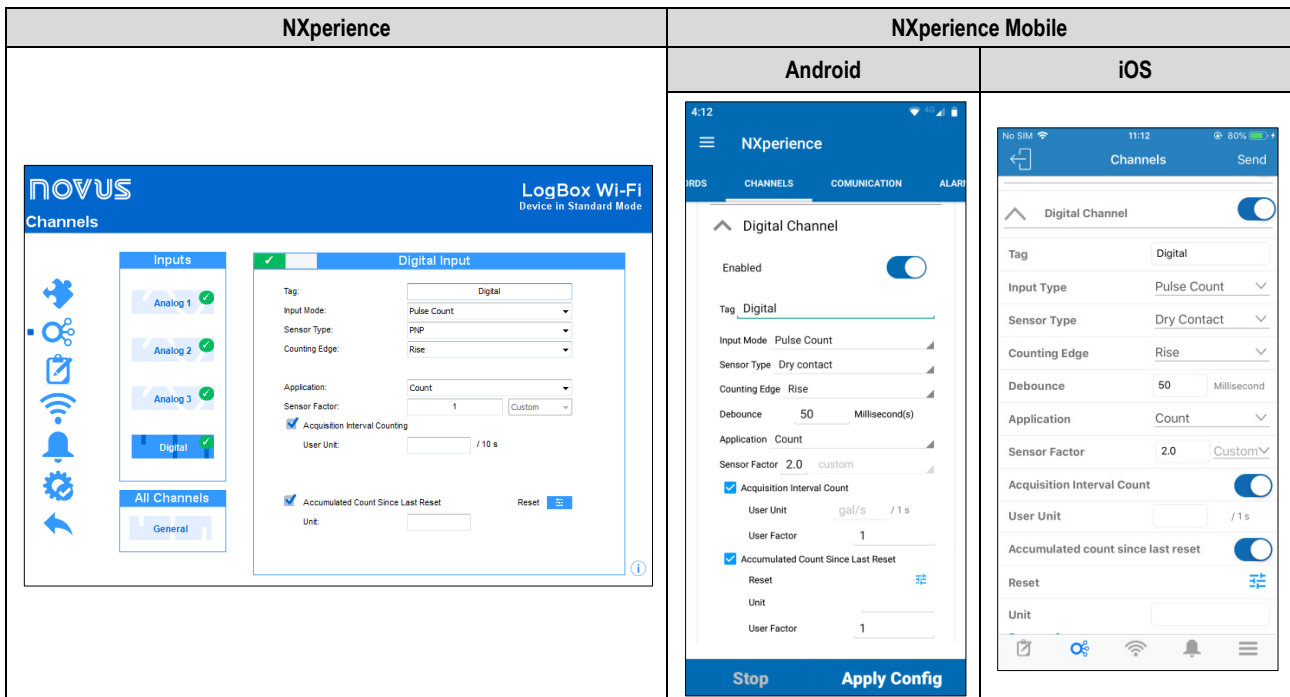

Figure 7 – "Pulse Count" Mode: Count

- **Tag:** Allows you to configure a name to be used as identification for the digital channel. The field accepts up to 16 characters.
- **Input Type:** Allows you to select the digital input mode. In this case, "Pulse Count" mode.
- **Sensor Type:** Allows you to configure the sensor type to be connected to the digital input: PNP, NPN or Dry Contact.
- **Counting Edge:** Allows you to configure the desired counting edge. This way, the device will increment counts each time the configured edge is detected at the digital input. You can configure it to count on the Rising, Falling or Both edges.

- **Debounce:** If the configured sensor type is Dry Contact, a debounce time will need to be configured for edge detection. Debounce is the sensor stabilization time – the minimum time at which the sensor must remain at the logical level of interest for the detected edge to be considered valid. The minimum configurable debounce time is 50 milliseconds; the maximum is 6 seconds.
- **Application:** Allows you to select the application type of the digital input. In this case, the type "Count".
- **Sensor Factor:** Allows you to configure the sensor factor used at the digital input. This parameter can be found in the sensor manual as *k-factor*. **LogBox Wi-Fi** provides three units for the sensor. The custom unit option can be selected to meet any need not previously listed by the device.
- **Acquisition Interval Counting:** Allows you to configure the device to log the performed count during the acquisition intervals.
 - **User Unit:** Allows you to configure a custom unit for the count performed per acquisition interval. The field allows you to describe the unit with up to eight characters.
- **Volume Since Last Reset:** Allows you to configure the device to log the accumulated count since the last reset.
 - **Unit:** Allows you to configure a custom unit for the count performed per acquisition interval. The field allows you to describe the unit with up to eight characters.
 - **Reset:** See [Accumulator Resetting Modes](#) section.

13.3.3.1.3 ACCUMULATOR RESETTING MODES

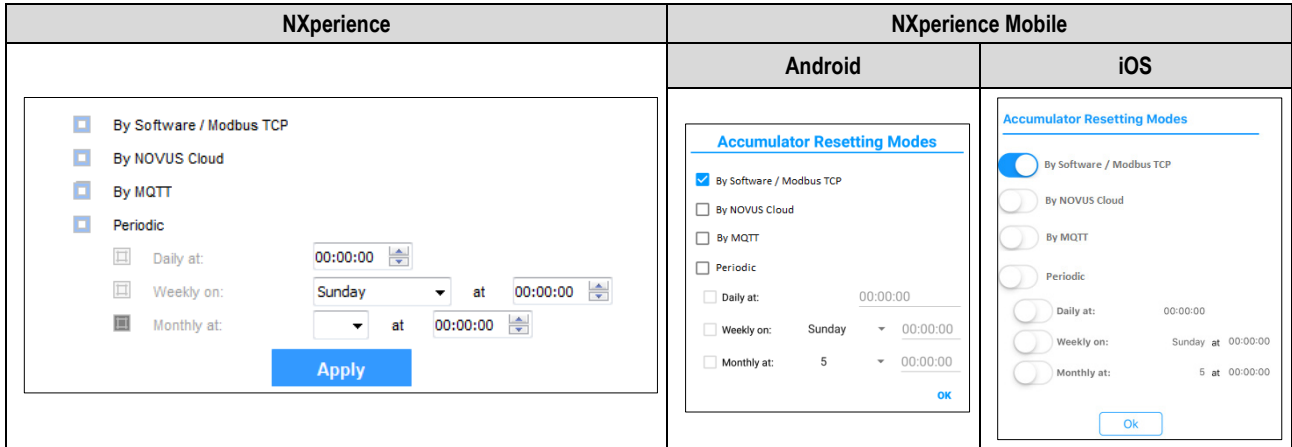

Figure 8 – Accumulator Resetting Modes

- **By Software:** If selected, it allows you to reset the accumulator by software.
- **By NOVUS Cloud:** If selected, it allows you to reset the accumulator by **NOVUS Cloud**. For this feature to be effective, you must properly configure the **NOVUS Cloud**. See section [Communication with Novus Cloud](#) for more information on how to configure the feature.
- **By MQTT:** If selected, it allows you to reset the accumulator by the MQTT protocol. For this feature to be effective, you must properly configure the MQTT protocol. See section [MQTT Protocol](#) for more information on how to configure the feature.
- **Periodic:** If selected, it allows you to reset the accumulator daily, weekly, monthly, and you can add time, day of the week or a date.

13.1.3.2 "EVENT LOG" OR "LOGS CONTROL" MODE

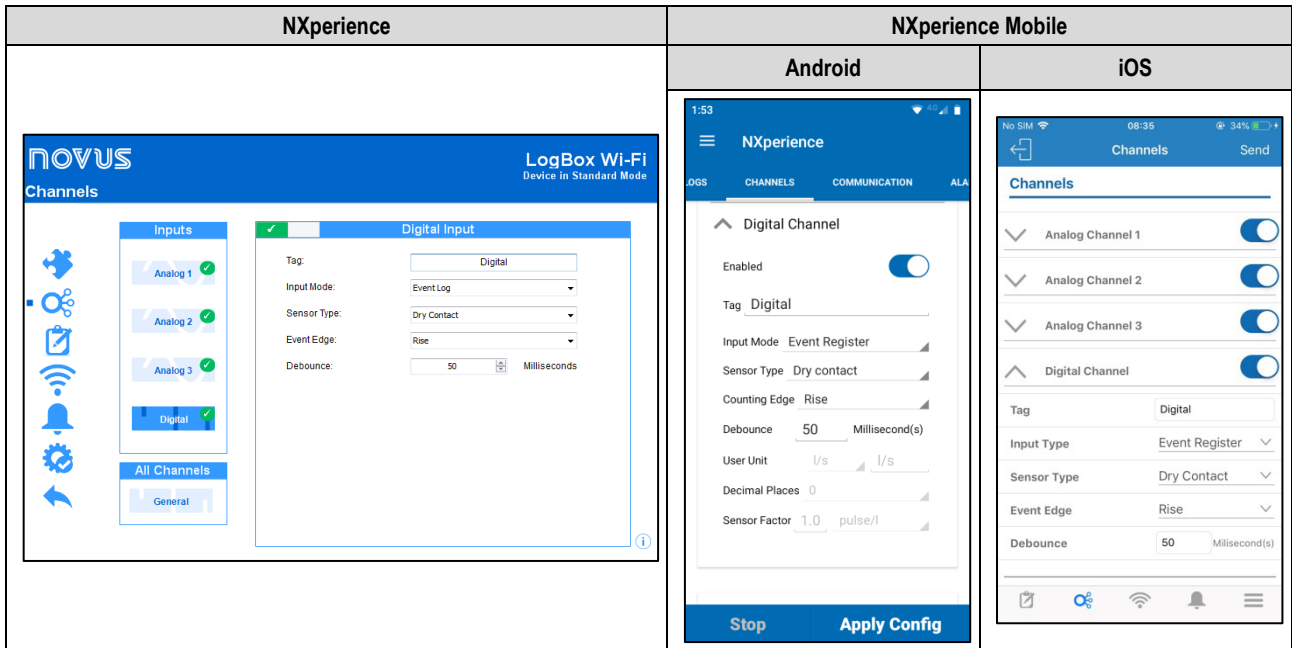

Figure 9 – Digital Input Screen: Event Log Mode

- **Tag:** Allows you to set a name, which will be used as channel identification during a download, for the digital channel. The field accepts up to 16 characters.
- **Input Mode:** Allows you to select the digital input mode, which has the options "Pulse Count", "Event Log", or "Logs Control". If the "Logs Control" mode is selected, the "By Digital Input" mode must be selected in the "Start Mode" and "End Mode" parameters in the "Data Logs" screen. Otherwise, the configuration will have no effect.
- **Sensor Type:** Allows you to configure the sensor type to be connected to the digital input: PNP, NPN, or Dry Contact.
- **Event Edge:** Allows you to configure the desired event edge. This way, the device will log events whenever the configured edge is detected at the digital input. In the "Event Log" mode, you can configure so that the logs are made during the Rising, Falling, or Both edges. In the "Logs Control" mode, it is possible to select to control logs at the Rising, Falling, or Both edges, logging at logic level '1' or logic level '0'.
- **Debounce:** It will be necessary to configure a debounce time for edge detection. Debounce refers to the sensor stabilization time – the minimum time at which the sensor must remain at the logical level of interest so that the detected edge is considered valid. The minimum configurable debounce time is 50 milliseconds; the maximum are 6 seconds. The device will only register the event after the end of the debounce time.

13.3.4 CHANNELS GENERAL PARAMETERS

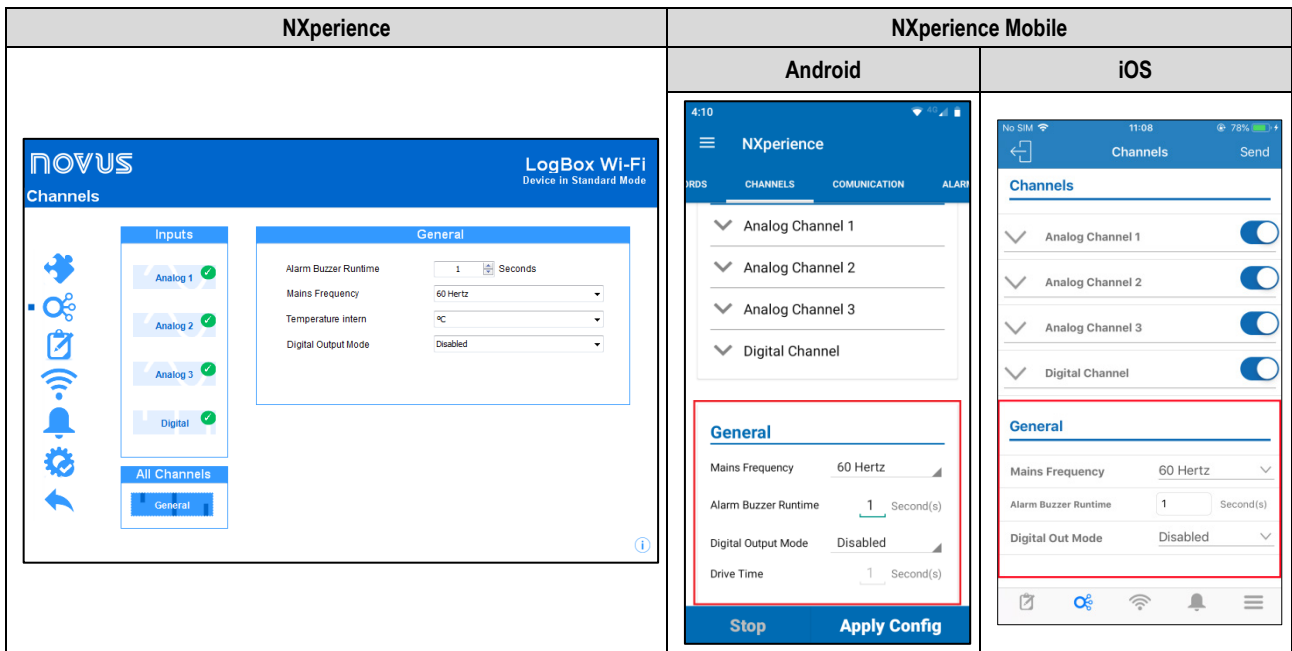

Figure 10 – Digital Input Screen: General Configuration

- **Alarm Buzzer Runtime:** Allows you to set the buzzer runtime for each time the device enters an alarm situation. The configuration will be performed in seconds, from 0 to 65000 s, where 0 means that the buzzer should not be triggered.
- **Mains Frequency:** Allows you to set the local power grid frequency (50 Hz or 60 Hz) for the device to perform better.
- **Intern Temperature:** Allows you to set the unit of measure in which the internal temperature will be displayed.
- **Digital Output Mode:** Allows you to configure the digital output mode, which can be configured as Disabled, Auxiliary Electronic Switch, or Alarm Status.
 - **Auxiliary Electronic Switch:** Allows you to control the power supply of external instruments during analog channel readings.
 - **Drive Time:** Allows you to configure, in seconds, how long before each acquisition the digital output must be triggered. The minimum configurable time is 0 seconds; the maximum time is 15 minutes (900 seconds). If equal to 0, the Auxiliary Electronic Switch will be enabled at the exact moment of an acquisition. If greater than or equal to the lowest acquisition range, the Auxiliary Electronic Switch will remain continuously enabled.
 - **Alarm Status:** In this mode, the digital output will follow the current and general alarm status. If any channel is in an alarm situation, the Digital Output will be enabled. If no channel is set to alarm, the Digital Output will be disabled.

13.3.5 LOG CONFIGURATION

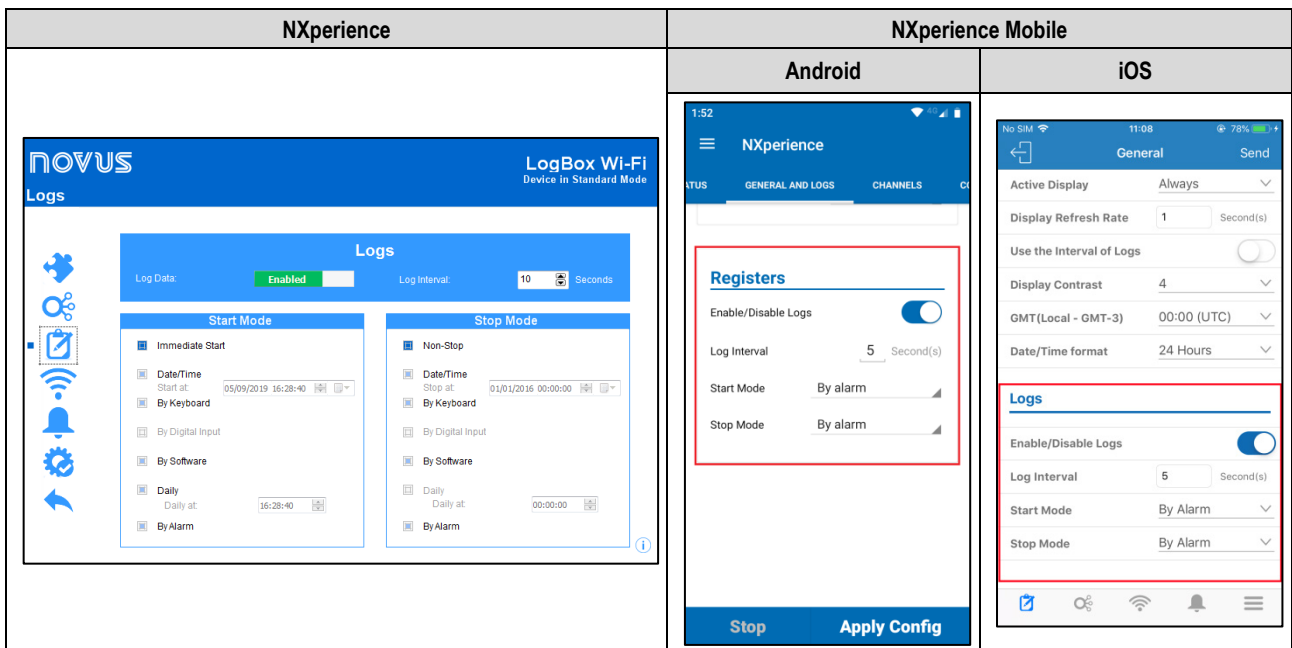

Figure 11 – Log Screen

13.1.5.1 LOGS

- **Log Data:** Enables or disables the device data logging.
- **Log Interval:** Allows you to select the frequency, in seconds, with which an acquisition must be made and logged in the memory.
 - **Minimum Range:**
 - 1 second - if no channel is configured to operate on average
 - 10 seconds - if a channel is configured to operate on average
 - **Maximum Range:** 18 hours.

13.1.5.2 START MODE

- **Immediate Start:** Allows logs to be started shortly after the device is reconfigured.
- **Date/Time:** Allows you to set the date/time when the logs are to be started.
- **By Keyboard:** In a screen in the display, you can change the logs status to *enabled*, which start the logs (in case they had not been started yet).
- **By Digital Input:** Allows logs to be initiated from the digital input. This parameter is available if the digital input is enabled and configured in the "Logs Control" mode. This way, the logs will be started the moment the digital input is triggered. The log edge shall be configured in the digital input parameters.
- **By Software:** Allows logs to be started using an **NXperience** command.
- **Daily:** It allows the logs to be started every day and at the configured time. The "Daily" log start mode also requires "Daily" log end mode.
- **By Alarm:** Allows logs to be started from a specific alarm.

13.1.5.3 STOP MODE

- **Non-Stop:** Allows logs to continue indefinitely. When filling the memory, the oldest data will be deleted so that the most recent ones can be saved.
- **Date/Time:** Allows you to set the date/time when the logs are to be ended.
- **By Keyboard:** Allows you to change logs status to *disabled* on a screen in the display by instantly closing the logs.
- **By Digital Input:** Allows logs to be paused from the digital input. This parameter is available if the digital input is enabled and configured in the "Logs Control" mode. This way, the logs will be paused the moment the digital input is triggered. The log edge shall be configured in the digital input parameters.
- **By Software:** Allows logs to be ended using an **NXperience** command.
- **Daily:** It allows the logs to be ended every day and at the configured time. The "Daily" log start mode also requires "Daily" log end mode.
- **By Alarm:** Allows logs to be stopped from a specific alarm.

The combinations allowed for starting and ending logs are as follows:

START MODE	STOP MODE
Immediate	Non-Stop or Date/Time or Keyboard or Software or Alarm
Date/Time	Non-Stop or Date/Time or Keyboard or Software or Alarm
Digital Input	Non-Stop or Digital Input
Keyboard	Non-Stop or Keyboard
Software	Non-Stop or Software
Daily	Daily
Alarm	Non-Stop or Alarm

Table 15 – Logs End Modes

13.3.6 COMMUNICATION PARAMETERS

13.3.6.1 WI-FI CONFIGURATION

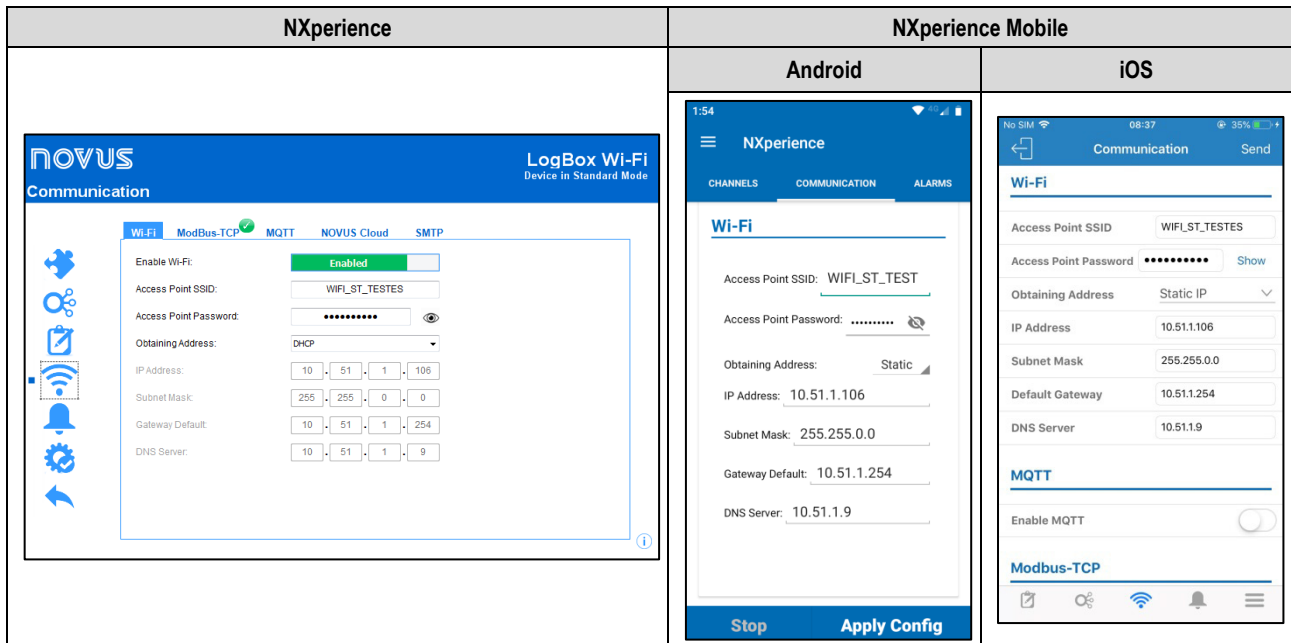

Figure 12 – Configuration Screen

- **Enable Wi-Fi:** Allows you to enable or disable this communication interface. When disabled, the MQTT parameters will remain disabled. When the **LogBox Wi-Fi** does not have an external power supply and is running on batteries, this interface will be automatically disabled.
- **Access Point SSID:** Allows you to enter the name of the Wi-Fi network to which **LogBox Wi-Fi** will try to connect to. The field accepts up to 32 alphanumeric characters.
- **Access Point Password:** Allows you to enter the Wi-Fi network password to which **LogBox Wi-Fi** will try to connect to. The field accepts up to 40 alphanumeric characters.
- **Obtaining Address:** Allows you to determine how **LogBox Wi-Fi** will try to acquire an IP: DHCP (*Dynamic Host Configuration Protocol*), protocol that allows the device's IP (*Internet Protocol*) to be assigned by the network server, or Static, which allows the user to set the IP address, subnet mask, and default gateway for the connection. In this case, you can also set the DNS (*Domain Name System*).
- **IP Address:** Refers a device identification (computer, printer, etc.) on a local or public network. Each computer or device on the Internet or on an internal network has a unique IP. This is a required field when "Obtaining Address" is marked as "Static".
- **Subnet Mask:** Also known as *subnet mask* or *netmask*, it allows you to divide a specific network into smaller subnets, making it more effective to use a particular IP address space. This is a required field when "Obtaining Address" is marked as "Static".
- **Gateway Default:** Refers to the device address on the network that connects your computers to the internet. This is a required field when "Obtaining Address" is marked as "Static".
- **DNS Server:** Refers to a hierarchical and distributed name management system for computers, services, or any resource connected to the Internet or a private network. This is an optional field when "Obtaining Address" is marked as "Static".

13.3.6.2 MODBUS-TCP PROTOCOL

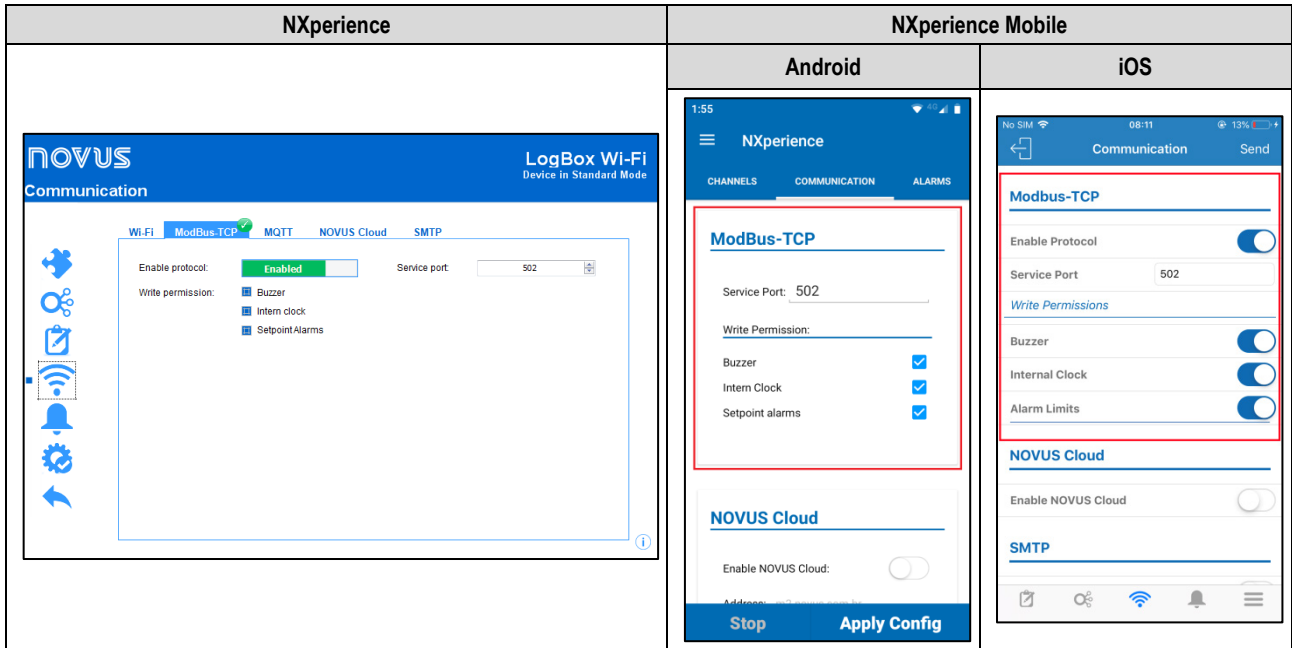

Figure 13 – Configuration Screen: Modbus-TCP

- **Enabled Protocol:** Enables the Modbus-TCP service.
- **Service Port:** Allows you to define the TCP port on which the service will be available.
- **Write Permission:** Allows you to select which logs will be available for user writing via Modbus-TCP.

13.3.6.3 MQTT PROTOCOL

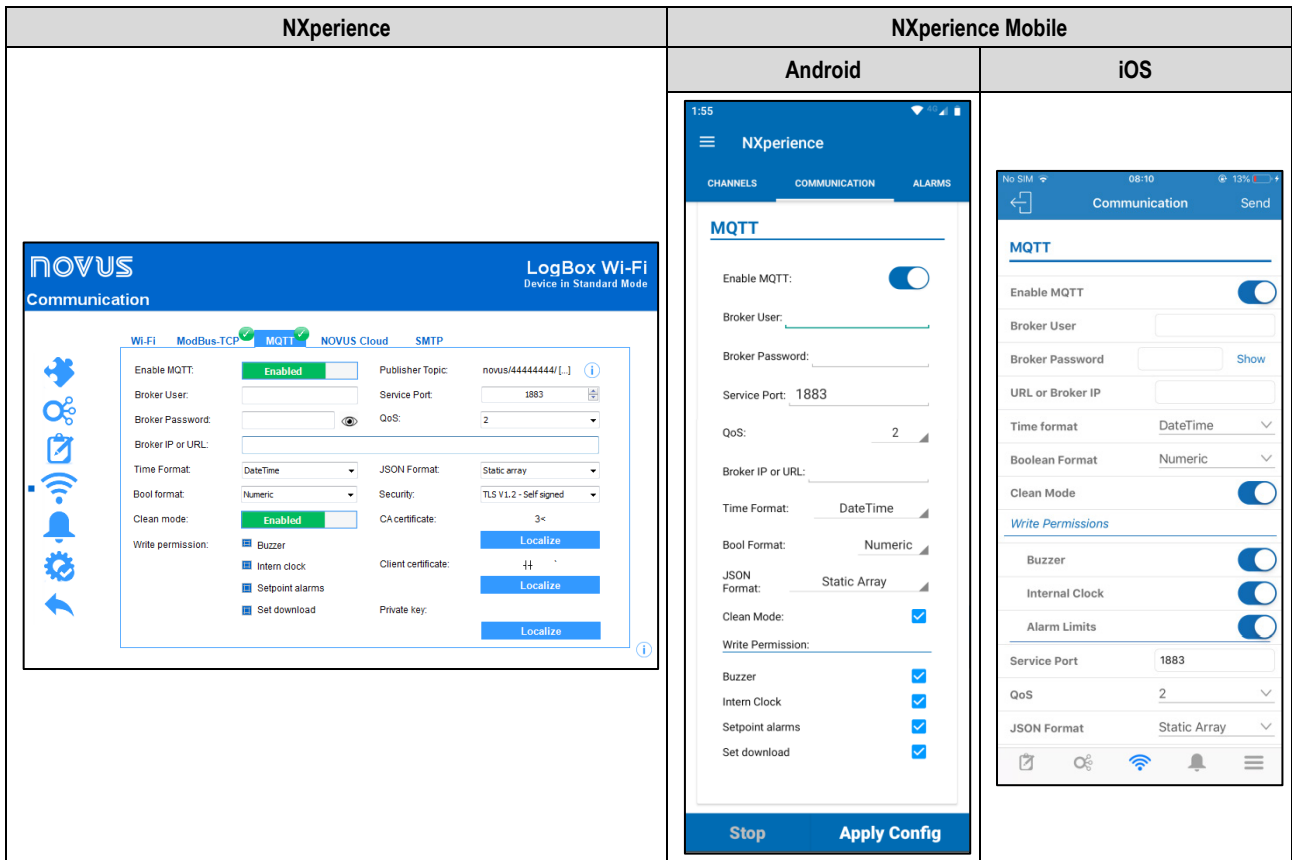

Figure 14 – Configuration Screen: MQTT

- **Enable MQTT:** Enables or disables data submission by MQTT protocol. When the **LogBox Wi-Fi** does not have an active external power supply and is running on batteries, the Wi-Fi interface will remain disabled and, therefore, sending data through this protocol as well.
- **Broker User:** Allows you to enter the registered user's login on the Broker. The field accepts up to 40 characters. If the field is empty, the connection will be made in anonymous mode.
- **Broker Password:** Allows you to enter the registered user's password on the Broker. The field accepts up to 40 characters. If the field is empty, the connection will be made in anonymous mode.

- **Broker URL or IP:** Allows you to enter the Broker address, which can be a URL (*Uniform Resource Locator*) or an IP. The field accepts up to 60 characters.
 - **Time Format:** Allows you to choose the time format to display: DateTime or Unix Timestamp. Changes the sent date/time format of the JSON frame.
 - **Boolean Format:** Indicates how Boolean variables will be displayed in the JSON frame. For more information, check the [Boolean Format](#) section of the [MQTT Protocol](#) chapter.
 - **Clean Mode:** When enabled, it indicates to the Broker that it is necessary to store only the last data of each topic. By disabling this option, the Broker, if configured, will keep all historical data stored.
 - **Write Permissions:** Selects which commands will be available for user writing via MQTT.
 - **Publication Topic:** Allows you to view the subscription and publication topic formats.
 - **Service Port:** Allows you to define the port number used to connect to the Broker.
 - **QoS:** The "Quality of Service" parameter allows you to select the level of quality of service used to send MQTT messages. Your options are 0, 1, or 2. For more information, check the [QoS](#) section of the [MQTT Protocol](#) chapter.
 - **JSON Format:** Changes the formatting of the JSON frame as required by the supervisor. For more information, check the [JSON Format](#) section of the [MQTT Protocol](#) chapter.
 - **Security:** Allows you define the security protocol and data encryption to be used by the MQTT Broker.
 - **None:** None security measures will be used.
 - **TLS V1.2 – CA Only:** If this option is selected, the Broker will use the Transport Layer Security (TLS) 1.2 protocol, which requires a TLS certificate recognized by a certification authority (CA), to ensure the privacy and integrity of the data.
 - **TLS V1.2 – Self Signed:** If this option is selected, the Broker will use the Transport Layer Security (TLS) 1.2 protocol, which, in addition to the TLS certificate recognized by a certification authority (CA), also requires authentication of the client certificate and its private key to ensure privacy and integrity of the data.
- Note:** CA certificate, client certificate and private key files are accepted in .pem and .der formats only.

13.3.6.4 NOVUS CLOUD CONFIGURATION

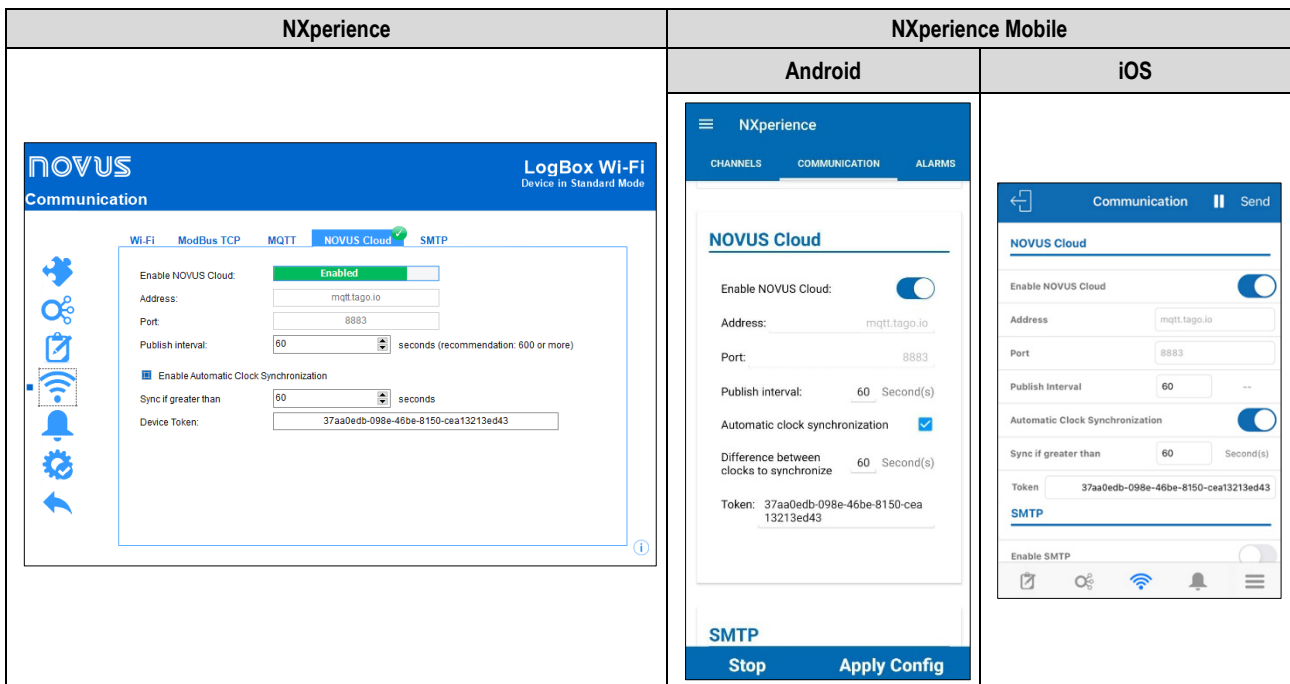

Figure 15 – Configuration Screen: NOVUS Cloud

- **Enable NOVUS Cloud:** Allows for enabling **NOVUS Cloud** publication functions (see the [Communicating with NOVUS Cloud](#) chapter for additional information). When the **LogBox Wi-Fi** does not have an active external power supply and is running on batteries, the Wi-Fi interface will remain disabled and, therefore, sending data through this protocol as well.
- **Address:** Informs the platform address. Non-editable parameter.
- **Port:** Informs the port number used for connecting to the platform. Non-editable parameter.
- **Publishing Interval:** Allows for selecting the interval, in seconds, at which **LogBox Wi-Fi** will publish data pending in the memory to **NOVUS Cloud**.
- **Enable automatic clock synchronization:** If selected, it allows you to enable the automatic clock update feature through **NOVUS Cloud**. See parameter **Sync if longer than** for more information about this feature.
 - **Sync if longer than:** If the automatic clock synchronization feature is enabled, the parameter will determine the maximum time (in seconds) difference between the **LogBox Wi-Fi** clock and the **NOVUS Cloud** server to update the **LogBox Wi-Fi** clock.
 - **Device Token:** This field must be filled in with the token obtained when registering the device to **NOVUS Cloud**. For more information about the token, see chapter 5 of **NOVUS Cloud** manual.

13.3.6.5 SMTP PROTOCOL

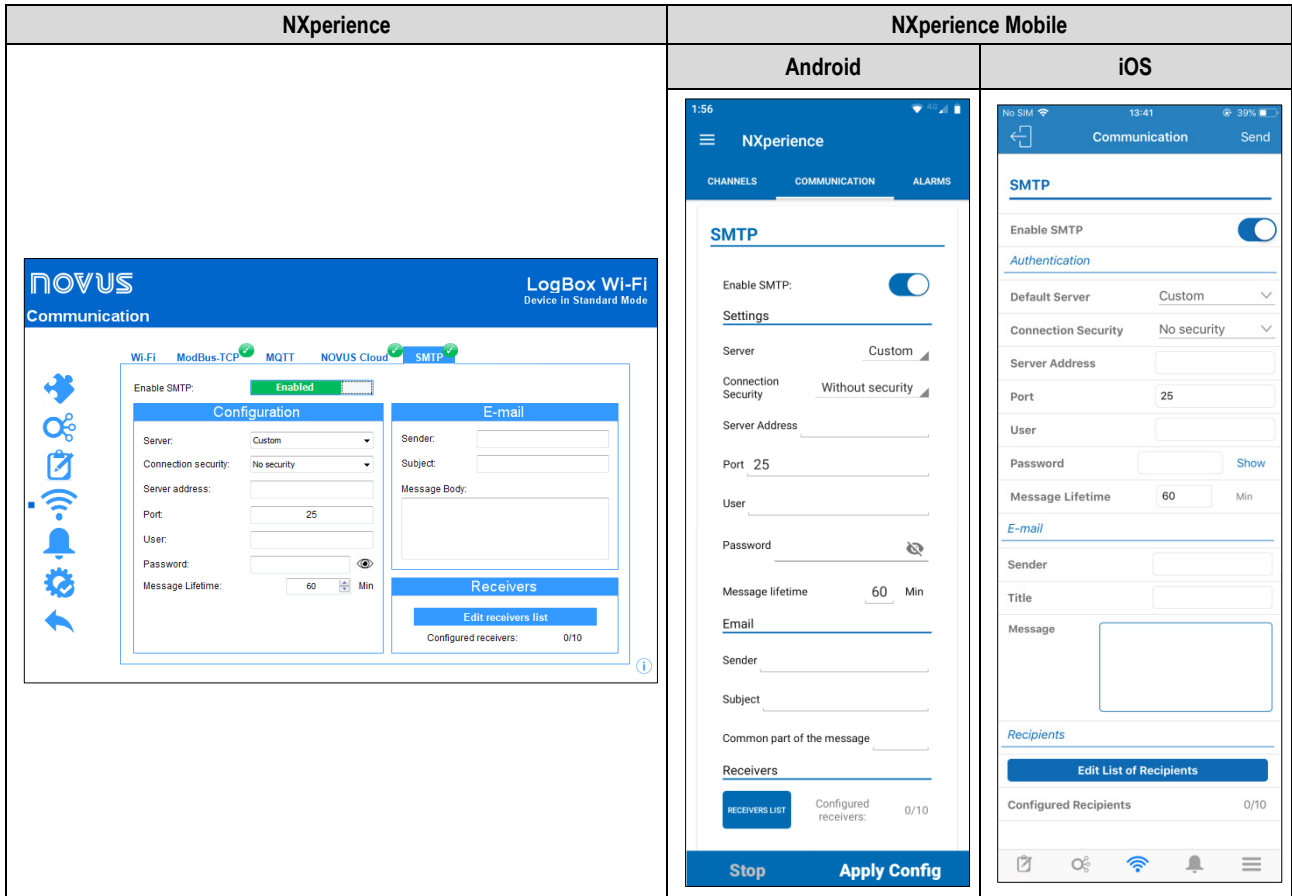

Figure 16 – Configuration Screen: SMTP

- **Enable SMTP:** Allows you to enable or disable e-mail sending features (see [SMTP Protocol](#) chapter). When the **LogBox Wi-Fi** does not have an external power source active and is running on batteries, the Wi-Fi interface will remain disabled and therefore will send data through this protocol as well.
- **Configuration:** Allows you to enter the data required to perform the user authentication on the selected server.
 - **Server:** Allows you to select the server of the email to be used.
 - **Connection Security:** Allows you to select the security mode of the connection, which may occur in an insecure way or with the TLS protocol.
 - **Server Address:** Allows you enter the address of the email server to be used.
 - **Port:** Allows you to enter the connection port to be used by the e-mail server.
 - **User:** Allows you to enter the username of the e-mail to be used.
 - **Password:** Allows you to enter the password of the user of the e-mail to be used.
 - **Message Lifetime:** Allows you to set how long ago the device will evaluate the logs to send an alarm e-mail. This parameter will also prevent the user from receiving e-mails with alarm messages registered outside the period of interest. You can set a minimum limit of 1 minute or a maximum limit of 200 hours.
- **E-mail:** Allows you to enter the sender's e-mail, a title and the message that will be sent to the downloaded data about the configured alarm.
 - **Sender:** Allows you to enter the sender's e-mail address for the e-mail to be sent.
 - **Subject:** Allows you to enter the subject of the e-mail to be sent.
 - **Message Body:** Allows you to enter the message that will be sent to the downloaded data about the configured alarm. The message body will be identical for all emails.
- **Recipients:** Allows you to create and edit the recipient list. You can register up to 10 e-mails.

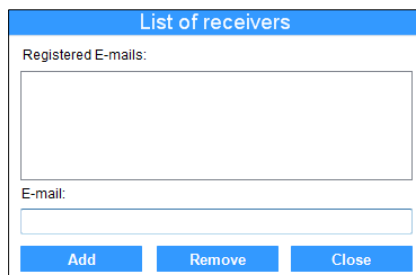

Figure 17 – Receivers List

13.3.7 ALARMS CONFIGURATION



NXperience	NXperience Mobile	
	Android	iOS
	Clicking on the alarm button will enable or disable it.	
		
	Clicking on the alarm will allow you to configure it.	
		

Figure 18 – Alarms screen

- **Tag:** Allows you to set a name, which will be used as alarm identification, for each alarm enabled. The field allows up to 16 characters.
- **Operation:** Allows you to select the operation to be performed by the alarm enabled. This feature has three parameters, which allow you to select the channels or setpoint to be analyzed and the operation to be performed (see chapter [Alarms](#)).
 - **Setpoint:** Allows you to set the value to be exceeded for the channel to satisfy the alarm situation.
 - **Hysteresis:** Allows you to set the barrier to be exceeded for the channel to exit the alarm situation.
 - **Range:** Allows you to set the range that will satisfy the alarm situation.

	<p>When configuring the alarm for a digital input that is configured for "Event Log" or "Logs Control" mode, you can only use the '=' comparison with Setpoints '0' or '1', since the alarm will be used to compare with the logic level of the channel. Also, it is important to note that if configured for "Event Edge: Rise" or "Event Edge: Fall", the alarm may never enter or never leave the alarm state. Thus, for the alarm to operate correctly, it is recommended to use the "Event Edge: Both" option.</p>
---	---

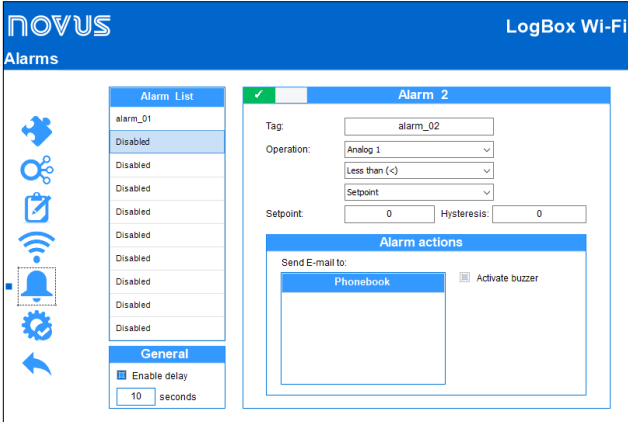
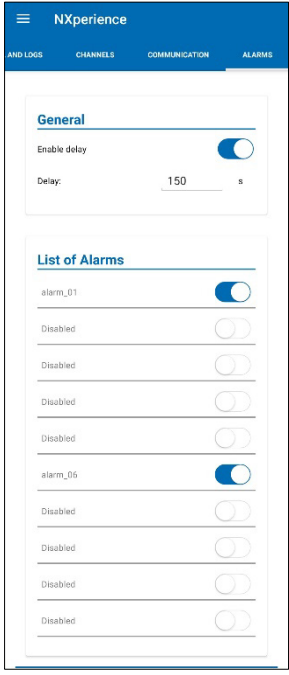
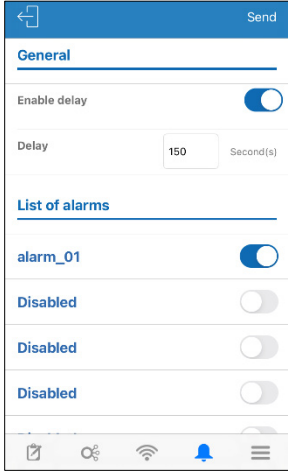
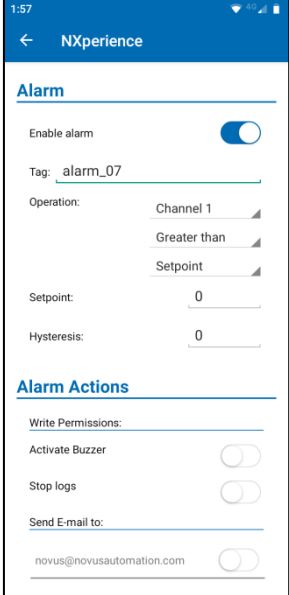
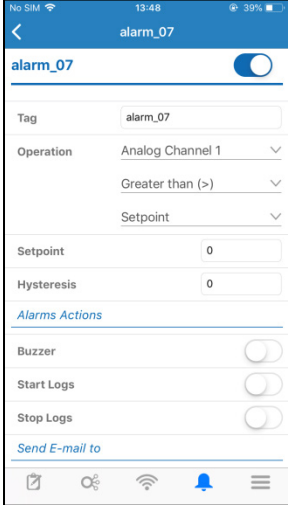
- **General:** Allows you to enable or disable the alarm delay option.
 - **Enable delay:** Allows you to enable the delay of configured alarms. Once enabled, the device will only consider an alarm if the setpoint is exceeded and maintained for a timer longer than the configured delay.

- **Configure seconds:** Allows you to configure the delay period to be considered. Maximum value: 3600 seconds.

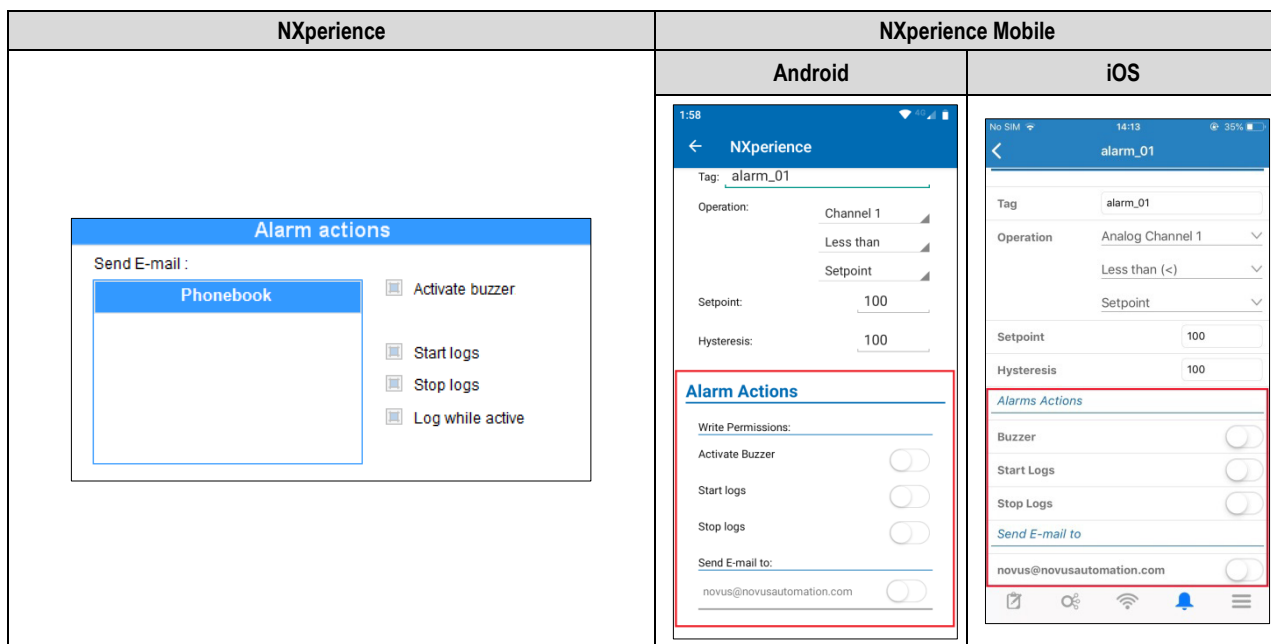

Figure 19 – Alarm actions

- **Alarm Actions:** Allows you to select the actions to be taken whenever the configured alarm enters an alarm situation.
 - **Send E-mail to:** Allows you to select the contacts that should receive this alarm notification (see [SMTP Protocol](#) section of the [Configuration Software](#) chapter).
 - **Activate Buzzer:** Allows you to select so that the buzzer is activated whenever the configured alarm goes into alarm.
 - **Start Logs:** If the Log Start Mode is set to "By Alarm", it allows you to start logging every time the alarm goes into alarm. The "Start Logs" and "Stop Logs" actions are mutually exclusive. Once an alarm has been set to start the logs whenever the device enters alarm situation, it will not be possible to use the same alarm to stop them.
 - **Stop Logs:** If Log Stop Mode is set to "By Alarm", it allows you to stop logging every time the alarm goes into alarm. The "Start Logs" and "Stop Logs" actions are mutually exclusive. Once an alarm has been set to stop the logs whenever the device enters alarm situation, it will not be possible to use the same alarm to start them.
 - **Log while Active:** If the Start Mode and Stop Mode are set to "By Alarm", it allows you to register whenever the configured alarm is set to alarm. If the configured alarm is no longer in alarm, the device will automatically stop logging. If an alarm has been set in the "Start Logs" or "Stop Logs" modes, it will not be possible to set any alarm in the "Log while Active" mode. Unlike the previous modes, which allow only a single alarm to be configured for each action, this mode has many alarms.

13.1.7.1 COMPARISON BETWEEN CHANNELS

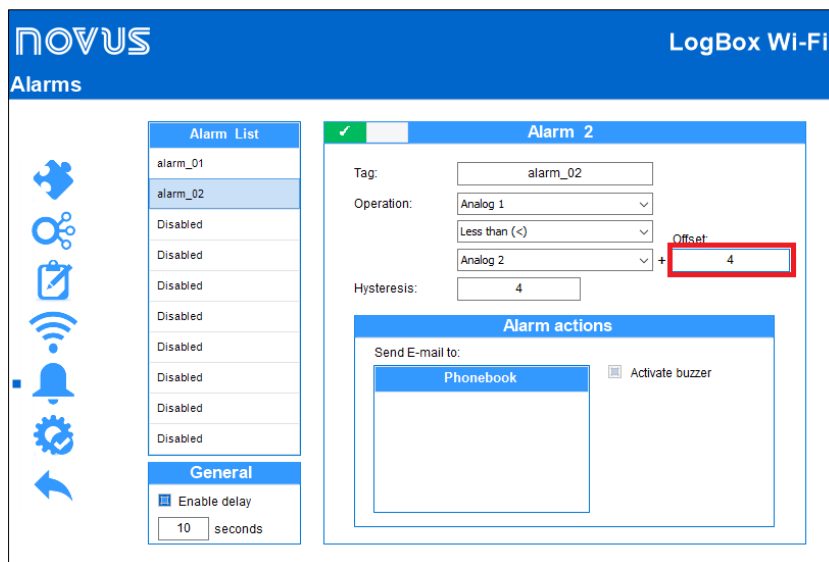

Figure 20 – Comparison between channels

You can create a comparison alarm between two channels. When selecting the operation and channels to be compared, you can add an offset value (corresponding to the parameter highlighted in red) to the second selected channel. Thus, the value of the first channel will be compared to the value of the second channel and the configured offset value.

13.4 DIAGNOSTICS

It is possible to view the **LogBox Wi-Fi** diagnostics tab by clicking the **Diagnostics** button located on the **NXperience** home screen. By clicking on it, the software will monitor some device states. The information update range is 1 second.

13.4.1 LOGS

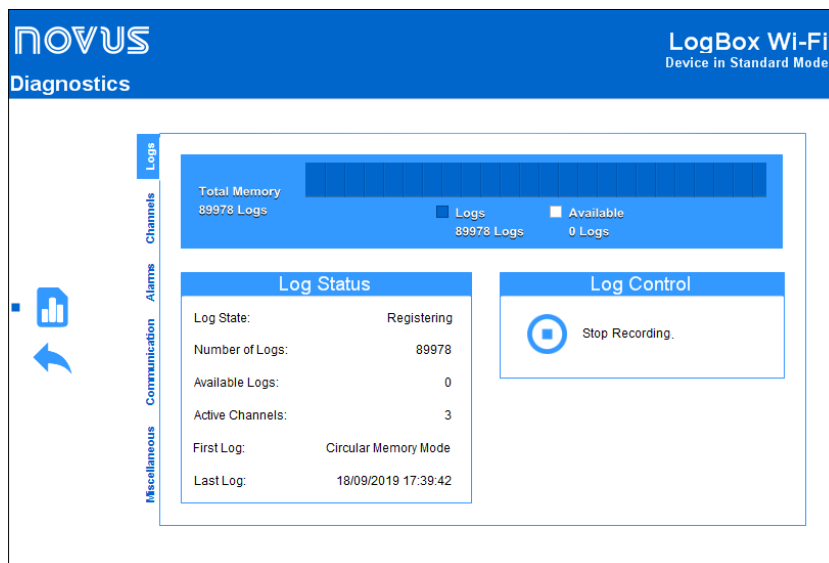

Figure 21 – Diagnostics Screen: Logs

- **Log Status:** Displays information about the log status, such as the number of recorded logs, the available memory, the number of active channels, and the date of the first and last log in the **LogBox Wi-Fi** memory.
- **Log Control:** Allows you to start or pause **LogBox Wi-Fi** data logging. For this option to be active, the "By Software" parameter must be enabled in start and/or end of log mode.

13.4.2 CHANNELS

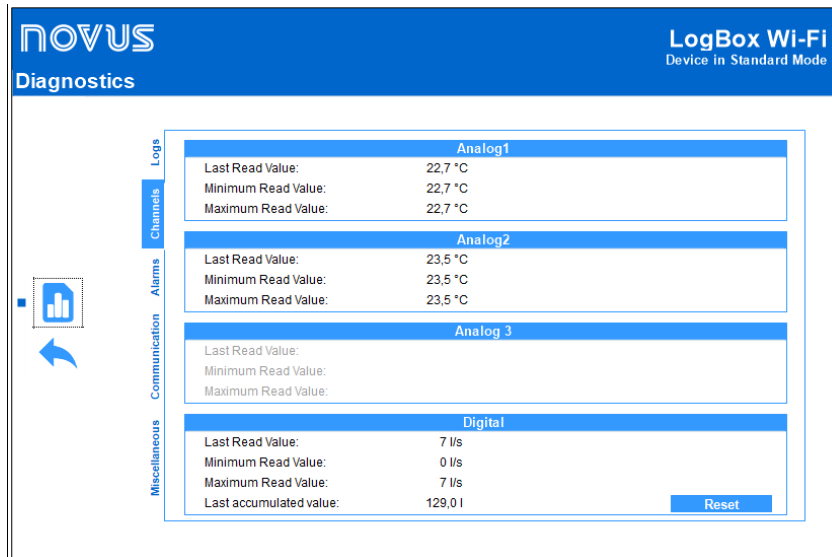

Figure 22 – Diagnostics Screen: Channels

- Analog Channels and Digital Channel:** Displays information about the acquisitions made by the device on the analog channel sensors and on the digital channel sensor.
 - Last Read Value:** Displays the value of the last acquisition performed by the device on the corresponding channel sensor. The displayed value may have been updated by a display update frequency and not logged in the memory.
 - Minimum Read Value:** Displays the minimum red value by the device on the corresponding channel sensor. The displayed value may have been read by a display update frequency and not logged in the memory.
 - Maximum Read Value:** Displays the maximum value read by the device on the corresponding channel sensor. The displayed value may have been read by a display update frequency and not logged in the memory.
 - Last Accumulated Value:** For the digital channel, it displays the last accumulated value by the device in Pulse Count mode. Clicking on the **Reset** button allows resetting the accumulator value and restarting the counting.

13.4.3 ALARMS

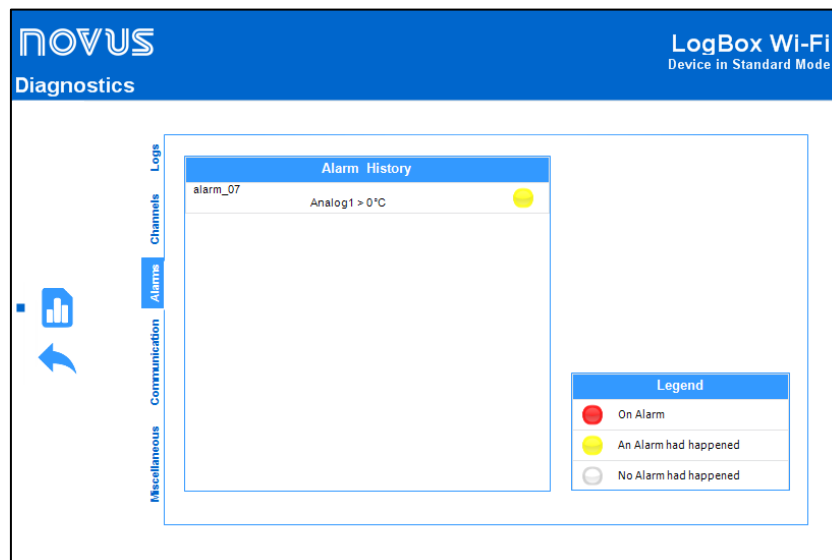

Figure 23 – Diagnostics Screen: Alarms

This tab provides information on the history of enabled and configured alarms for **LogBox Wi-Fi** (see [Alarms Configuration](#) section), its current condition, and a color legend that shows you if the configured alarms are currently in alarm, whether the configured alarm has already entered an alarm situation at some point, or whether the configured alarm has never entered an alarm situation.

13.4.4 COMMUNICATION

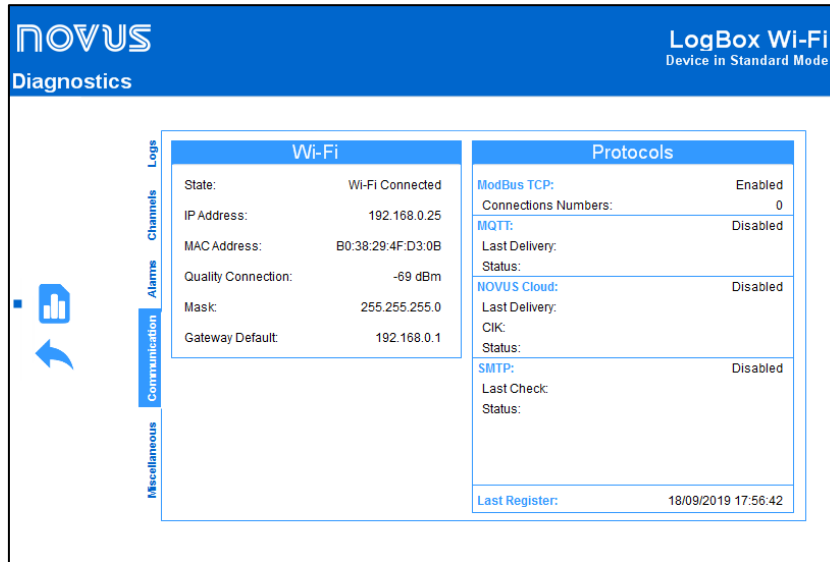

Figure 24 – Diagnostics Screen: Communication

- **Wi-Fi:** Displays information about the device's Wi-Fi connection.
 - **State:** Displays information about the device's current state.
 - **IP Address:** Displays information about the device's IP address.
 - **MAC Address:** Displays information about the device's MAC address.
 - **Quality Connection:** Displays information about the connection quality.
 - **Mask:** Displays information about the device's mask.
 - **Gateway Default:** Displays information about the device's gateway default.
- **Protocols:** Displays information about the device's protocols
 - **Modbus TCP:** Informs you whether the Modbus-TCP protocol is enabled or disabled and the number of currently active connections.
 - **MQTT:** Informs you whether the MQTT protocol is enabled or disabled and, if enabled, provides data about the last time information was sent and its status.
 - **NOVUS Cloud:** Informs you whether the sharing feature with **NOVUS Cloud** is enabled or disabled, and if enabled, provides information about the last data submission to the cloud and its status.
 - **SMTP:** Informs you whether the SMTP protocol is enabled or disabled and, if enabled, provides information about the last scan performed and its status.
 - **Last Register:** Informs you the date and time of the last log made by the device.

13.4.5 MISCELLANEOUS

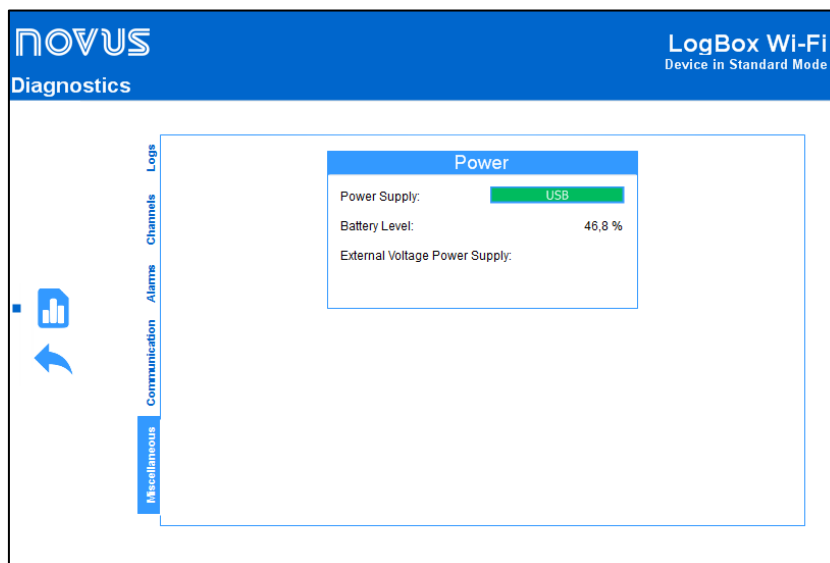

Figure 25 – Diagnostics Screen: Miscellaneous

- **Power:** Displays the device's power information.
 - **Power Supply:** Displays the current power supply of the device.
 - **Battery Level:** Displays the current battery level status. This information is updated in the logs frequency with a minimum frequency of 5 minutes.
 - **External Power Supply Voltage:** Displays the external power supply voltage of the device. This information is updated in the logs frequency with a minimum frequency of 5 minutes.

13.5 NXPERIENCE MOBILE SPECIFIC FEATURES

13.5.1 INSTALLING THE APPLICATION

To install the application, just look for **NXperience Mobile** in the Google Play Store or the App Store. After the download is finished, you should run the application.

If your smartphone has an Android version below 6.0 or an iOS version below 11, the application will not be available in the Google Play Store or the App Store.

NXperience Mobile uses the native iOS "Files" app to perform file management.

13.5.2 OPERATION OF THE APPLICATION

The communication of the application with **LogBox Wi-Fi** is done through the Wi-Fi interface of your smartphone, so it must be enabled on your device and your smartphone. The application uses the Modbus-TCP protocol to communicate with the **LogBox Wi-Fi**, so this protocol must also be enabled on the device. For the communication to succeed, your device and smartphone must be connected to the same Wi-Fi network.

For information about connecting the device to the Wi-Fi network and enabling the Modbus-TCP protocol, check the [Communication Parameters](#) section of this chapter. Connecting the **LogBox Wi-Fi** to the Wi-Fi network must be done through the **NXperience** software before any pairing attempt occurs between your smartphone and the device.

The initial screen of the Android application has four icons: **Configuration, Monitoring, Download** and **File Manager**. The iOS app home screen, on the other hand, has five icons: **Configuration, Monitoring, Downloading** and **File Manager**, which bring the main features of the application, and **Preferences**, whose icon is on the upper right side of the screen.

For the Android application to be used to configure and download the **LogBox Wi-Fi** device, you must click the Wi-Fi button . To use the iOS application, you must click on the button at the top of the screen .

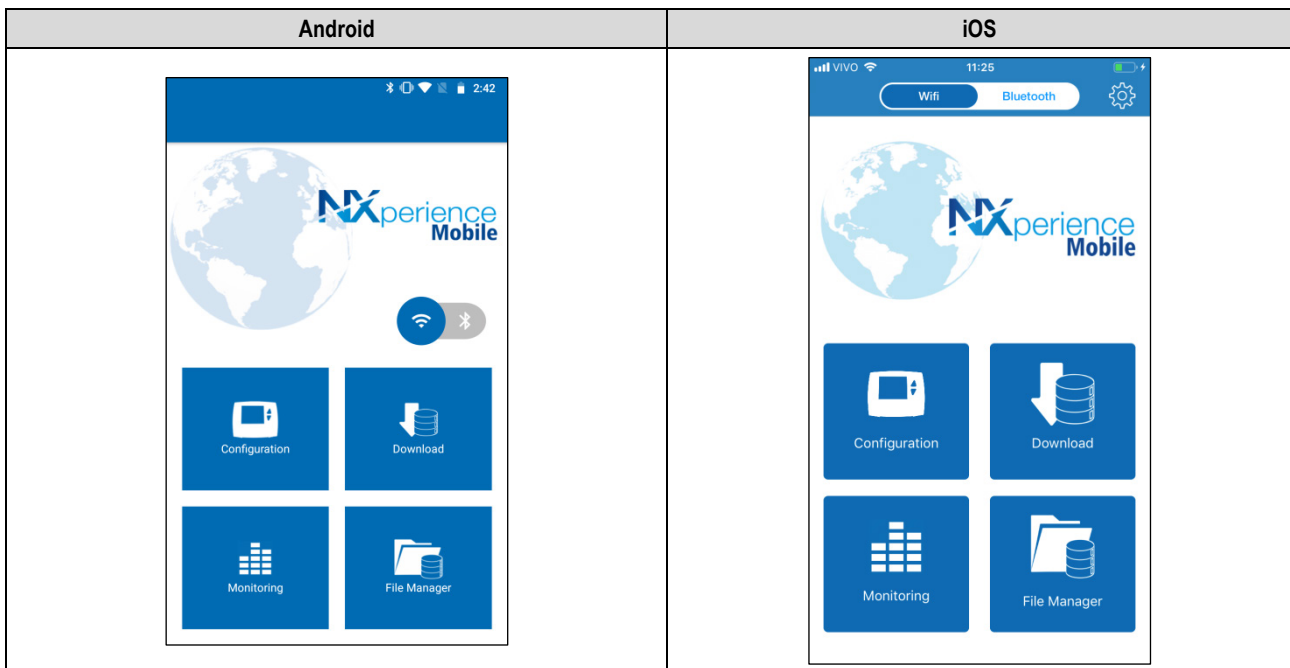

Figure 26 – Application home screen

13.5.3 DOWNLOAD LOGS

You can access this feature by selecting the **Download** option from the application's home menu.

Your device and smartphone must be pre-connected to the same Wi-Fi network to pair your smartphone with the **LogBox Wi-Fi**. After that, you must complete the connection data, as shown below:

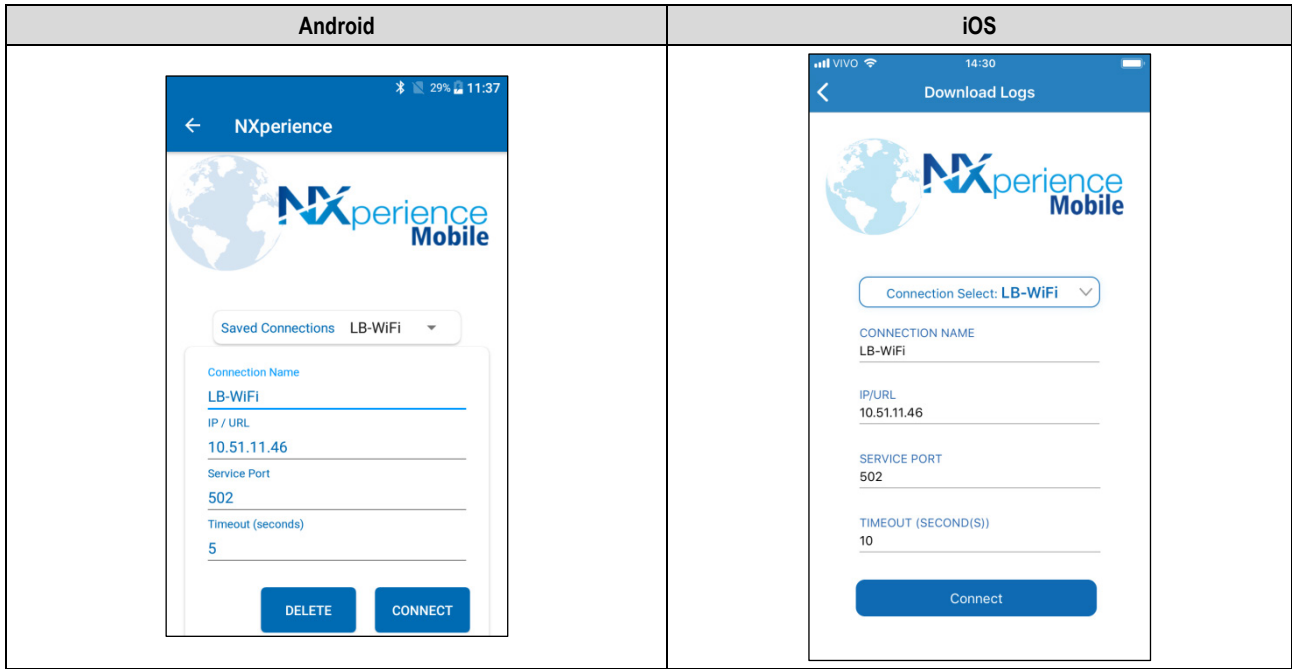

Figure 27 – Wi-Fi Connection

You can determine a specific name for each connection, which will be automatically saved and appear as an option in **Saved Connections**, by naming it in the **Connection Name** field.

To connect the application to the **LogBox Wi-Fi**, you must enter the IP address of the device and the service port number used (see [Navigation Screens](#) for information about the IP address of the device).

To delete a saved connection, simply select it in the **Saved Connections** field and click the  button.

Once the connection to the device is complete, a selection screen for the download period will be available.

The **Download from Date** parameter will be automatically filled by the application with the date/time of the first log. The **Download to Date** parameter will be filled with the most recent log date/time.

If there are logs in the chosen period, you can freely change the dates.

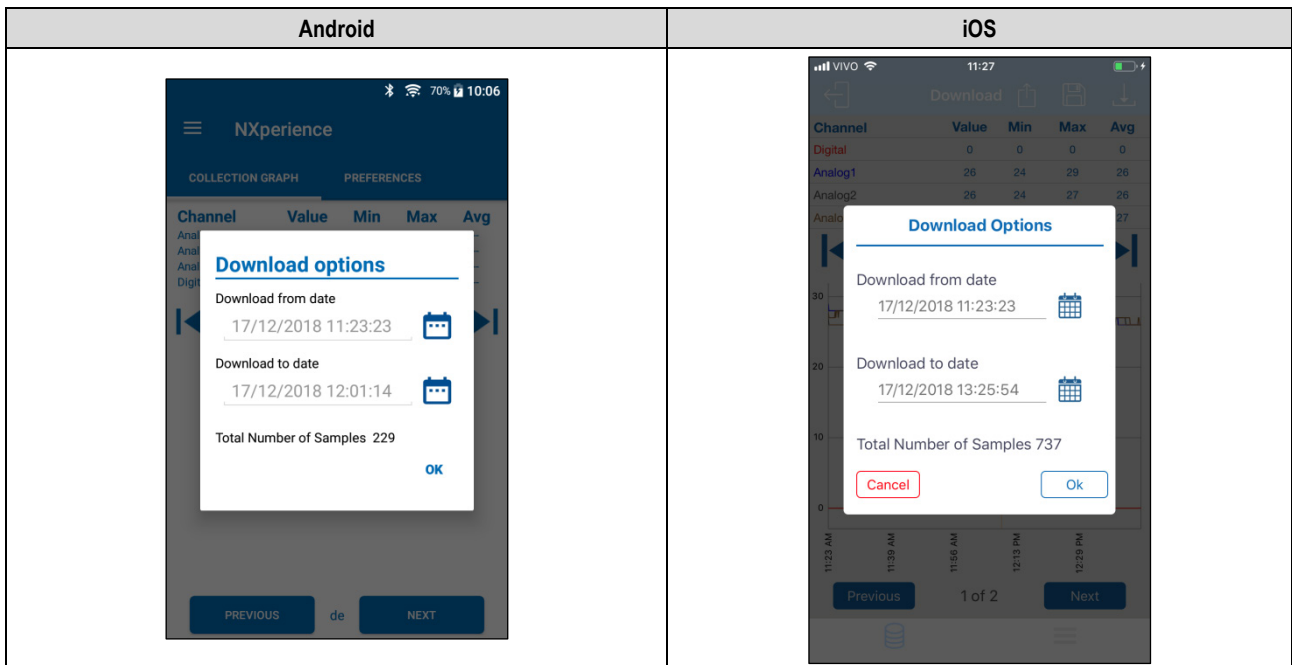

Figure 28 – Download options

The more logs downloaded, the longer the data download process takes and the greater the consumption of the device during download. This time depends on the quality of the Bluetooth connection between smartphone and **LogBox Wi-Fi**. For a satisfactory experience, it is suggested to divide a very large data download into two or more steps.

A typical download, smaller than 3000 logs, lasts around 60 seconds. A full memory download, however, can take more than 20 minutes to be completed. Both times of download duration depending on the Wi-Fi signal quality.

If the download is slow, it is recommended to bring the smartphone closer to the **LogBox Wi-Fi** that is being downloaded.

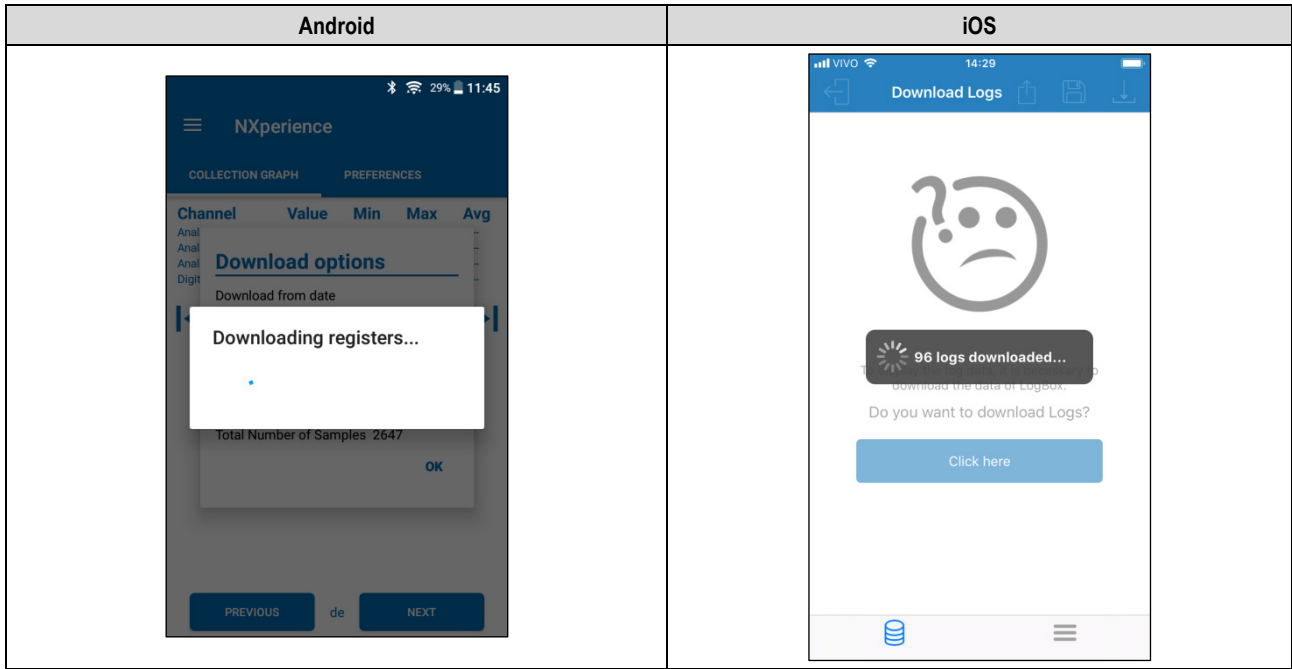

Figure 29 – Downloading logs

If **LogBox Wi-Fi** does not have logs, the application displays the message shown below:

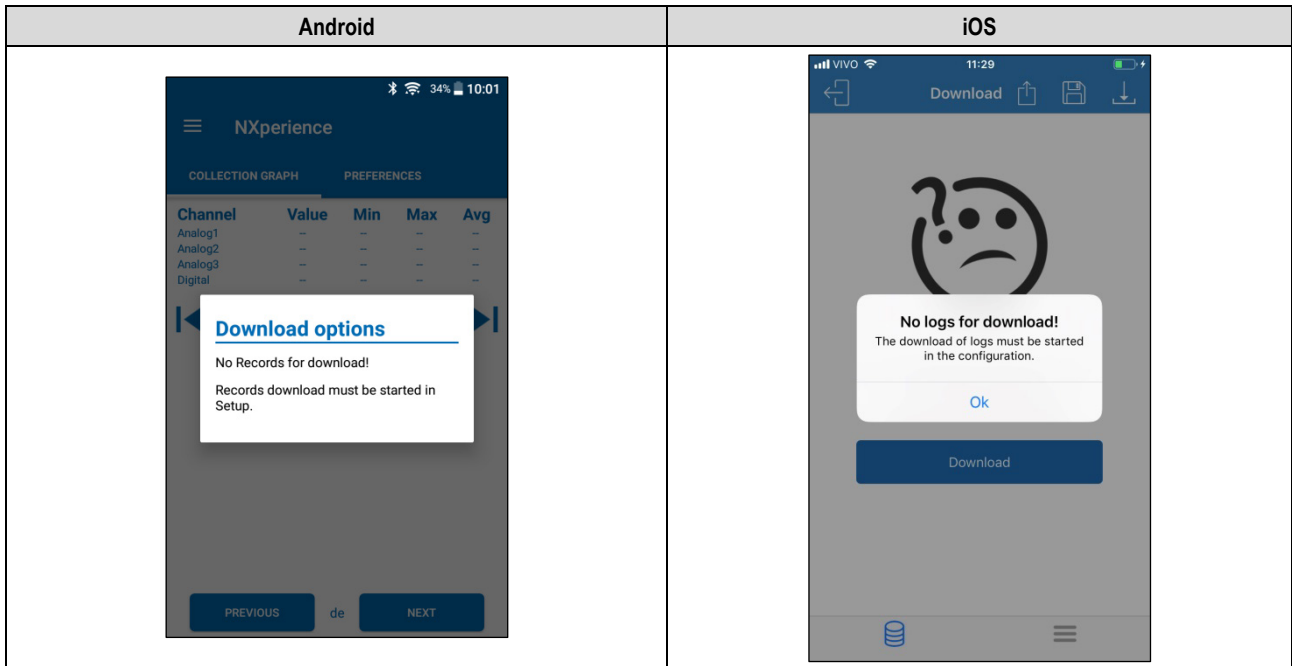

Figure 30 – LogBox Wi-Fi without logs

13.5.3.1 CHART

This screen allows you to view the data history at different time ranges and in a graphically way. It also shows the maximum value, the minimum value, and the average recorded value of each channel during the download period.

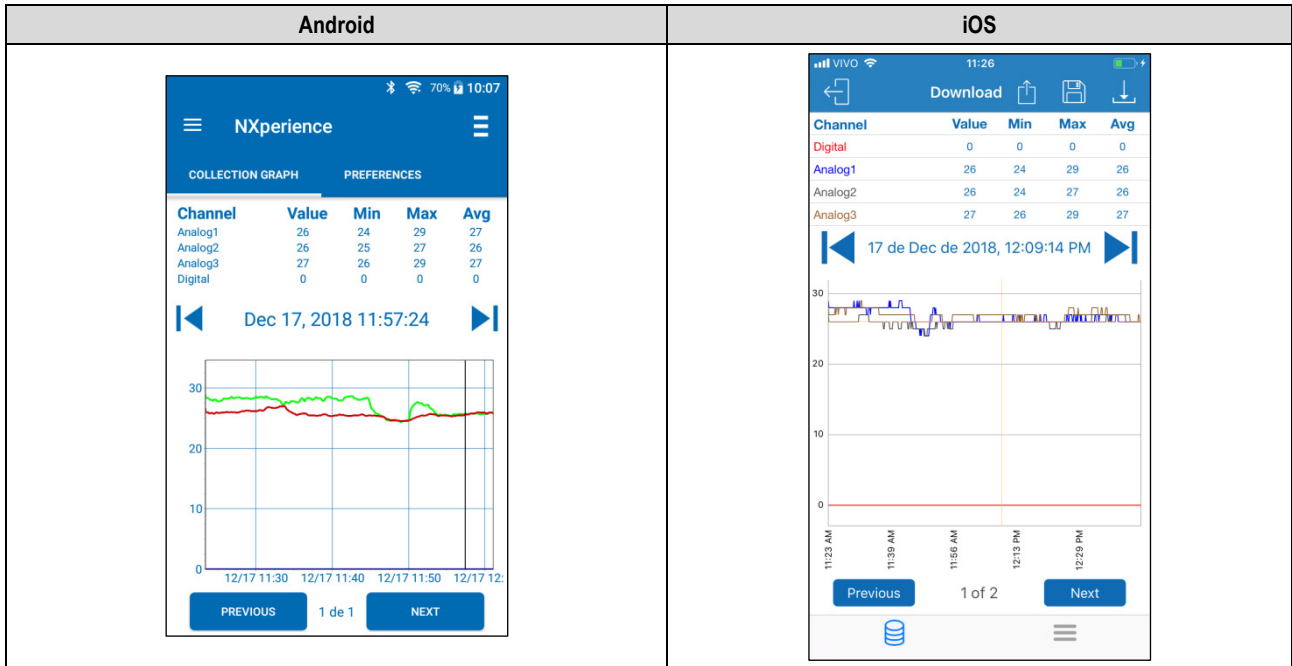

Figure 31 – Chart screen

Tapping on a point in the graph lets you see the value and time displayed at that point.

The number of logs displayed in the chart is limited to allow better viewing on your smartphone. Each screen displays 500 acquisitions. To navigate the chart and view the other logs, you must use the and arrows. They will allow you to roll back or advance through 500 acquisitions.

13.5.3.2 LOG SCREEN OPTION MENU

For the Android application, pressing the icon in the upper right corner of the screen will show the options shown and described in figure below. For the iOS application, as you can see, the icons for **Download**, **Save Files** and **Share** will automatically appear.

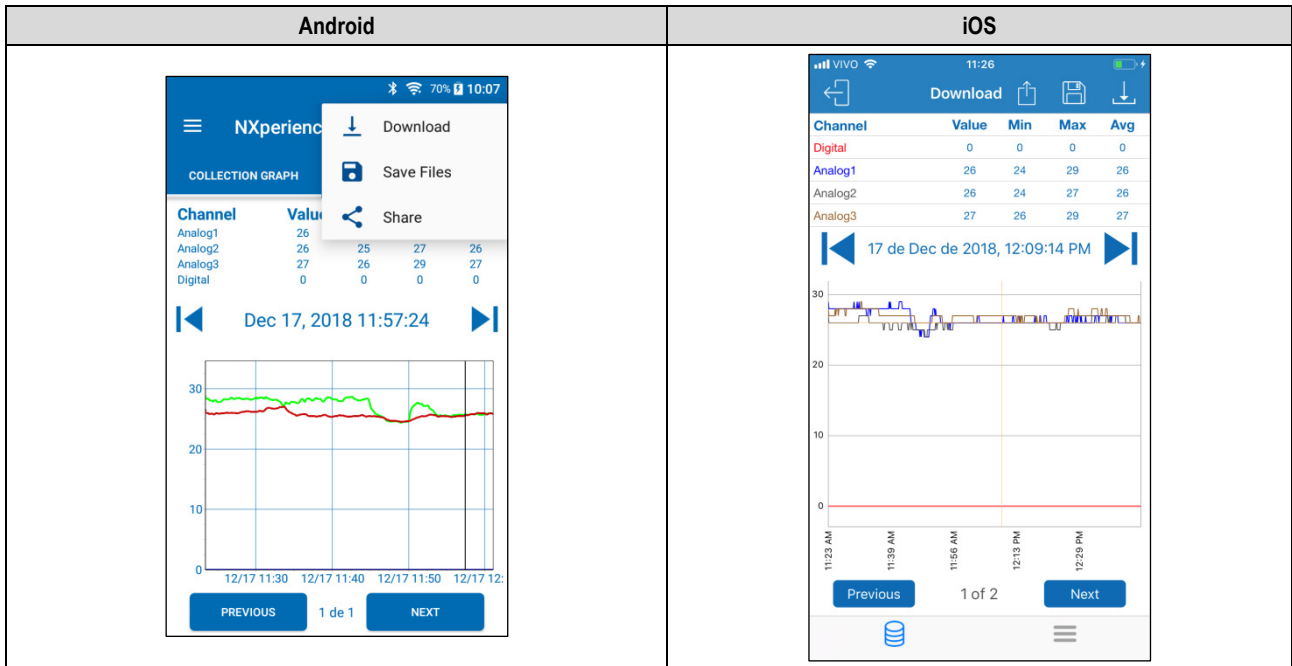

Figure 32 – Log screen option

Download: By pressing the icon, the user can perform a new data download. Thus, the previously performed download will be discarded, updating the event and graphic screens, which will always display information from the last download made.

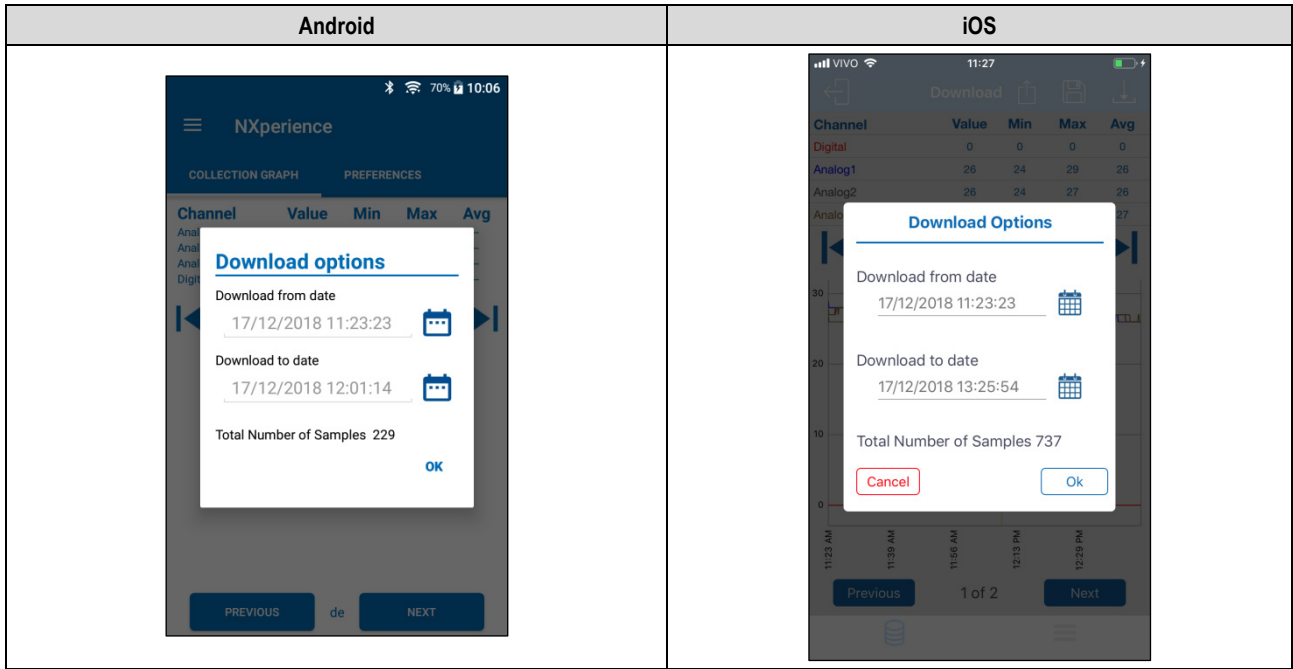



Figure 33 – Download logs

Save Files: By pressing the  icon, the user can save the downloaded files in the smartphone memory. The application will send a message informing that the files have been saved.

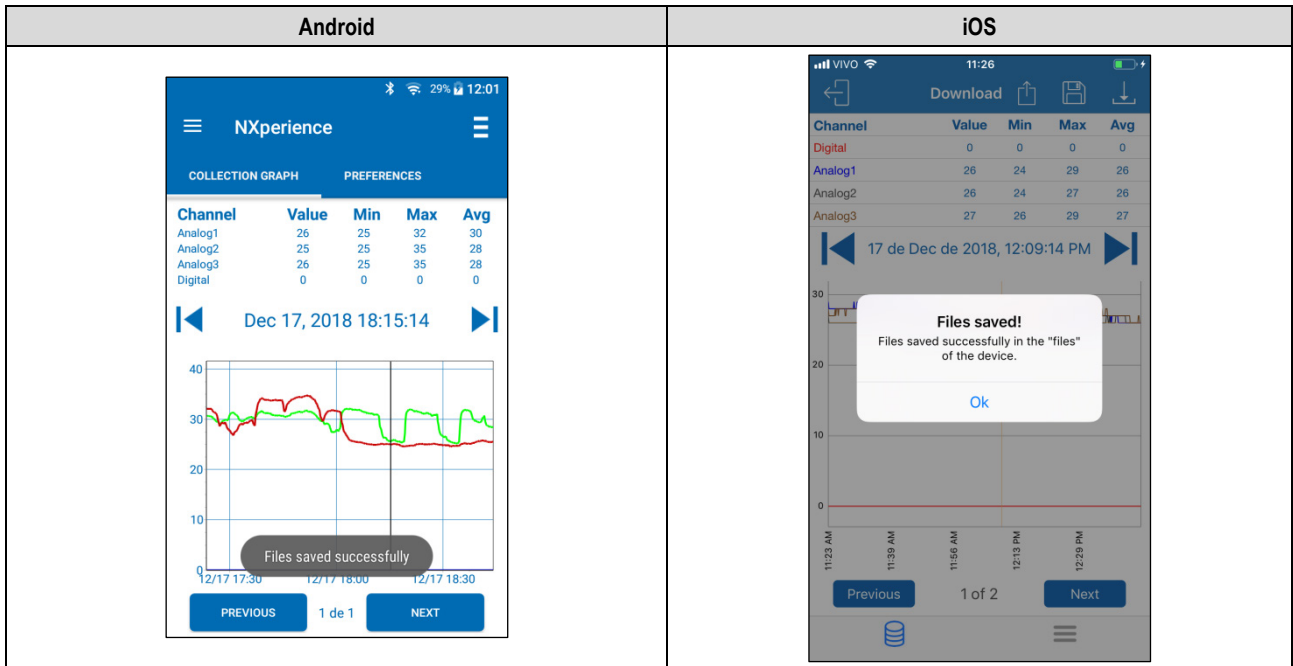



Figure 34 – Files saved successfully

Share: By pressing the  icon, the user can share the downloaded data using sharing applications already installed on the smartphone.

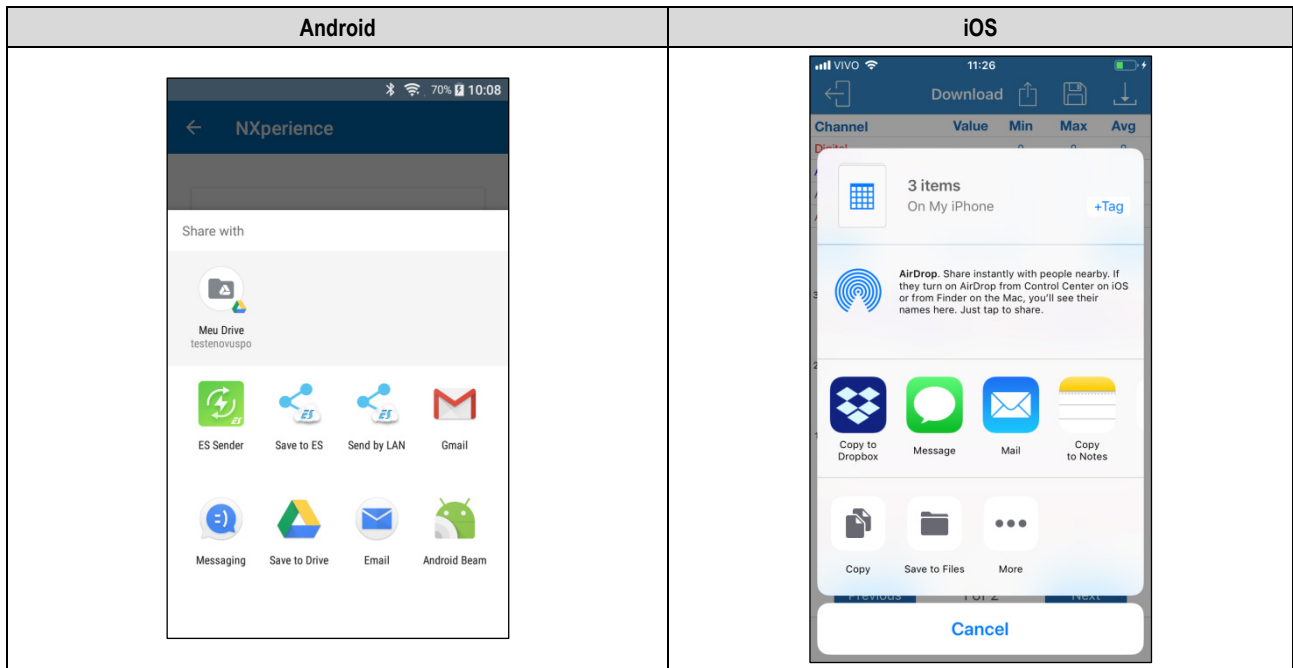



Figure 35 – Data sharing screen

The files that will be downloaded, saved, and shared will obey the **Default Sharing Options** on **Preferences** screen (see [Preferences](#) topic).

13.5.3.3 SHORTCUTS MENU

Clicking the  icon on the Android application, positioned on the upper left side of the application, opens a shortcut tab, which can redirect the application to the file manager or to the home screen and allow you to show the application version.

Clicking the  icon on the iOS application, positioned at the bottom of the application, opens a shortcut tab, which can redirect the application to the file manager, the preferences menu, the password configurations, and other options.

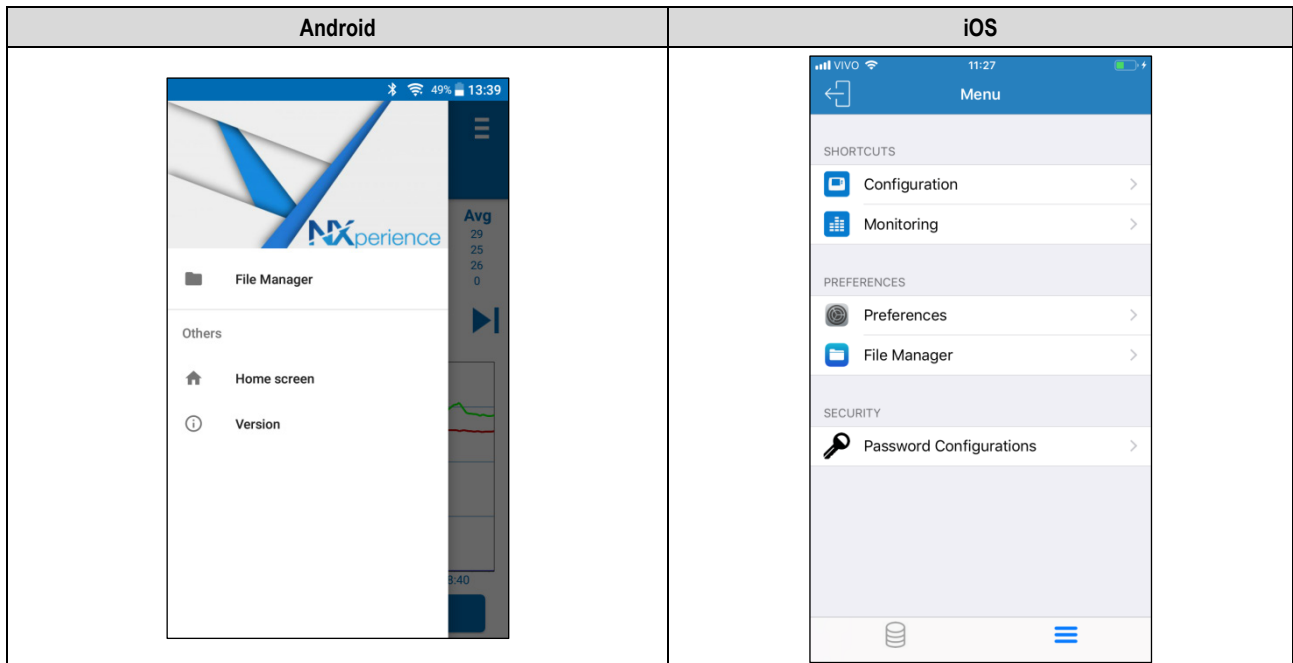

Figure 36 – Shortcuts menu

13.5.3.4 PREFERENCES

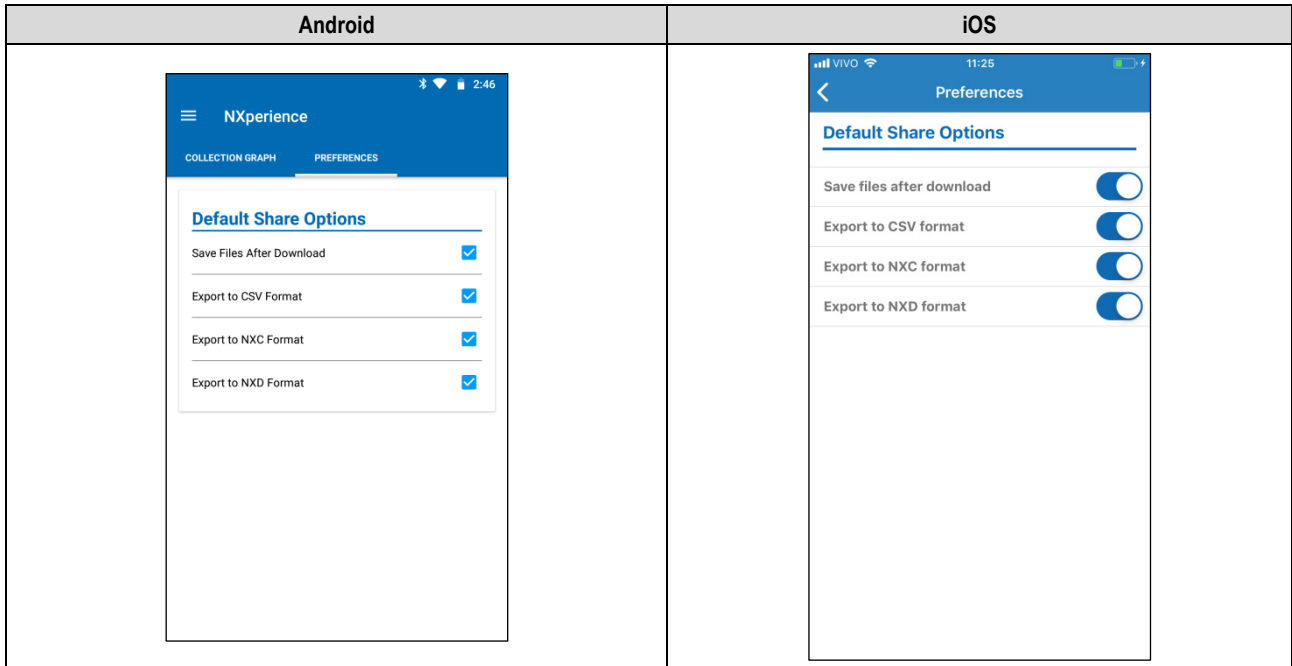

Figure 37 – Preferences

- **Default Share Options:** The user can configure how they want to share the data downloaded from **LogBox Wi-Fi** and managed by **NXperience Mobile**.
 - **Save Files after Download:** Configures the application to save the downloaded files in the smartphone internal memory.
 - **Export to CSV format:** Configures the application to share a .csv extension file with all the logs from last download. This file can be opened by using *Microsoft Office Excel*.
 - **Export to NXC format:** Configures the application to share a file with **LogBox Wi-Fi** configuration in a format compatible with **NXperience** (.nxc).
 - **Export to NXD format:** Configures the application to share a file with the downloaded data in a format compatible with **NXperience** (.nxd).

13.5.1 MONITORING

The **Monitoring** section provides information about the values downloaded by the device.

13.5.4.1 MONITORING

This screen provides information about the active channels, informing the current value and the maximum and minimum values downloaded by each channel.

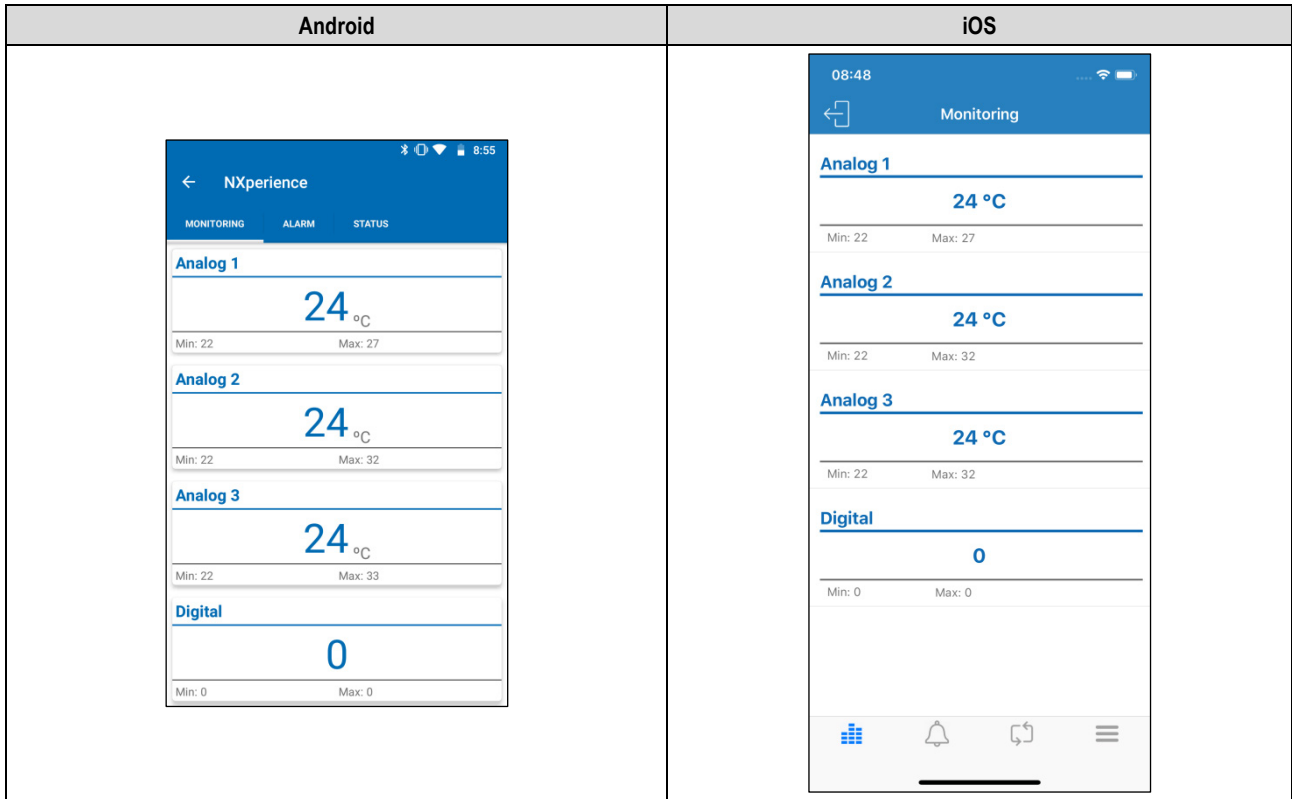

Figure 38 – Monitoring

13.5.4.2 ANDROID NOTIFICATIONS

Functionality available only for the Android application, the device will display notifications to report alarms that are in an alarm situation and about the time and conditions in which they occurred when the application is in the background.

Alarm Notifications	End of Alarm Notifications
<p>now ▾ alarm_02 Analog1 > Analog2 At 14:12:13</p>	<p>now ▾ alarm_02 End of alarm Analog1 > Analog2 At 11:23:13</p>

Table 16 – Alarm Notifications

13.5.4.3 ALARMS

This screen provides information about alarms (configured in the **NXperience Alarms Configuration** section) that are in an alarm situation. Each alarm on this screen displays the channels to be compared, the previously selected operation, and the Offset, Range or Hysteresis values set for each one.

For more information on the function of each operation and the specific parameters of each channel, just check the [Alarms](#) chapter of this manual. If there is no alarm situation, the message "No alarms" will be displayed.



Figure 39 – Alarm monitoring

13.5.4.4 STATUS

This screen displays the same information about the device, such as the status of the logs, the number of logs available, the serial number of the device, the firmware version of the device, etc.

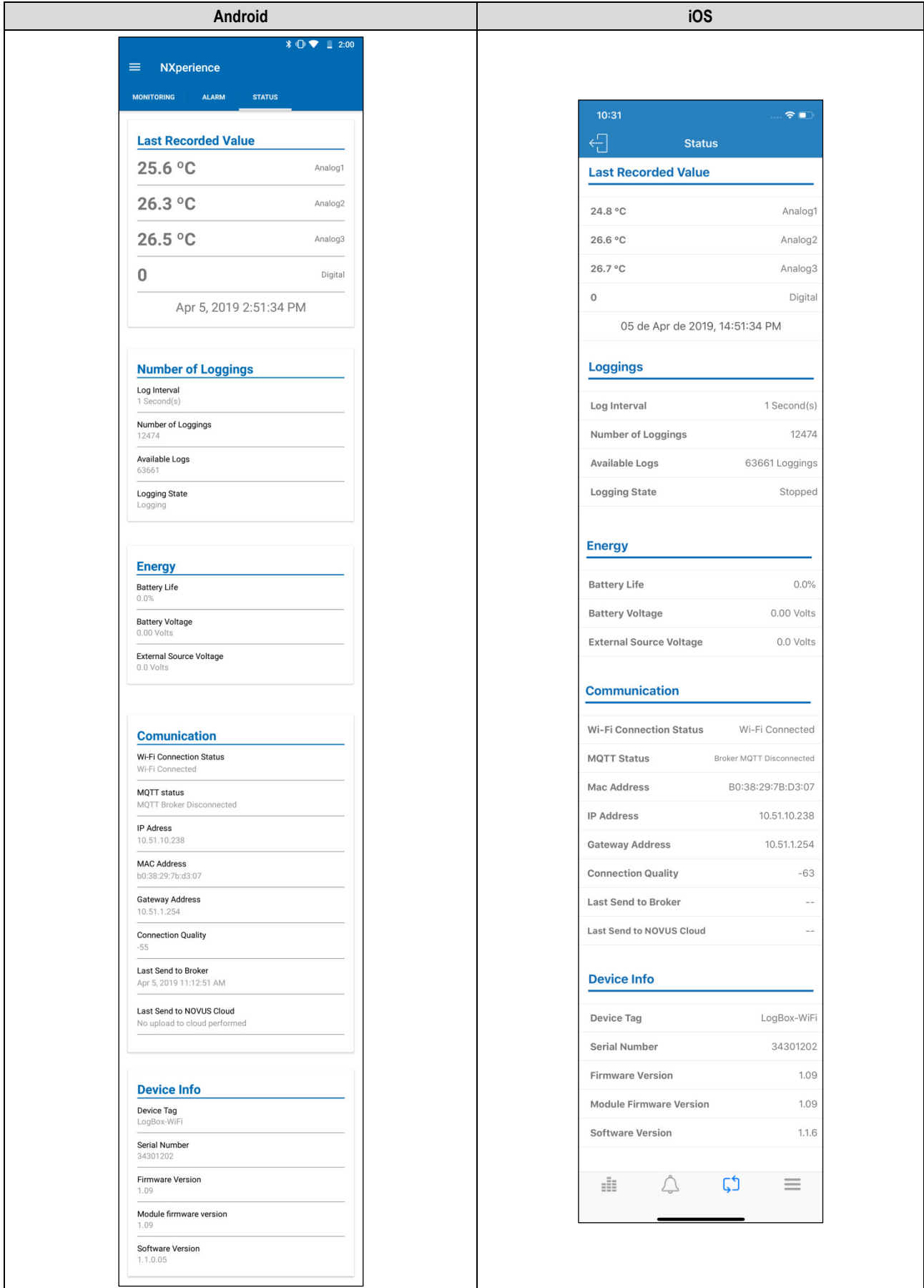

Figure 40 – Status

- **Last Recorded Value:** Displays the value of the last acquisition made by the LogBox Wi-Fi for each channel. The last acquisition may not have been recorded in memory.

- **Number of Loggings:** Displays basic information about **LogBox Wi-Fi** logs.
 - **Log interval:** Displays the value of the configured range of logs.
 - **Number of Loggings:** Displays the number of logs made by the LogBox Wi-Fi.
 - **Available Logs:** Displays the available number of logs.
 - **Logging State:** Reports whether the device is registering or is stopped.
- **Energy:** Displays information about the possible power supplies of the **LogBox Wi-Fi**.
 - **Battery Life:** Displays the remaining percentage of the battery.
 - **Battery Voltage:** Displays the battery voltage in Volts.
 - **External Source Voltage:** Displays external power supply voltage in Volts.
- **Communication:** Displays the settings about the device's Wi-Fi communication.
 - **Wi-Fi Connection Status:** Displays the status of the Wi-Fi communication. Because Wi-Fi needs to be enabled, the status will always be enabled to be able to read information through the application.
 - **MQTT Status:** Displays the status of the MQTT.
 - **IP Address:** Displays the IP address of the device.
 - **MAC Address:** Displays the MAC address of the device.
 - **Gateway Address:** Displays the Gateway address of the device.
 - **Connection Quality:** Displays, in dBm, the signal strength of the connected device (this value is obtained on the initial screen at the time of the search, i.e., this value is not updated periodically).
 - **Last Send to Broker:** Displays information about the last shipment made to the Broker.
 - **Last Send to NOVUS Cloud:** Displays information about the last shipment made to the NOVUS Cloud.
- **Device Information:** Displays specific **Wi-Fi LogBox** information.
 - **Device Tag:** Displays the name configured by the user.
 - **Serial Number:** Displays the factory-preset serial number.
 - **Firmware Version:** Displays the firmware version of the device.
 - **Module Firmware Version:** Displays the firmware version of the Wi-Fi module.
 - **Software Version:** Displays the version of the application.

13.5.2 FILE MANAGER

This screen allows you to erase and share data from previously performed downloads. It displays a list containing all downloads performed and saved by the user, separated by the downloaded **LogBox Wi-Fi** serial numbers. In this list you can select the desired files and share or delete them.

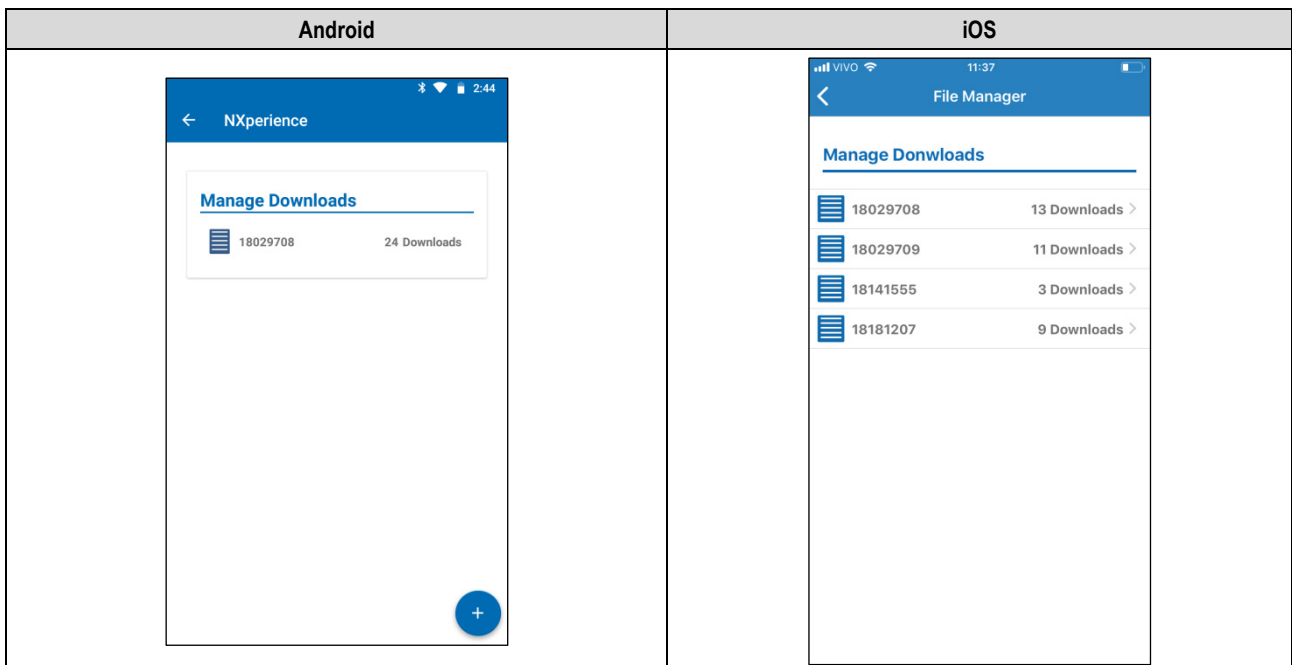

Figure 41 – File Manager screen

By clicking on the desired **LogBox Wi-Fi**, identified by the serial number, **NXperience Mobile** will expand a list containing all saved downloads from that device.

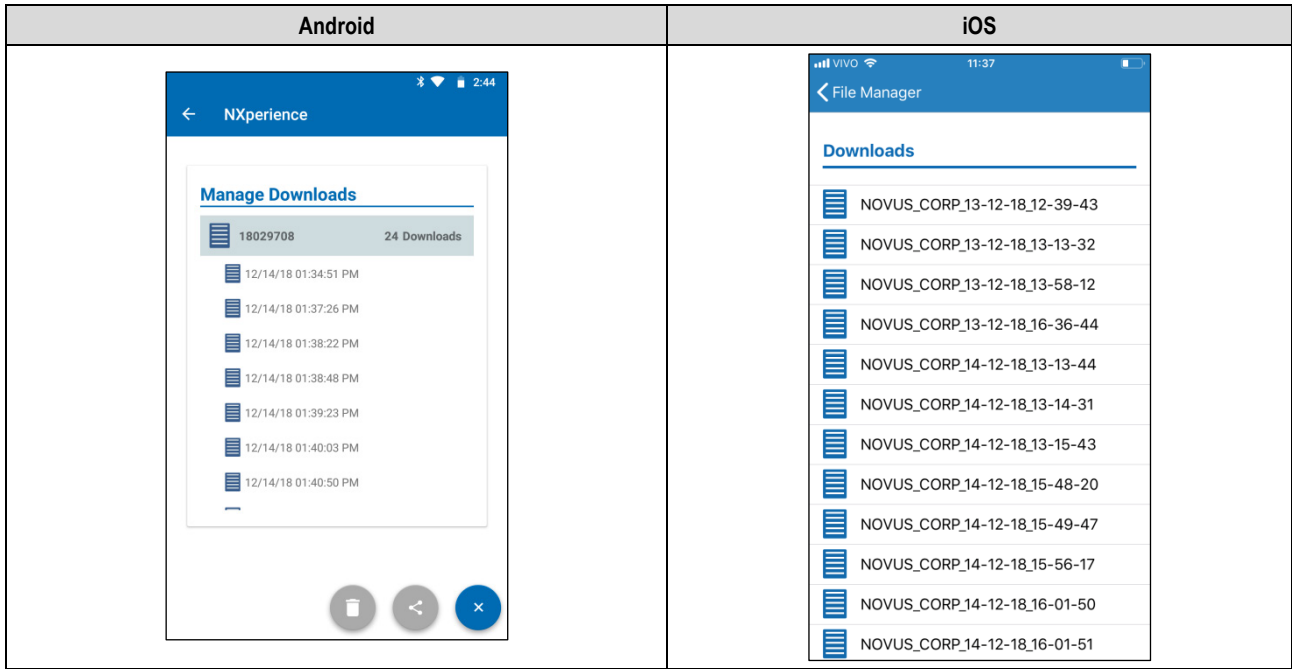

Figure 42 – Downloaded files

For the Android application, once a downloaded data is selected, the button  will change to . For the iOS application, pressing the desired downloaded data and dragging the finger to the left will display the icon . By clicking on it, you can expand the sharing option.

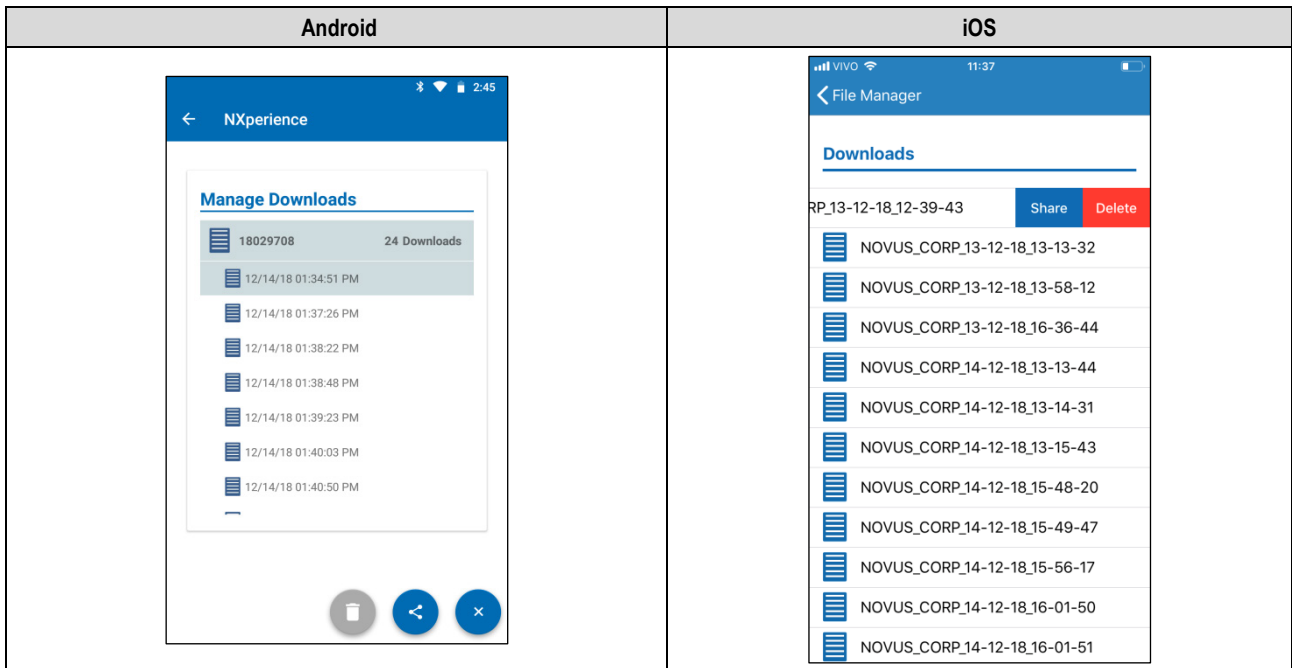



Figure 43 – Data selection

Pressing the  button or the  button will expand the sharing option, allowing you to select by which method you want to share the selected data.

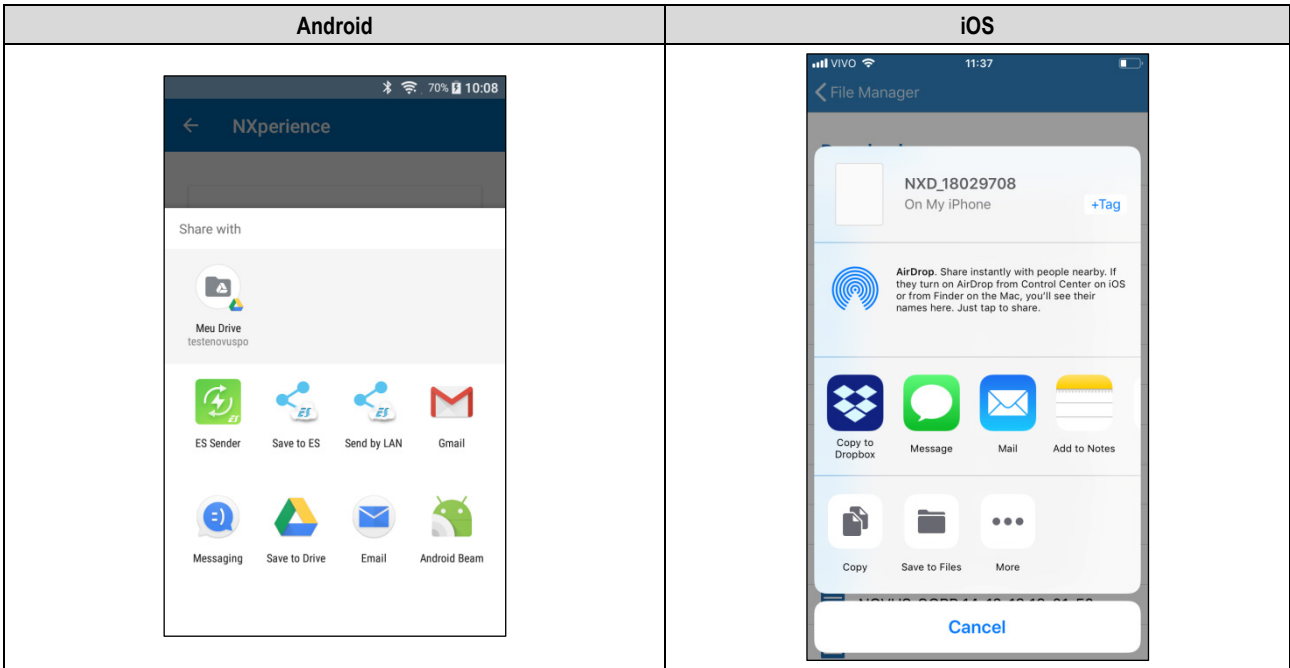



Figure 44 – Sharing data

For the Android application, to delete the selected item from the list, simply press and hold (long click) to open a *checkbox* to select the downloaded file you want to delete. Once this is done, simply press the  button to delete the selected data.

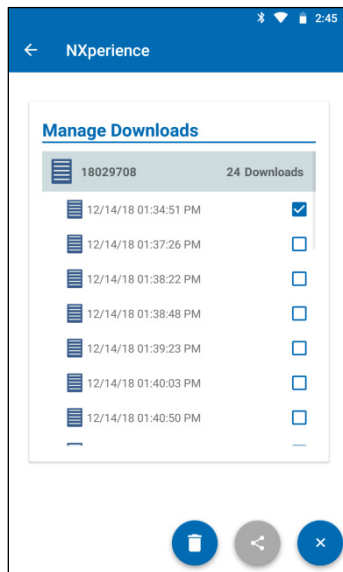

Figure 45 – Manage downloads

For the Android application, to delete all device data, you must press the serial number of the device whose data you want to delete from your smartphone memory and wait for the delete confirmation dialog box to appear.

For the iOS application, simply click on the serial number of the device whose data you wish to delete from your smartphone's memory and drag the data to the left. This move will display the **Delete** button, which will allow you to delete the selected download.

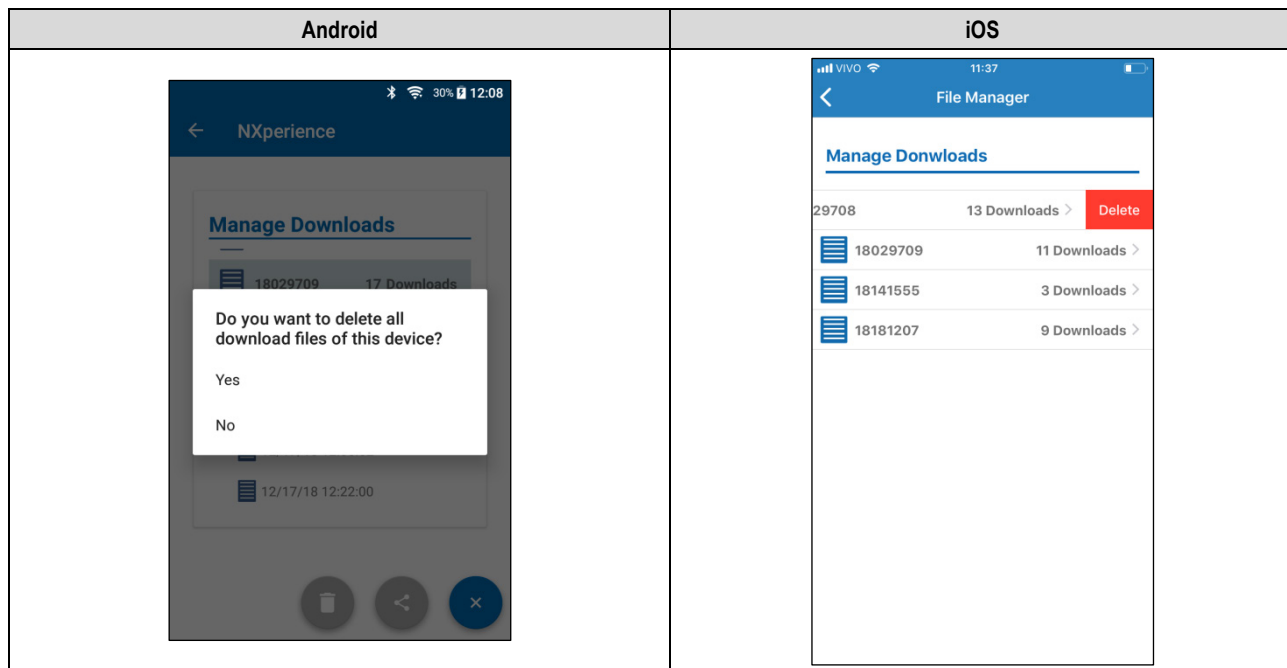

Figure 46 – Delete confirmation

14. INSTALLATION

14.1 MECHANICAL INSTALLATION

LogBox Wi-Fi has a high-quality casing, built in ABS + PC and with IP40 protection index.

To streamline the **LogBox Wi-Fi** attachment, the device comes with a fixing bracket, indicated, and developed for any type of wall, which has three oblong holes, arranged in a triangle, made to fix it using screws. Optionally, to facilitate the fixation on metal surfaces, it is possible to purchase the device model that comes with a fixing bracket with magnetic inserts.

To assist in the installation aesthetics, two openings in the lower part of the fixing bracket can be used to pass the sensors that are connected to the device. In addition to that, this bracket has a ring that allows the placement of a padlock preventing **LogBox Wi-Fi** from being removed from the installation location.

With the help of two screwdrivers and through two lateral fittings, it is possible to fix or remove the **LogBox Wi-Fi** from the bracket.

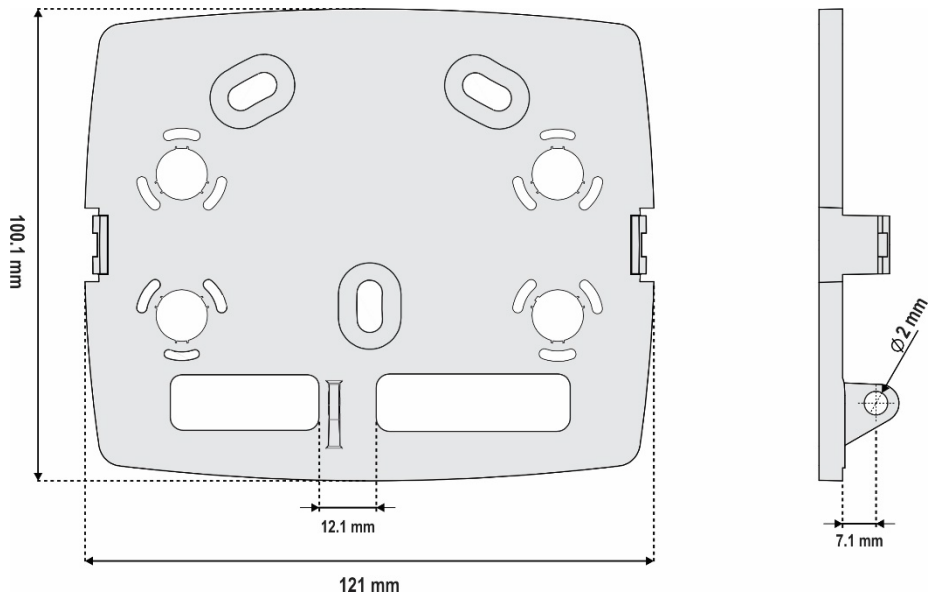

Figure 47 – Mounting bracket

To improve the device installation aesthetics, the **LogBox Wi-Fi** comes with a protection cover for the connections, which is lockable in the bottom of the device and that hides its sensors. This protection cover has four detachable cavities to facilitate sensor installation.

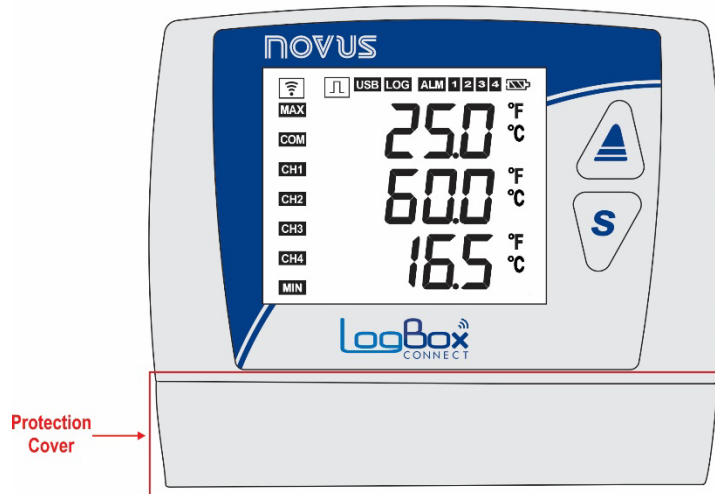

Figure 48 – Connections' Protection Cover

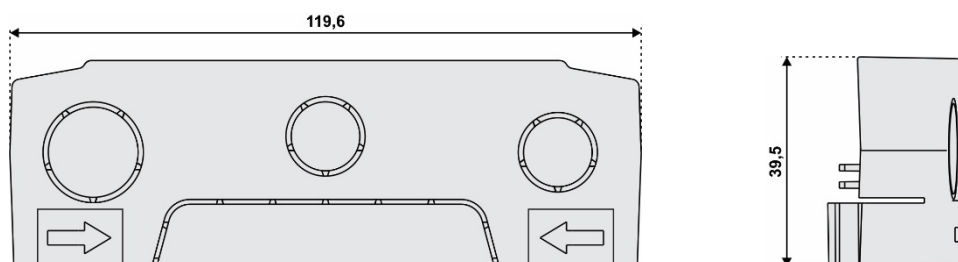

Figure 49 – Dimensions of protection cover detachable connections and cavities

To detach the protection cover, you must press the sides, one side at a time.

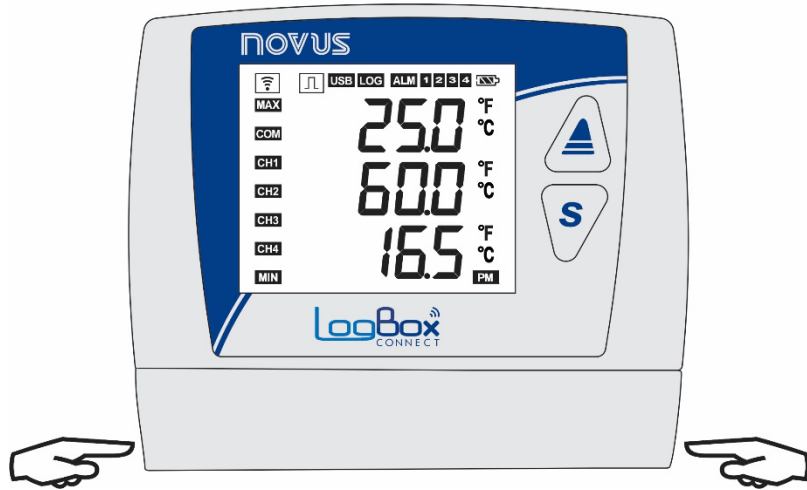

Figure 50 – Removing the protection cover

To attach the protection cover, it is necessary to press the area designated by the arrows and push one side at a time from the outside.

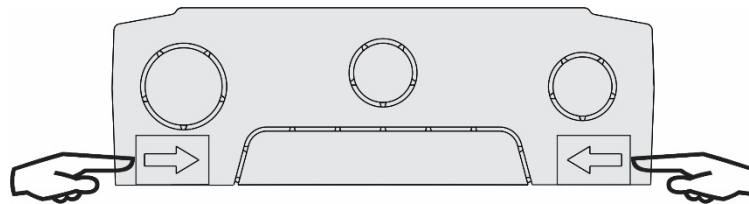

Figure 51 – Fitting the protection cover

14.1.1 DIMENSIONS

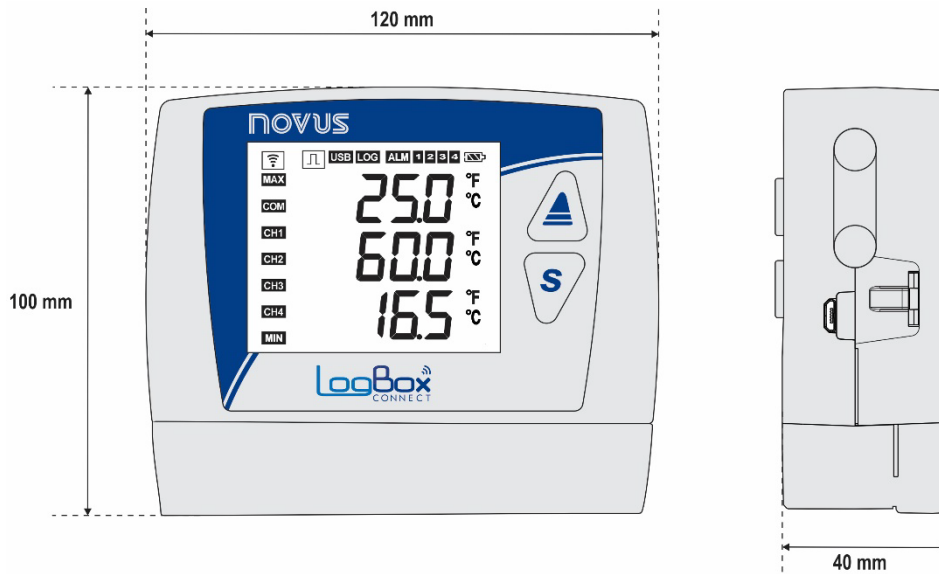

Figure 52 – LogBox Wi-Fi dimensions

To open the battery compartment, press the cover in the arrows region and push it in from the inside out.

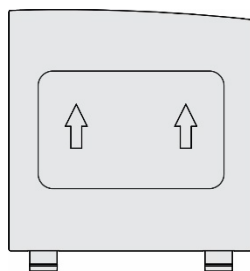

Figure 53 – Batteries cover

14.2 ELECTRICAL INSTALLATION

14.2.1 INSTALLATION RECOMMENDATIONS

- Electronic and analog signal drivers must run the plant separately from the output and power supply conductors. If possible, in grounded conduits.
- The power supply for electronic instruments must come from an appropriate grid for instruments.
- RC FILTERS (noise suppressors) are recommended in contactor coils, solenoids, etc.
- In control applications, it is essential to consider what could happen when some part of the system fails. The device's internal devices do not ensure total protection.
- The electrical connection terminal blocks must be made with the device's marked connection terminals. Before connecting them, make sure that the connections have been made correctly.
- Remember to wrap all wires inside the desired openings, designed for their passage, before making any electrical connections.
- If you use thermocouple type sensors and want to use grounded thermocouples, you must take care that the installation does not generate ground loops that could influence the correct temperature measurement by the device. This could generate false offsets, reading oscillation, possibly malfunction or even burn the device. The power supply input for the **LogBox Wi-Fi** analog sensors does not have galvanic isolation. Thus, grounded sensors on application equipment may create ground loops and influence the measurement. Use insulated thermocouples or, if grounded thermocouples are required, choose a power supply that provides good galvanic isolation to the device. You can also avoid ground loops by powering the device from the battery only, with no USB or external source.

14.2.2 SPECIAL PRECAUTION

By being an electronic module, **LogBox Wi-Fi** needs some care when handling:

- When opening the cover that provides access to the connector for battery replacement, due to the risk of damage caused by static electricity, avoid contact of the connection terminal blocks with them and with the electronic circuit.
- The device should not be opened due to the risk of damage caused by static electricity when the device has its electronic circuit exposed.
- Pay close attention to the sensor wires, the digital input, the digital output, and the external source connections.

14.2.3 ELECTRICAL CONNECTIONS

LogBox Wi-Fi has 4 detachable connection terminal blocks for connection of external power supply, digital output load, digital input sensor, and analog sensors for each of the 3 available analog channels. Figure below illustrates electrical connections in a basic way:

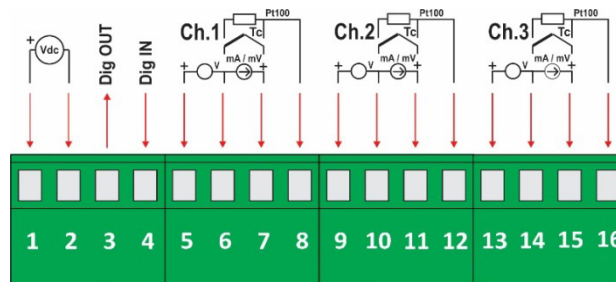

Figure 54 – Electrical connections

For the sensors connection, it is recommended that the connection terminal blocks be previously detached from the device. To streamline the sensors connection, it is necessary to use the enumeration printed on the connectors and the Electrical Connections image in the figure above, and in the Connections' Protection Cover.



The power supply, digital output, digital input, and analog inputs terminals are not isolated from each other! Therefore, analog, and digital signals from the same voltage source must not be used, otherwise the device will malfunction.

14.2.3.1 POWER SUPPLY

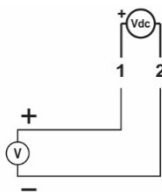

The connection to the Power Supply is made at the terminals according to the following image. The power supply used must be of the direct current type, with a voltage between 10 and 30 V and provide a minimum current of 15 mA when no load is connected to the digital output. If the load is connected to the digital output, the source used must be able to provide current compatible with the load used.

14.2.3.2 DIGITAL OUTPUT

Alarm Status Mode Connection

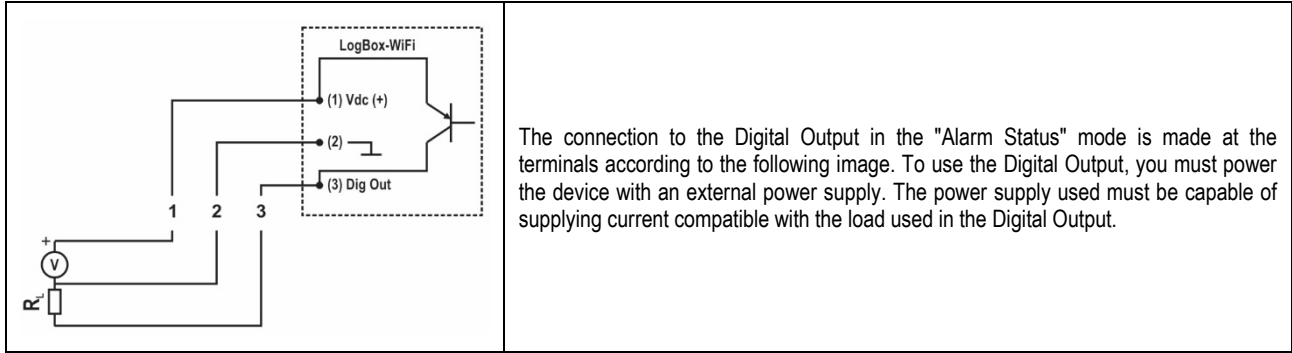

Connection in "Auxiliary Electronic Switch" Mode

The connection to the Digital Output in the "Auxiliary Electronic Switch" mode, used to power current transmitters, is made at the terminals according to the figure on the side. To use the Digital Output, you must power the device with an external power supply. The source used must be able to provide current compatible with the number of transmitters used.

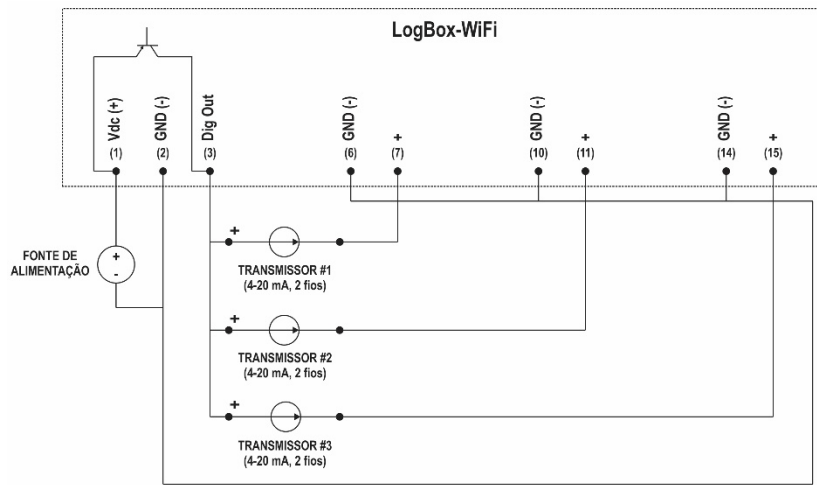
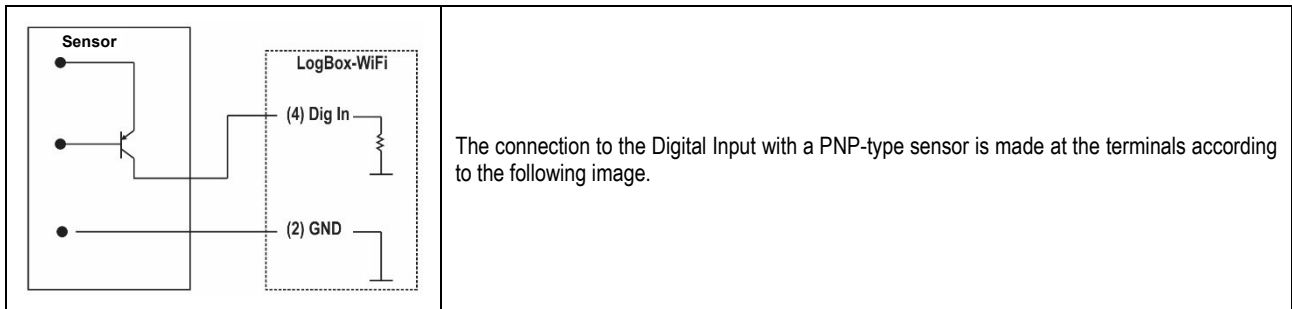

Figure 55 – Connection in "Auxiliary Electronic Switch" Mode

14.2.3.3 DIGITAL INPUT

PNP Connection



NPN Connection

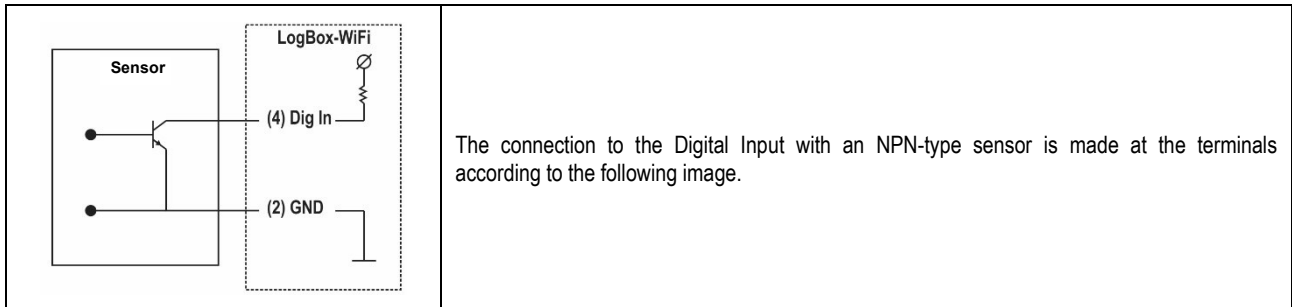

Dry Contact Connection

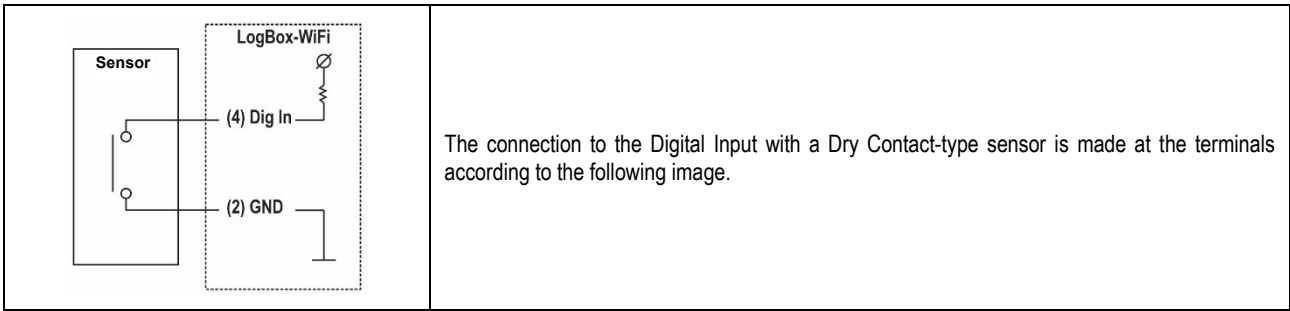

14.2.3.4 ANALOG INPUTS

Pt100 Connection

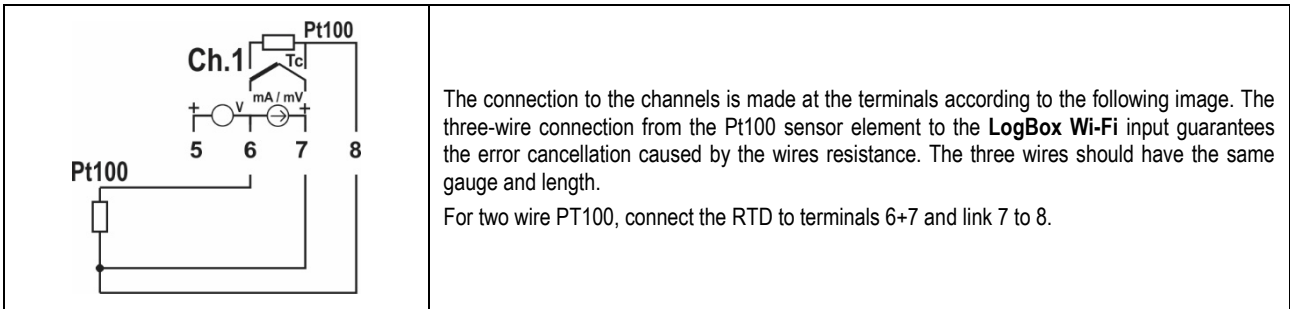

Thermocouples Connection

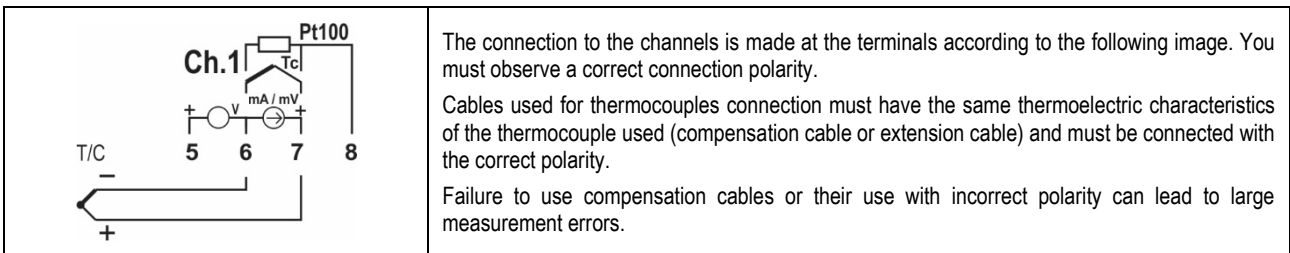

Voltage Connection (mV)

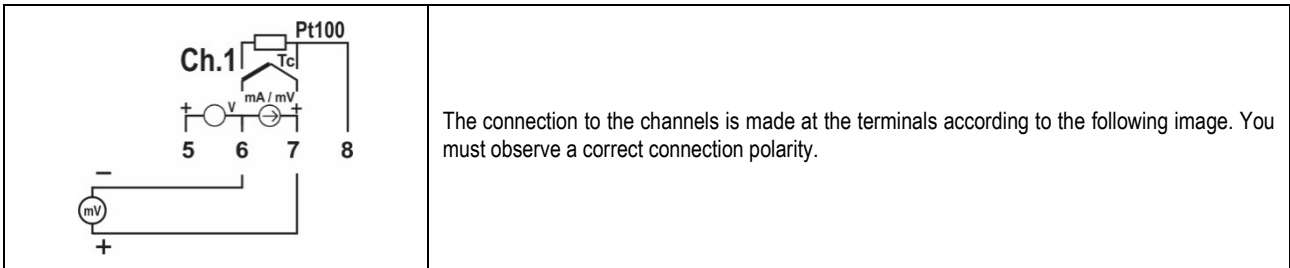

Current Connection (mA)

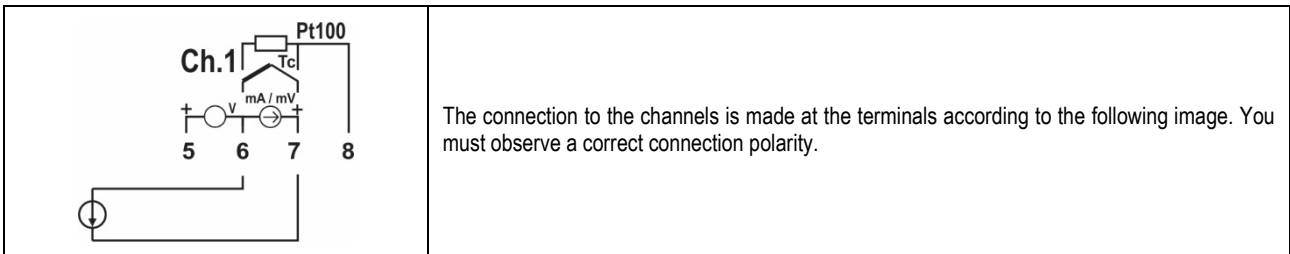

Voltage Connection (V)

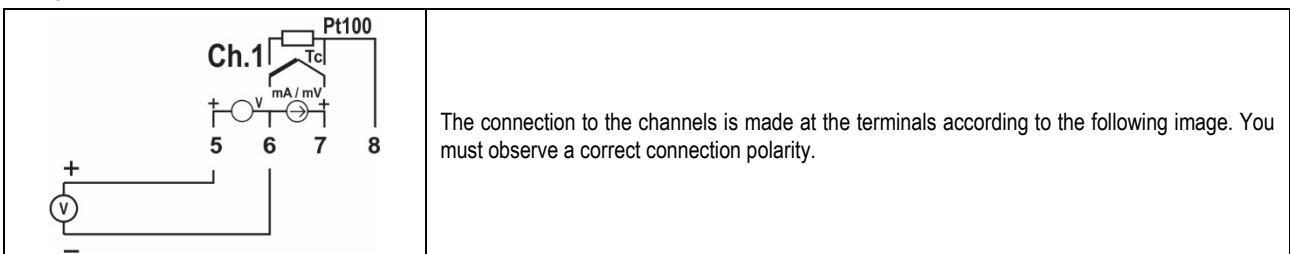

14.2.3.4.1 EXAMPLE OF CONNECTION OF 4-20 mA TRANSMITTERS POWERED BY THE CURRENT LOOP

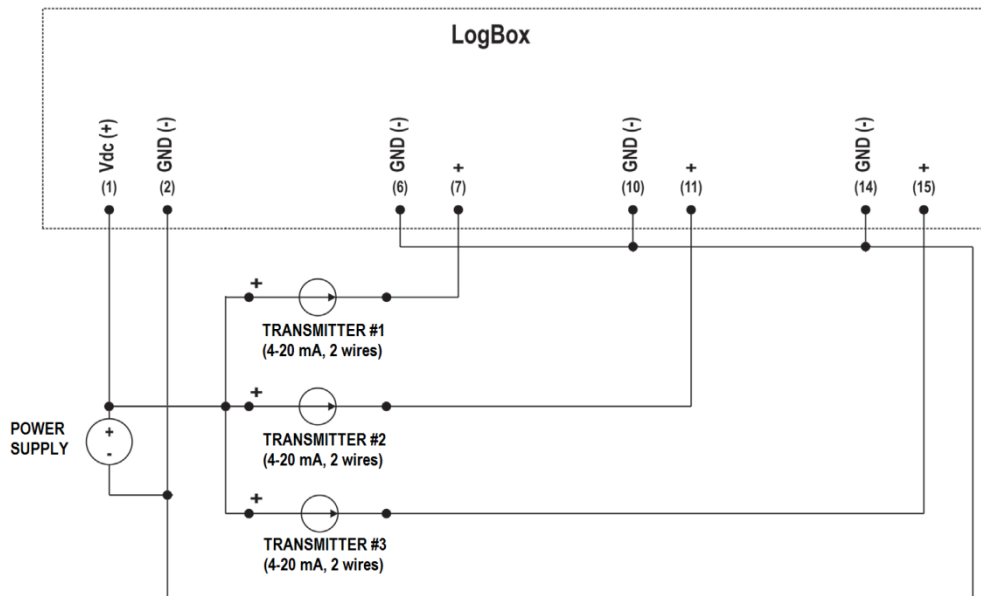



Figure 56 – Example of connecting transmitters that are fed by the loop

15. COMMUNICATION INTERFACES

15.1 USB

The USB interface is the preferred interface for configuring, monitoring, and downloading device logs. It is the only interface which can never be disabled. To access it, you must install **NXperience** for Windows. This way, the USB driver will be installed (see chapter [NXperience](#)). A standard micro-USB cable (not supplied) must be used for desktop or notebook connection.

When connecting the USB cable, the respective icon should light up on the device's display, indicating that its interface is ready for use. On first use, you must wait for Windows to automatically install the driver already preinstalled by **NXperience**. The device's configuration, monitoring and data download, made through the USB interface, must be performed by **NXperience**.

 	<p>The USB interface is NOT insulated.</p> <p>Its purpose is temporary use during CONFIGURATION, MONITORING, and LOG DOWNLOAD. For the safety of people and devices, it should only be used when the device is disconnected from the external power supply.</p> <p>It is possible to use the USB interface in any other connection condition, although the decision requires a careful analysis by the person in charge of installation.</p>
--	--

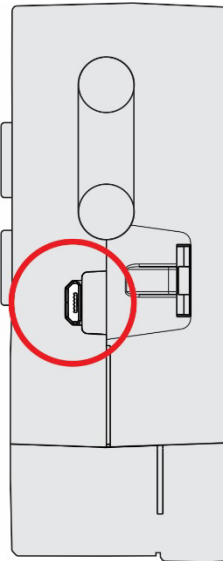





Figure 57 – USB cable connection

15.2 WI-FI

LogBox Wi-Fi has an 802.11 interface in 2.4 Ghz b/g/n standards for sending registered data through protocols compatibles with the device. The Wi-Fi interface also sends some device's configuration parameters of the **LogBox Wi-Fi** through these same protocols.

This interface supports WPA-Personal (PSK) WPA/WPA2 TKIP/AES/TKIP and AES encryption.

If the Wi-Fi interface is enabled and the device is connected to a Wi-Fi network, the  symbol will remain lit. While data is being sent through this interface, the symbol  will remain lit.

	<p>While the LogBox Wi-Fi is operating on batteries and to reduce power consumption, Wi-Fi will remain disabled. All other features of the device, however, remain operable for at least one year.</p> <p>When power from the power supply is restored, the Wi-Fi interface will be activated, and the data recorded in memory during the power interruption will be published.</p>
---	---

16. FIRMWARE UPDATE

LogBox Wi-Fi has two firmwares: 1 located on the motherboard, which must be updated via USB, and 1 located on the Wi-Fi module, which must be updated by Over the Air technology. In a firmware update, it is important to update both. To do so, make sure you get the correct firmware versions from the **NOVUS** website and update the motherboard and the Wi-Fi module.

16.1 FIRMWARE UPDATE VIA USB

You can update the device firmware using the **NXperience** software. On the home screen, simultaneously press the Ctrl + Shift + F12 keys. A firmware update screen will appear:

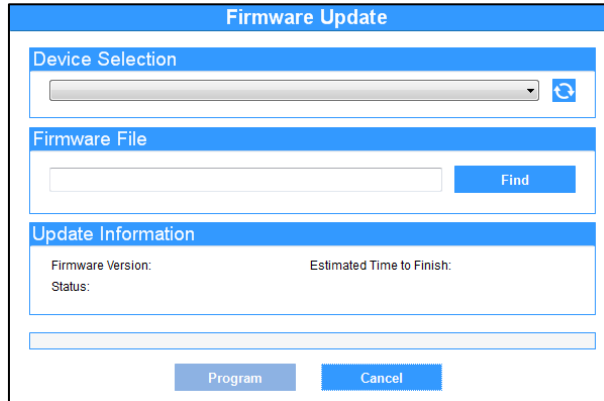

Figure 58 – Firmware update

Once this is done, select the device to be updated, add the firmware file to be used and click the **Program** button.

16.2 OVER THE AIR (OTA) FIRMWARE UPDATE

The **LogBox Wi-Fi** module can be upgraded using Over the Air (OTA) technology.

To perform this procedure, you must know the device's IP. After that, you will need to access it through a Browser. In the address bar, you must enter the device's IP address: /novus_logbox/upgrade (192.168.88.86/novus_logbox/upgrade (192.168.12.33, for example).

Once the Browser loads the device firmware update page, you will need to upload a .bin file, which contains the Wi-Fi module new firmware version.

The firmware update through this interface has the objective of updating network services such as MQTT, Modbus-TCP, among others. For a complete upgrade, you must use the **NXperience** software and update the rest of the device via USB.

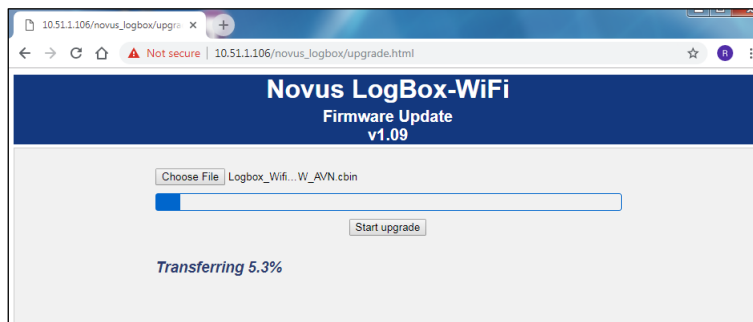

Figure 59 – Firmware update

17. CFR 21 REGULATION

17.1 SUPPORT FOR CFR 21 PART 11 AND RDC 17:2010 VALIDATION

LogBox Wi-Fi can be part of a validated system by offering the following features for compliance support:

- Device development follows the company's quality standard. It has the ISO 9001 certification and follows good manufacturing practices, the basis for compliance with GAMP 5 requirements in validation model V.
- Device usage documentation will be available during the validation process, functional specification, and final acceptance testing.
- The produced devices are identified by a serial number that allows tracking at the factory and that makes it possible to identify their calibration report and other production information.
- All data recorded in the device's memory, whether of basic configuration, calibration, or involving the inputs readings, are protected against improper tampering.
- Access to the basic configuration and calibration parameters is done only by **NXperience** and with access credentials. These credentials are unique and, for traceability purposes, should be associated with a person in charge.
- The memory containing the basic configuration and calibration is protected by a mechanism that detects any improper changes. The mechanism is composed of an electronic signature (*hash*). Any change in the parameters will be identified by a change in the electronic signature, accessible for reading by the monitoring system.
- Access to the data of the entries registered in the device's memory is done only through **NXperience** and by access credentials. This data is illegibly present in the memory and can be exported to readable formats while keeping the font unchanged.
- The device allows only the modification of the operational parameters, which audit changes trail must be built in the supervisory system. These parameters consist of alarm Setpoints and the action of enabling or disabling the buzzer on the device.

18. TROUBLESHOOTING

18.1 START/STOP MODES

Depending on the Start/Stop rule with which the device is configured, it may lose information if it is to continue registering during a power outage.

- **Start/Stop by Keyboard:** A Modbus command or digital input may be lost during the device's power-up.
- **Immediate Start:** "Date/Time" or "Daily" parameters will return when the device is powered up again and is able to resume the clock.

18.2 CLOCK

After a power failure, the **LogBox Wi-Fi** cannot reset the clock on its own. Therefore, if the clock information is lost, the device will not log until it is reconfigured.

After the clock is reset, data logging will automatically resume if the end mode meets the following conditions:

- **Non-Stop** or
- **Date/Time** (if it satisfies the parameters set according to the new clock setting) or
- **Daily** (according to the time configured).

In case of a power failure, the **LogBox Wi-Fi** also does not retain the last value of the Accumulator Pulse Count. Therefore, when initializing the device after the clock is lost, the **LogBox Wi-Fi** will assume as the value of the Accumulator Pulse Count the data present in the last register.

18.3 ALARM INFORMATION

Alarm information, maximum and minimum values reached in each channel, as well as Date/Time of the last event are data that can be lost if the device is left out of power for more than 30 minutes. The data logged in the periodicity of logs or the digital input events, if it is configured for Event Log, are the only ones that are certainly not lost (unless a new configuration is applied, or the user chooses to clear the memory).

NXperience has the functionality of reporting the maximum and minimum values logged, as well as informing all logs in an alarm situation.

18.4 ANALOG INPUTS

- When a device that is connected to the mains (a thermocouple or voltage simulator, for example) is used in the analog inputs and is not isolated, it is recommended to use a different reading interface than USB. In some cases, due to the influence of the USB cable connection (probably by ground loops), the occurrence of noise and reading Offsets have been detected.
- When operated by batteries and no acquisition is being performed, **LogBox Wi-Fi** will keep the analog circuit switched off. This strategy is necessary so that it can operate for more than two years without needing to change batteries. However, some analog signal simulators (thermocouple simulator or Pt100, for example) may not be able to operate correctly with this characteristic, causing false Offsets and oscillations in the readings. If such a problem is identified, it is recommended to power the **LogBox Wi-Fi** by external power supply or By USB port while using the simulator.
- Setting the local network frequency (50 Hz or 60 Hz) is important to improve the analog channels' reading performance, even if the device is running on battery power. Usually, the power grid causes interference, which can be more easily mitigated if its frequency is known on the signal read by the sensors.

18.5 UNREGISTERED ALARMS

The alarm status information, as well as the maximum and minimum values reached in each channel, is updated by any events that trigger an acquisition, which may be a read in the log range or in the display update range. If a channel reaches a minimum or maximum value or an alarm condition during an acquisition that does not occur during the log range, it may not be logged in the memory. Thus, statuses may indicate that the channel has already reached one of these situations and the information is not available in a download.

The log range must be configured according to the maximum period allowed by the process being monitored, so that no important information is lost (and no longer being logged).

18.6 COMMUNICATION LINK LOSS

If there is a loss of the communication link between the Broker and any of the Subscribers or the possible lack of electricity, it is possible that Subscriber will lose some of the logs subsequently published by **LogBox Wi-Fi**. If this occurs, the `set_download` topic allows you to request that the device resend the logs that were lost during that period, by setting a start date for it (see [Inscription Topic](#) section of the [MQTT Protocol](#) chapter).

18.7 PROBLEMS COMMUNICATING WITH THE DEVICE VIA USB INTERFACE

If you have problems communicating the device via the USB interface, it is recommended to perform the following procedure to speed communication and minimize incompatibility issues:

- a. Open the Device Manager:

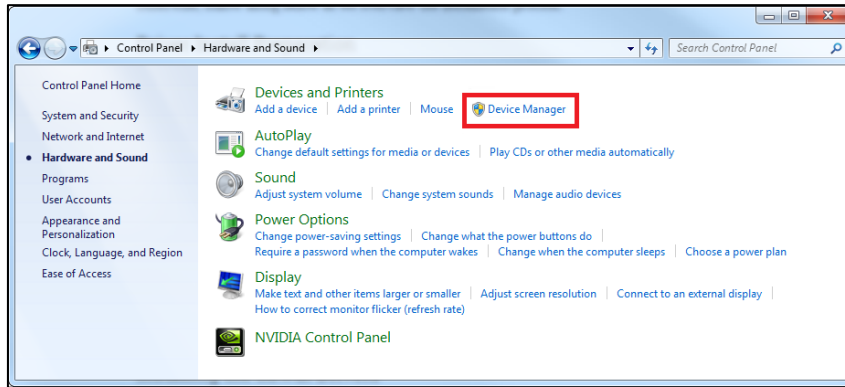

Figure 60 – Device Manager

b. Open the COM port setting of the device:

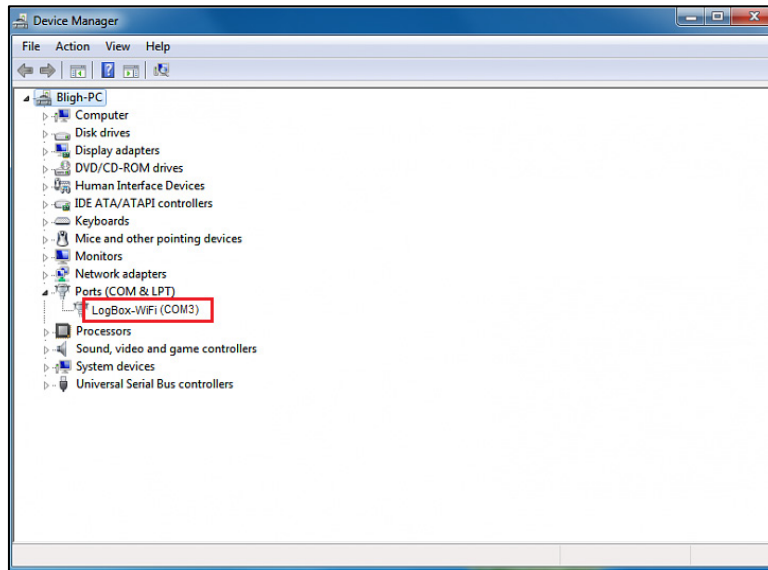

Figure 61 – Device Manager

c. Open advanced COM port configuration options:

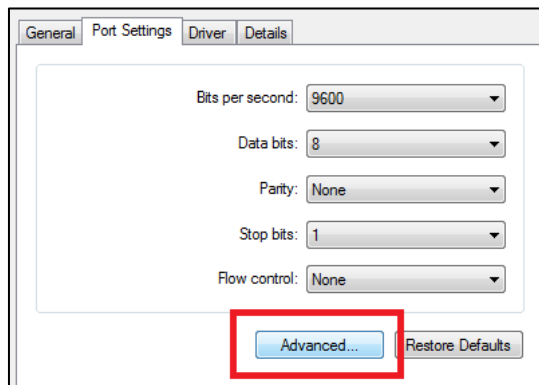

Figure 62 – Port settings configuration

d. Uncheck the Use FIFO buffers option:

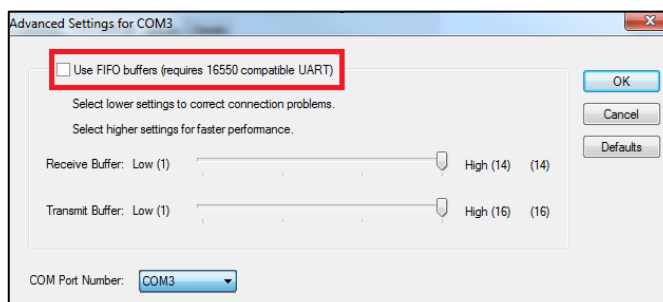

Figure 63 – Advanced settings

18.8 PROBLEMS DURING FIRMWARE UPDATE VIA USB INTERFACE

If there are problems during the firmware update, it is recommended to perform the following procedure:

Before upgrading the firmware, verify if the latest version of **NXperience** has been installed.

If a failure occurs during firmware update, the following message will be displayed:



Figure 64 – Firmware failure

Click **OK** and verify if the device is still available for the update. If it is, click on **Program** again:

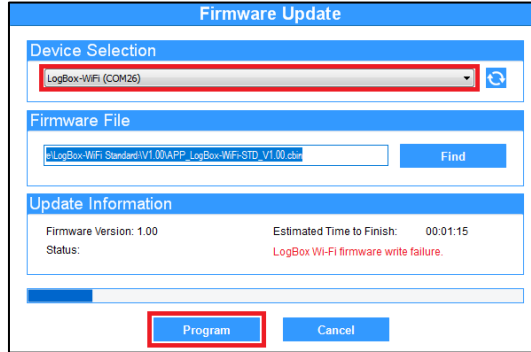

Figure 65 – Firmware update

If **NXperience** has been closed and/or it is no longer possible to find the device on the update screen, it is necessary to close the **NXperience**, turn off the **LogBox Wi-Fi** and reconnect the device to the USB interface for a new attempt.

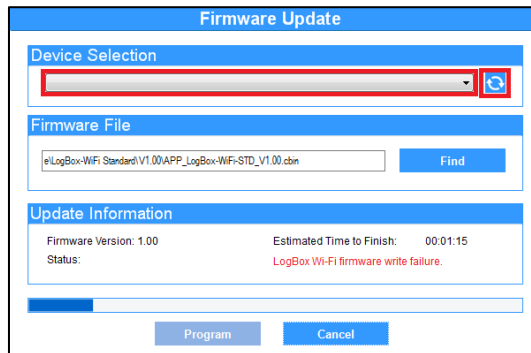

Figure 66 – Firmware failure

If the **NXperience** shows an error while reading the configuration, as shown in the figure below, and the device display is off, try the procedure described in the following step.

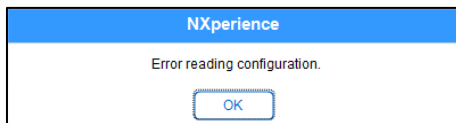

Figure 67 – Error reading configuration

On the **NXperience** startup screen, pressing the **Ctrl + Shift + F12** keys simultaneously will cause the firmware update screen to reappear, as shown in **Fig. 70**.

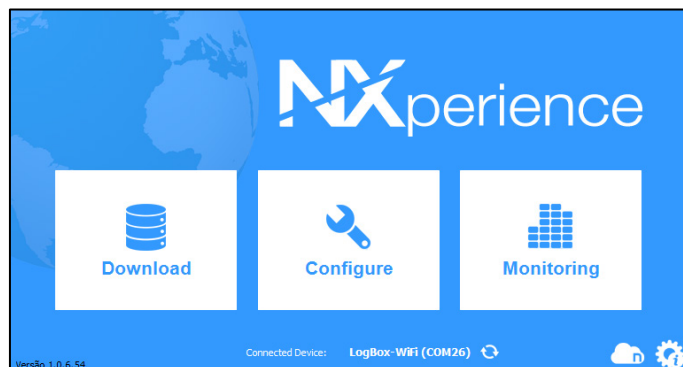

Figure 68 – NXperience home screen

The screenshot shows a 'Firmware Update' dialog box. It has a blue title bar. Below the title bar, there are three main sections. The first section, 'Device Selection', contains a dropdown menu and a refresh icon. The second section, 'Firmware File', contains a text input field and a 'Find' button. The third section, 'Update Information', contains labels for 'Firmware Version:', 'Estimated Time to Finish:', and 'Status:'. At the bottom of the dialog, there are two buttons: 'Program' and 'Cancel'.

Figure 69 – Firmware update

Try to update the firmware again. If you cannot find the device, turn off the **LogBox Wi-Fi** and switch it back on by holding down both keys. After that, repeat this procedure.

In case of failure during previous procedures, contact **NOVUS** technical support.

19. TECHNICAL SPECIFICATIONS

FEATURES	LOGBOX WI-FI	
Input Channels	3 analog inputs 1 digital input	
Compatible Analog Signals	Thermocouple J, K, T, N, E, R, S and B, Pt100, 0-50 mV, 0-5 V, 0-10 V, 0-20 mA, 4-20 mA	
Internal Measurements	Internal Temperature (NTC) Battery Voltage External Power Supply Source Voltage	
Analog Channels Input Impedance	Thermocouples / Pt100 / mV: > 2 M Ω mA: 15 Ω + 1.5 V V: 1 M Ω	
Pt100	Maximum cable offset resistance: 25 Ω Excitation Current: 166 μ A Used Curve: $\alpha = 0.00385$	
Digital Input	Logical Levels	Logical Level "0": from 0 to 0.5 VDC Logical Level "1": from 3 to 30 VDC
	Maximum Voltage	30 VDC
	Input Impedance	270 k Ω
	Input Current @ 30 VDC (typical)	150 μ A
	Maximum Frequency (squared wave)	Dry Contact: 10 Hz PNP: 2 kHz NPN: 2 kHz
Digital Output	Minimum Pulse Duration	Dry Contact: 50 ms PNP: 250 μ s NPN: 250 μ s
	1 PNP-type output Maximum current that can be switched at the output: 200 mA	
Display	3 lines, 4½ digits	
Resolution	Analog Signals: 15 bits (32768 levels) Digital Signal: 16 bits (65536 levels) Digital Signal (Accumulator): 32 bits (4294967296 levels)	
Memory Capacity	140000 logs (total)	
Log Range	1 second to 18 hours	
Log Type	Instant or Medium	
Log Trigger	Date/Time, Start button, digital input, software command or alarm	
Alarms	10 available alarms	
Internal Buzzer	Yes, it can be used for alarms	
Communication Interfaces	USB Interface Wi-Fi 802.11 b/g/n 2.4 GHz Interface, supporting WPA-Personal (PSK) WPA/WPA2 TKIP/AES/TKIP and AES encryption	
Software and App	NXperience (By USB or by TCP/IP network for desktops and notebooks) NXperience Mobile (By Wi-Fi for smartphones)	
Power supply	Power Supply Source	Voltage: 10 VDC to 30 VDC Maximum Consumption: 300 mA Typical Consumption: 20 mA
	Batteries	4 "AA" type alkaline batteries (included) (Wi-Fi interface disabled)
Estimated Battery Life	Maintenance of batteries is required (typically every 2 years, considering a 5-minute recording interval with Wi-Fi interface disabled)	
Operation Temperature	Using the included batteries: -10 to 50 °C Using <i>Energizer L91</i> batteries: -20 to 60 °C Using external power supply: -20 to 70 °C *	
Housing	ABS+PC	
Protection Index	IP40	

FEATURES	LOGBOX WI-FI
Dimensions	120 x 100 x 40 mm
Certifications	CE, UKCA, FCC, CAN ICES-3 (A) / NMB-3 (A), ANATEL (07034-17-07089)

Table 17 – Technical specifications

* Be careful with the operating temperature of the batteries. Extremely high or low temperatures can cause ruptures and leaks and cause damage to the device.

19.1 SENSORS RANGE AND ACCURACY

	Sensor	Sensor Minimum Value	Sensor Maximum Value	Sensor Resolution	Accuracy (%)
Thermocouples	J	-100.0 °C -148.0 °F	760.0 °C 1400.0 °F	0.1 °C 0.2 °F	0.15 % (F. E.) ± 0.5 °C
	K	-150.0 °C -238.0 °F	1370.0 °C 2498.0 °F	0.1 °C 0.2 °F	0.15 % (F. E.) ± 0.5 °C
	T	-160.0 °C -256.0 °F	400.0 °C 752.0 °F	0.1 °C 0.2 °F	0.15 % (F. E.) ± 0.5 °C
	N	-270.0 °C -454.0 °F	1300.0 °C 2372.0 °F	0.1 °C 0.2 °F	0.15 % (F. E.) ± 0.5 °C
	E	-90.0 °C -130 °F	720.0 °C 1328.0 °F	0.1 °C 0.2 °F	0.15 % (F. E.) ± 0.5 °C
	R	-50.0 °C -58.0 °F	1760.0 °C 3200.0 °F	0.3 °C 0.5 °F	0.15 % (F. E.) ± 0.5 °C
	S	-50.0 °C -58.0 °F	1760.0 °C 3200.0 °F	0.4 °C 0.7 °F	0.15 % (F. E.) ± 0.5 °C
	B	500.0 °C 932.0 °F	1800.0 °C 3272.0 °F	0.4 °C 0.7 °F	0.15 % (F. E.) ± 0.5 °C
Pt100	Pt100	-200.0 °C -328.0 °F	650.0 °C 1202.0 °F	0.1 °C 0.2 °F	0.15 % (F. E.)
Linear	0 to 50 mV	0.000	50.000	0.003 mV	0.15 % (F. E.)
	0 to 5 V	0.000	5.000	0.6 mV	0.15 % (F. E.)
	0 to 10 V	0.000	10.000	0.6 mV	0.15 % (F. E.)
	0 to 20 mA	0.000	20.000	0.001 mA	0.15 % (F. E.)
	4 to 20 mA	4.000	20.000	0.001 mA	0.15 % (F. E.)
Digital Input	Count Mode	0	65535		0.01 % (F. E.)
Internal Sensors	Temperature (NTC)	-40 °C -40 °F	125.0 °C 257.0 °F	0.1 °C 0.1 °F	0.15 % (F. E.) ± 0.5 °C
	Battery Voltage	3.6	6.5	0.01 V	2 % (F. E.)
	External Power Supply Voltage	10.00	30.00	0.01 V	2 % (F. E.)

* F. E. = Full Scale = Span

Table 18 – Sensors range and accuracy

Accuracy: The sensor accuracy reading is measured in relation to the Full Scale and is proportional to the maximum measuring range of each sensor. For a Pt100 sensor, for example, which the **LogBox Wi-Fi** can read in the range of -200 °C to 650 °C, with a precision of 0.15%, the accuracy in °C will be $(650\text{ °C} - (-200\text{ °C})) * 0.15\% = 1.28\text{ °C}$.

Thermocouples: The analog input circuit for the **LogBox Wi-Fi** guarantees the accuracy specified in the Thermocouple sensors reading with a maximum cable impedance of 100 Ω. Thermocouple sensors with impedance above 100 Ω are read by **LogBox Wi-Fi**. Accuracy, however, is not guaranteed. For reading the thermocouple sensors, the **LogBox Wi-Fi** uses the internal temperature sensor for Cold Joint compensation (NTC). Just as with the internal temperature sensor, thermocouples may present a greater error than specified when there are sudden variations in ambient temperature. The specified accuracy is only guaranteed when the device is installed in an environment with a stable temperature for a time greater than one hour.

Pt100: The **LogBox Wi-Fi** analog input circuit guarantees the accuracy specified in the reading of PT100 type sensors with a maximum cable resistance of up to 25 Ω. The device can read sensors with cables that have resistance above 25 Ω. In these cases, the accuracy and measurement range are not guaranteed. The **LogBox Wi-Fi** performs the cable resistance compensation internally, if it is the same in the three wires that connect the device to the sensor.

Linear 0 to 50 mV: The analog input circuit of the **LogBox Wi-Fi** guarantees the specified accuracy when reading electrical quantities of voltage type 0 to 50 mV with a maximum cable impedance of up to 100 Ω. Voltage sources with series impedance above 100 Ω can be read by **LogBox Wi-Fi**. Accuracy, however, is not guaranteed.

Linear 0 to 5 V and 0 to 10 V: The analog input circuit of the **LogBox Wi-Fi** guarantees the specified accuracy when reading electrical quantities of voltage type 0 to 5 V and 0 to 10 V with a maximum cable impedance of up to 200 Ω. Voltage sources with series impedance above 200 Ω can be read by **LogBox Wi-Fi**. Accuracy, however, is not guaranteed.

Linear 0 to 20 mA and 4 to 20 mA: All **LogBox Wi-Fi** input channels have common ground with each other as well as with the power supply source. Thus, for the **LogBox Wi-Fi** to be able to correctly measure the current transmitters, it is necessary that they are fed by isolated sources or by using all current transmitters with the interconnected ground.

Digital Input: All **LogBox Wi-Fi** input channels have common ground with each other as well as with the power supply source. For the **LogBox Wi-Fi** to correctly measure the Digital Input sensor, such characteristic must be considered. For the logic levels of the sensor connected to the digital input to be correctly detected, it is recommended that the maximum series impedance with the sensor is less than 10 kΩ.

Internal Temperature Sensor: The **LogBox Wi-Fi** has an internal temperature sensor of the NTC type that can be used for monitoring the ambient temperature. This sensor is used for the Thermocouples Cold Joint compensation. Because it is located inside the device's casing, it may present a greater error than specified when there are abrupt variations in ambient temperature. The specified accuracy is only guaranteed when the device is installed in an environment with a stable temperature for a time greater than one hour. The sensor allows readings in a range of -40 °C to 125 °C. The temperature, however, is limited to the device's operating range.

19.2 WIRELESS CONNECTIVITY

LogBox Wi-Fi has a wireless connectivity module for communicating with 2.4GHz 802.11 b/g/n Wi-Fi networks. The Wi-Fi connectivity module used is AES-BCM4343W-M1-G, from manufacturer Avnet, which provides data connectivity over Wi-Fi.

FEATURES	DESCRIPTION
WLAN Standards	IEEE 802 Part 11b/g/n (802.11b/g/n single stream n)
Antenna Port	Supports single antenna for Wi-Fi
Frequency Band	2.400 – 2.484 GHz

Table 19 – WLAN standards supported by **LogBox Wi-Fi**

FEATURES	DESCRIPTION
Frequency band	2.400 – 2.497 GHz (2.4 GHz ISM Band)
Number of selectable sub-channels	14 Channels
Modulation	OFDM, DSSS (Direct Sequence Spread Spectrum), DBPSK, DQPSK, CCK, 16QAM, 64QAM
Supported rates	1, 2, 5.5, 11, 6, 9, 12, 24, 36, 48, 54 Mbps e HT20 MCS 0~7
Maximum receive input level	-10 dBm (with PER < 8 % @ 11 Mbps) -20 dBm (with PER < 10 % @ 54 Mbps) -20 dBm (with PER < 10 % @ MCS7)
Output power	17 dBm @ 802.11b 13 dBm @ 802.11g 12 dBm @ 802.11n
Carrier frequency accuracy	+/- 20 ppm (Crystal: 26 MHz +/- 10 ppm @ 25 °C)

Table 20 – WLAN Specifications of the Wi-Fi Connectivity Module

19.3 CERTIFICATIONS

FCC

Contains FCC ID: N7NHL8549G

This device has been tested and found to comply with the limits for a Class A digital device, pursuant to Part 15 of the FCC Rules. These limits are designed to provide reasonable protection against harmful interference when the device is operated in a commercial environment. This device generates, uses, and can radiate radio frequency energy and, if not installed and used in accordance with the instruction manual, it may cause harmful interference to radio communications.

Any changes or modifications not expressly approved by the party responsible for compliance could void the user's authority to operate this device.

RF Exposure: To satisfy FCC RF exposure requirements, a separation distance of 20 cm or more should be maintained between the antenna of this device and persons during operation. To ensure compliance, operations at closer distances than this are not recommended. This device and its antenna(s) must not be co-located or operating in conjunction with any other antenna or transmitter.

This device complies with part 15 of the FCC Rules. Operation is subject to the following two conditions: (1) This device may not cause harmful interference, and (2) this device must accept any interference received, including interference that may cause undesired operation.

IC

Contains IC: 21571-AVTEG001

This device complies with Industry Canada's license exempt RSS standard(s). Operation is subject to the following two conditions: (1) This device may not cause interference, and (2) This device must accept any interference, including interference that may cause undesired operation of the device.

The installation of the transmitter must ensure that the antenna has a separation distance of at least 20 cm from all persons or compliance must be demonstrated according to the ISED SAR procedure.

Under Industry Canada regulations, this radio transmitter may only operate using an antenna of a type and maximum (or lesser) gain approved for the transmitter by Industry Canada. To reduce potential radio interference to other users, the antenna type and its gain should be so chosen that the equivalent isotopically radiated power (EIRP) is not more than that necessary for successful communication.

CE Mark / UKCA

This is a Class A device. In a domestic environment, it may cause radio interference and require the user to take proper measures.

ANATEL

This device is homologated by ANATEL, in accordance with the procedures regulated by Resolution 242/2000, and meets the technical requirements applied.

This equipment is not subject to the protection from harmful interference and may not cause interference with duly authorized systems.

For more information, see the ANATEL website www.gov.br/anatel/pt-br.

NORM CISPR 22

This product is not suitable for use in domestic environments as it may cause electromagnetic interference. Otherwise, the user will be required to take whatever measures are necessary to minimize such electromagnetic interference.

20. WARRANTY

The warranty conditions are set forth on our website www.novusautomation.com/warranty.