

250 mm

- ✓ M18 short housing
- ✓ Sensitivity adjustment via potentiometer
- ✓ IO-Link
- ✓ Excellent black/white behavior
- ✓ Immunity to mutual interferences

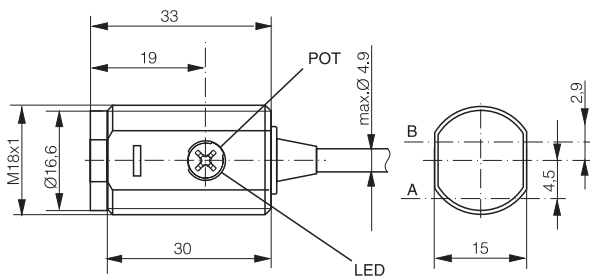

A: emitter axis B: receiver axis

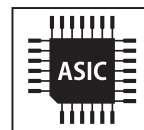
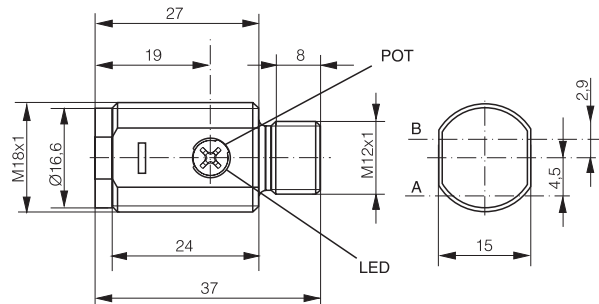

A: emitter axis B: receiver axis

OPTICAL DATA		INTERFACE	
Sensing range typ. max.	10...250 mm ¹	Sensitivity adjustment	30...250 mm, 3/4-turn pot.
Operating range	15...210 mm ¹	Indicator LED, green	Excess gain
Light source	Pinpoint LED, red 640 nm	Indicator LED, yellow	Sensing state
Light spot size (distance)	Ø 6 mm (100 mm)/Ø 10 mm (250 mm)	IO-Link	✓
		MTTF (@40°C)	554 y

¹Object with 90% reflectance (standard white paper)

ELECTRICAL DATA		MECHANICAL DATA	
Supply voltage range (U _b)	10...30 VDC	Enclosure rating	IP67
Residual ripple	≤ 10% V _{pp}	Ambient temperature operation	-25...+65°C
Output current	≤ 200 mA	Shock and vibration	IEC 60947-5-2
Signal PNP high/low	≤ (U _b -2.0 V)/approx. 0 V	Weight (connector version)	6 g
Signal NPN high/low	Approx. U _b /≤ 2.0 V	Weight (cable version)	71 g
Power consumption (no load)	≤ 30 mA	Housing material	ABS
Response time ¹	≤ 700 μs (normal)/≤ 1.1 ms/≤ 500 μs	Window material	PMMA
Switching frequency ¹	≤ 700 Hz (normal)/≤ 450 Hz/≤ 1 kHz	Connection cable	PVC, 2 m, 3-wire or 4-wire
Short circuit protection	✓	Connector type	M12 4-pin
Voltage reversal protection	✓	Max tightening torque	1 Nm

¹By default, "Normal" mode. "Fine" and "Fast" modes selectable via IO-Link.

BACKGROUND SHIFT

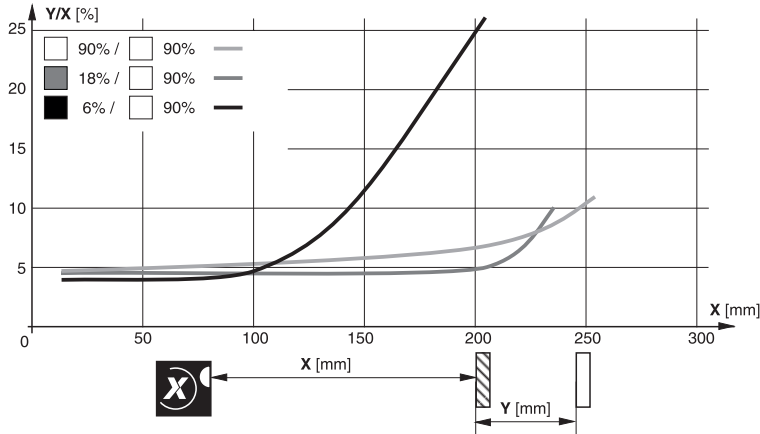

IO-LINK FUNCTIONALITIES

STABILITY ALARM OUTPUT (A2)

IO-Link version	1.0
SIO mode	Supported
Process data	Detection state & stability alarm
Baudrate	COM2 (38.4 kBaud)
Special functions	Output configuration, output timing, sensor mode, detection counter, event flags, maximum and actual sensor temperature

IO-Link specifications and IODD files may be downloaded from www.contrinex.com (Download section)

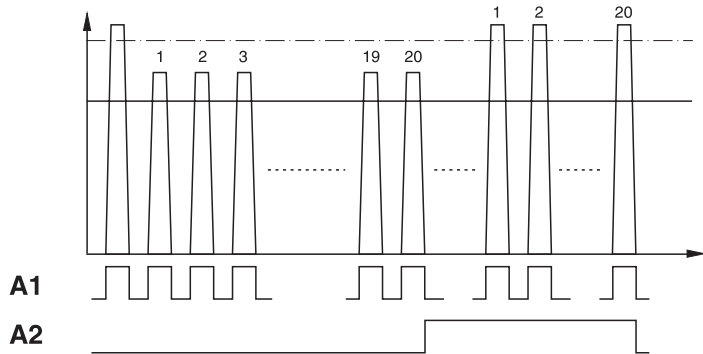

WIRING DIAGRAM

PIN ASSIGNMENT

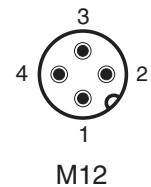
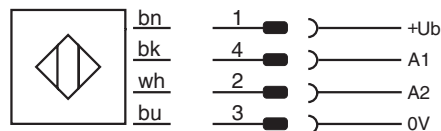
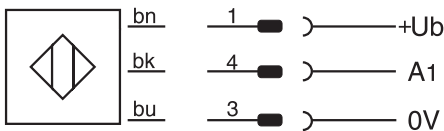

AVAILABLE TYPES

Part number	Part reference	Polarity	Connection	Output (A1)	Output (A2)
620 600 208	LHR-M18PA-PMK-403	PNP	PVC, 2 m, 3-wire	Light-on/IO-Link	-
620 600 209	LHR-M18PA-PMK-603	PNP	PVC, 2 m, 4-wire	Light-on/IO-Link	Dark-on
620 600 210	LHR-M18PA-PMK-60C	PNP	PVC, 2 m, 4-wire	Light-on/IO-Link	Stability alarm
620 600 211	LHR-M18PA-PMK-301	NPN	PVC, 2 m, 3-wire	Light-on	-
620 600 212	LHR-M18PA-PMK-101	NPN	PVC, 2 m, 4-wire	Light-on	Dark-on
620 600 213	LHR-M18PA-PMK-10A	NPN	PVC, 2 m, 4-wire	Light-on	Stability alarm
620 600 214	LHR-M18PA-PMS-403	PNP	Connector M12 4-pin	Light-on/IO-Link	-
620 600 215	LHR-M18PA-PMS-603	PNP	Connector M12 4-pin	Light-on/IO-Link	Dark-on
620 600 216	LHR-M18PA-PMS-60C	PNP	Connector M12 4-pin	Light-on/IO-Link	Stability alarm
620 600 217	LHR-M18PA-PMS-301	NPN	Connector M12 4-pin	Light-on	-
620 600 218	LHR-M18PA-PMS-101	NPN	Connector M12 4-pin	Light-on	Dark-on
620 600 219	LHR-M18PA-PMS-10A	NPN	Connector M12 4-pin	Light-on	Stability alarm

Note: additional suffix can appear to indicate a revision version or a special version.

Operators of the products we supply are responsible for compliance with measures for the protection of persons. The use of our equipment in applications where the safety of persons might be at risk is only authorized if the operator observes and implements separate, appropriate and necessary measures for the protection of persons and machines. Terms of delivery and rights to change design reserved.

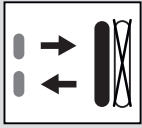

250 mm

- ✓ Boîtier court M18
- ✓ Réglage de la sensibilité via potentiomètre
- ✓ IO-Link
- ✓ Excellent comportement noir/blanc
- ✓ Immunité aux interférences mutuelles

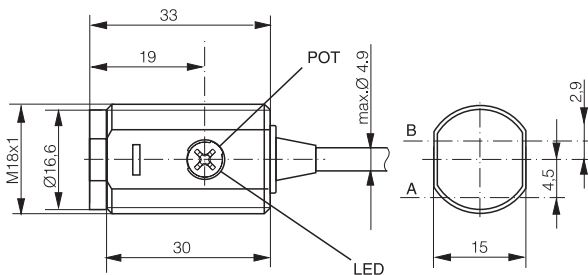
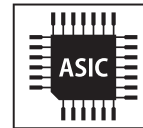

A: axe de l'émetteur B: axe du récepteur

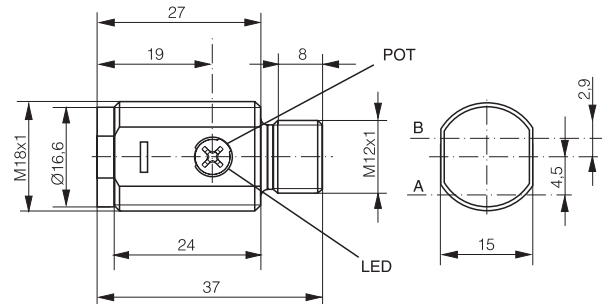

A: axe de l'émetteur B: axe du récepteur

DONNÉES OPTIQUES		INTERFACE	
Domaine de détection typ. max.	10...250 mm ¹	Réglage sensibilité	30...250, pot. à 3/4 tour
Domaine de fonctionnement	15...210 mm ¹	Indicateur LED, vert	Réserve de fonctionnement
Source lumineuse	Pinpoint LED, rouge 640 nm	Indicateur LED, jaune	Etat de détection
Taille tache lumineuse (distance)	Ø 6 mm (100 mm)/ Ø 10 mm (250 mm)	IO-Link	✓
		MTTF (@40°C)	554 y

¹ Objet avec 90% de réflectance (papier blanc standard)

DONNÉES ÉLECTRIQUES		DONNÉES MÉCANIQUES	
Tension d'alimentation (Ub)	10...30 VDC	Indice de protection	IP67
Ondulation résiduelle	≤ 10 Vpp	Temp. ambiante d'utilisation	-25...+65°C
Courant de sortie	≤ 200 mA	Chocs et vibrations	IEC 60947-5-2
Tension de sortie haut/bas (PNP)	≤ (Ub-2.0 V)/ approx. 0 V	Poids (version connecteur)	6 g
Tension de sortie haut/bas (NPN)	Approx. Ub/ ≤ 2.0 V	Poids (version câble)	71 g
Consommation (hors charge)	≤ 30 mA	Matériau du boîtier	ABS
Temps de réponse ¹	≤ 700 µs (normal)/ ≤ 1.1 ms/ ≤ 500 µs	Matériau de la fenêtre	PMMA
Fréquence de commutation ¹	≤ 700 Hz (normal)/ ≤ 450 Hz/ ≤ 1 kHz	Câble de raccordement	PVC, 2 m, 3 fils ou 4 fils
Protection contre les courts-circuits	✓	Type de connecteur	M12 4 pins
Protection contre les inversions	✓	Couple de serrage max.	1 Nm

¹ Par défaut, mode "Normal". Modes "Fine" et "Fast" sélectionnables via IO-Link.

DÉCALAGE DE L'ARRIÈRE-PLAN

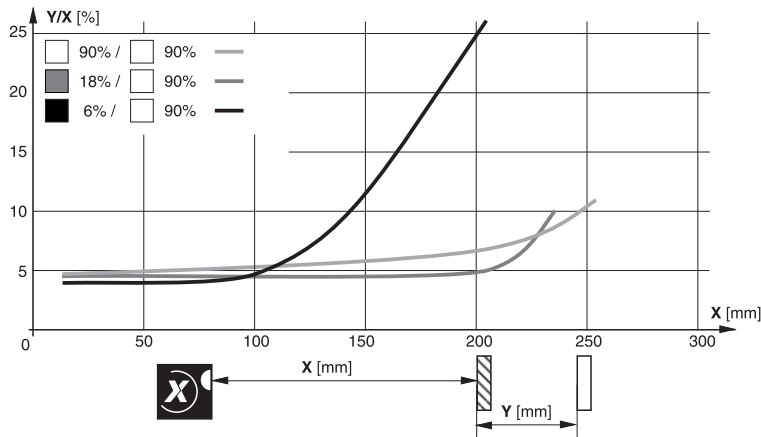

FONCTIONNALITÉS IO-LINK

SORTIE ALARME DE STABILITÉ (A2)

Version IO-Link	1.0
Mode SIO	Disponible
Process data	Etat de détection et alarme stabilité
Baudrate	COM2 (38.4 kBaud)
Fonctions spéciales	Configuration sortie, temporisation sortie, mode du capteur, compteur de détections, flags d'erreur, température max. et actuelle du capteur

Les spécifications IO-Link et les fichiers IODD peuvent être téléchargés depuis www.contrinex.com (onglet Télécharger)



SCHÉMA DE RACCORDEMENT

ATTRIBUTION DES PINS

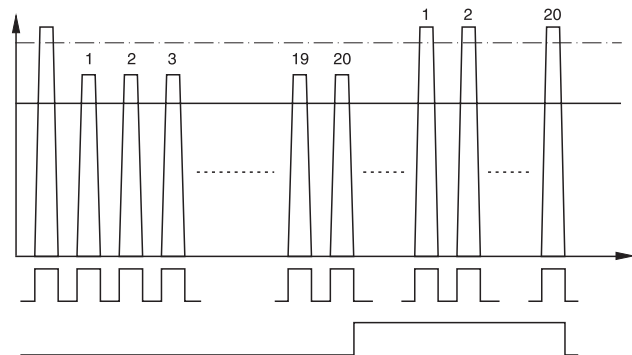
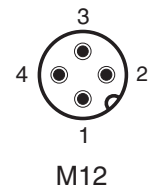
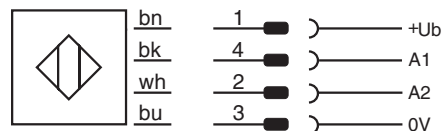
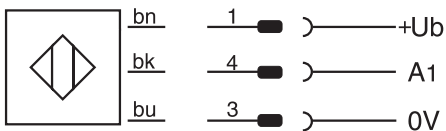

TYPES DISPONIBLES

Numéro d'article	Désignation	Polarité	Raccordement	Sortie (A1)	Sortie (A2)
620 600 208	LHR-M18PA-PMK-403	PNP	PVC, 2 m, 3 fils	En réception/IO-Link	-
620 600 209	LHR-M18PA-PMK-603	PNP	PVC, 2 m, 4 fils	En réception/IO-Link	Sans réception
620 600 210	LHR-M18PA-PMK-60C	PNP	PVC, 2 m, 4 fils	En réception/IO-Link	Alarme de stabilité
620 600 211	LHR-M18PA-PMK-301	NPN	PVC, 2 m, 3 fils	Light-on	-
620 600 212	LHR-M18PA-PMK-101	NPN	PVC, 2 m, 4 fils	Light-on	Sans réception
620 600 213	LHR-M18PA-PMK-10A	NPN	PVC, 2 m, 4 fils	Light-on	Alarme de stabilité
620 600 214	LHR-M18PA-PMS-403	PNP	Connecteur M12 4 pins	En réception/IO-Link	-
620 600 215	LHR-M18PA-PMS-603	PNP	Connecteur M12 4 pins	En réception/IO-Link	Sans réception
620 600 216	LHR-M18PA-PMS-60C	PNP	Connecteur M12 4 pins	En réception/IO-Link	Alarme de stabilité
620 600 217	LHR-M18PA-PMS-301	NPN	Connecteur M12 4 pins	Light-on	-
620 600 218	LHR-M18PA-PMS-101	NPN	Connecteur M12 4 pins	Light-on	Sans réception
620 600 219	LHR-M18PA-PMS-10A	NPN	Connecteur M12 4 pins	Light-on	Alarme de stabilité

Remarque: la présence d'un suffixe supplémentaire indique une version révisée ou une version spéciale.

Les exploitants des produits que nous fournissons sont tenus d'assurer des mesures adéquates de protection des personnes. L'utilisation de nos appareils dans des applications comportant un risque possible pour la sécurité des personnes n'est admissible que si l'exploitant observe et met en œuvre des mesures séparées, appropriées et nécessaires pour la protection des personnes et des machines. Sous réserve de modifications et de possibilités de livraison.

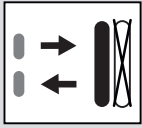

250 mm

- ✓ Kurzes M18 Gehäuse
- ✓ Empfindlichkeitseinstellung via Potentiometer
- ✓ IO-Link
- ✓ Exzellentes Schwarzweiss-Verhalten
- ✓ Immunität zu gegenseitigen Beeinflussungen

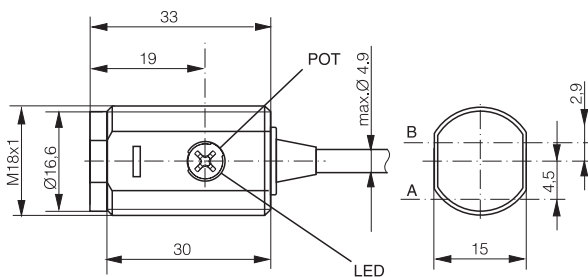
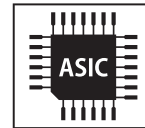

A: Senderachse B: Empfängerachse

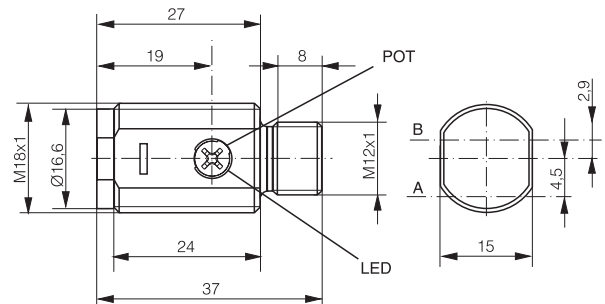

A: Senderachse B: Empfängerachse

OPTISCHE DATEN		INTERFACE	
Erfassungsbereich typ. max.	10...250 mm ¹	Empfindlichkeitseinstellung	30...250 mm, 3/4-Gang-Pot.
Arbeitsbereich	15...210 mm ¹	Anzeige-LED, grün	Funktionsreserve
Lichtquelle	Pinpoint LED, rot 640 nm	Anzeige-LED, gelb	Erfassungsstatus
Lichtfleckgrösse (Entfernung)	Ø 6 mm (100 mm)/Ø 10 mm (250 mm)	IO-Link	✓
		MTTF (@ 40°C)	554 y

¹Objekt mit 90% Reflexion (Standard-Weiss Papier)

ELEKTRISCHE DATEN		MECHANISCHE DATEN	
Versorgungsspannung (U _b)	10...30 VDC	Schutzart	IP67
Restwelligkeit	≤ 10 Vpp	Umgebungstemperatur Betrieb	-25...+65°C
Ausgangsstrom	≤ 200 mA	Schocks und Vibrationen	IEC 60947-5-2
Ausgangsspannung high/low (PNP)	≤ (U _b -2.0 V)/ ca. 0 V	Gewicht (Steckerversion)	6 g
Ausgangsspannung high/low (NPN)	ca. U _b / ≤ 2.0 V	Gewicht (Kabelversion)	71 g
Stromaufnahme (ohne Last)	≤ 30 mA	Gehäusematerial	ABS
Ansprechzeit ¹	≤ 700 µs (normal)/≤ 1.1 ms/≤ 500 µs	Fenstermaterial	PMMA
Schaltfrequenz ¹	≤ 700 Hz (normal)/≤ 450 Hz/≤ 1 kHz	Anschlusskabel	PVC, 2 m, 3- oder 4-adrig
Kurzschlusschutz	✓	Anschlussstecker	M12 4-Pin
Verpolungsschutz	✓	Max. Anzugsdrehmoment	1 Nm

¹Standardmässig im "Normal"-Modus. "Fine"- und "Fast"-Modus wählbar über IO-Link.

HINTERGRUNDVERSCHIEBUNG

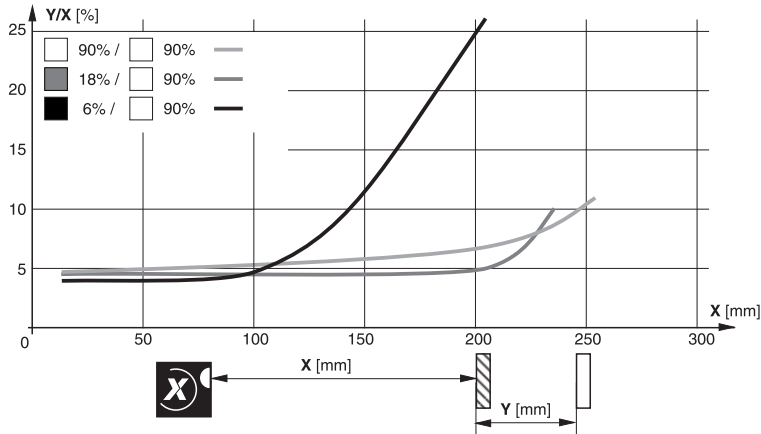

IO-LINK-FUNKTIONALITÄTEN

AUSGANG STABILITÄTSALARM (A2)

IO-Link-Version	1.0
SIO-Modus	Unterstützt
Prozessdaten	Erfassungsstatus u. Stabilitätsalarm
Baudrate	COM2 (38.4 kBaud)
Sonderfunktionen	Ausgang Konfiguration, Schaltverzögerung, Sensormodus, Erfassungs-counter, Event-Flags, maximale u. aktuelle Sensortemperatur

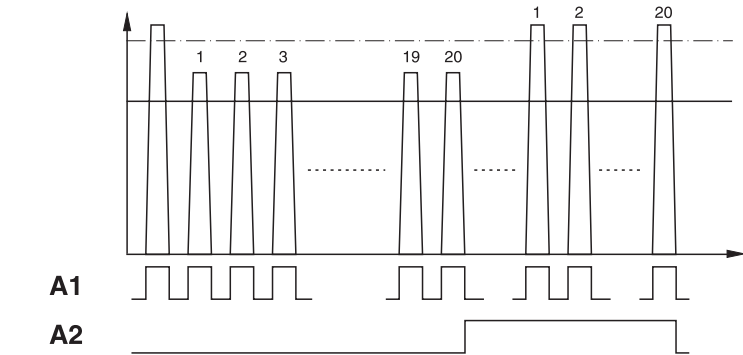

IO-Link-Spezifikationen und IODD-Dateien werden von www.contrinx.com heruntergeladen (Register Download)

ANSCHLUSSSCHEMA

STECKERBELEGUNG

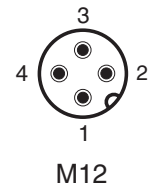
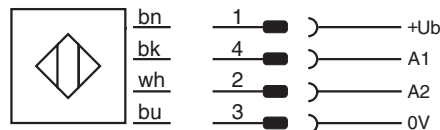
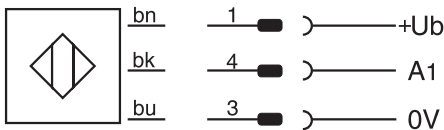

VERFÜGBARE TYPEN

Artikelnummer	Bezeichnung	Schaltung	Anschluss	Ausgang (A1)	Ausgang (A2)
620 600 208	LHR-M18PA-PMK-403	PNP	PVC, 2 m, 3-adrig	Hellschaltend/IO-Link	-
620 600 209	LHR-M18PA-PMK-603	PNP	PVC, 2 m, 4-adrig	Hellschaltend/IO-Link	Dunkelschaltend
620 600 210	LHR-M18PA-PMK-60C	PNP	PVC, 2 m, 4-adrig	Hellschaltend/IO-Link	Stabilitätsalarm
620 600 211	LHR-M18PA-PMK-301	NPN	PVC, 2 m, 3-adrig	Hellschaltend	-
620 600 212	LHR-M18PA-PMK-101	NPN	PVC, 2 m, 4-adrig	Hellschaltend	Dunkelschaltend
620 600 213	LHR-M18PA-PMK-10A	NPN	PVC, 2 m, 4-adrig	Hellschaltend	Stabilitätsalarm
620 600 214	LHR-M18PA-PMS-403	PNP	Stecker M12 4-Pin	Hellschaltend/IO-Link	-
620 600 215	LHR-M18PA-PMS-603	PNP	Stecker M12 4-Pin	Hellschaltend/IO-Link	Dunkelschaltend
620 600 216	LHR-M18PA-PMS-60C	PNP	Stecker M12 4-Pin	Hellschaltend/IO-Link	Stabilitätsalarm
620 600 217	LHR-M18PA-PMS-301	NPN	Stecker M12 4-Pin	Hellschaltend	-
620 600 218	LHR-M18PA-PMS-101	NPN	Stecker M12 4-Pin	Hellschaltend	Dunkelschaltend
620 600 219	LHR-M18PA-PMS-10A	NPN	Stecker M12 4-Pin	Hellschaltend	Stabilitätsalarm

Hinweis: Im Fall einer überarbeiteten Version oder Sonderausführung kann die Bezeichnung auch durch eine Endung ergänzt werden.

Die Einhaltung der Personenschutzmaßnahmen obliegt dem Betreiber der von uns gelieferten Produkte. Der Einsatz unserer Geräte in Anwendungen, bei welchen die Sicherheit von Personen gefährdet sein könnte, ist nur dann zulässig, wenn der Betreiber gesonderte geeignete und notwendige Maßnahmen für die Personen- und Maschinensicherheit einhält und vornimmt. Änderungen und Liefermöglichkeiten vorbehalten.