

1200 mm

- ✓ C23 Metal housing
- ✓ IO-Link
- ✓ Immunity to mutual interferences

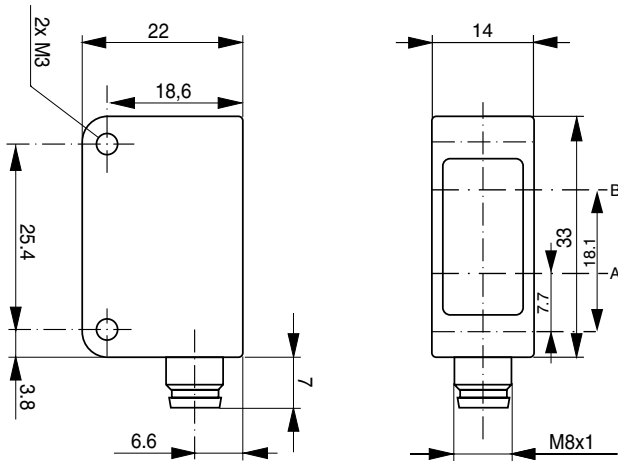
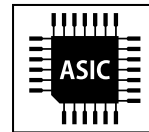
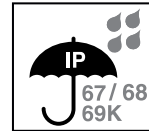

A: emitter axis B: receiver axis

OPTICAL DATA		INTERFACE	
Sensing distance	110% S_d	Output on pin 4	SIO Selectable / IO-Link
Operating distance (S_d)	5 ... 1200 mm ¹	Output on pin 2	SIO Selectable
Sensitivity adjustment	Depend on teach domain	Output Polarity	PNP
Light source	LED, red 630 nm	IO-Link	✓
Light spot size (distance)	Ø 11 mm (500 mm) / Ø 21 mm (1 m)		
Temperature drift (0 ... 0.8 S_d)	≤ % S_d		

¹ Object with 90% reflectance (standard white paper)

ELECTRICAL DATA		MECHANICAL DATA	
Supply voltage range (U_B)	10 ... 30 VDC	Enclosure rating	IP67 / 68 / 69K
Residual ripple	≤ 10% Vpp	Ambient temperature operation	-25 ... +65°C
Output current	≤ 100 mA	Shock and vibration	IEC 60947-5-2
Signal PNP high/low	≤ (U_B - 2.0 V) / approx. 0 V	Weight (connector version)	20 g
Power consumption (no load)	≤ 25 mA	Housing material	Stainless steel V2A
Response time	≤ 1 ms	Window material	PMMA
SIO Switching frequency	≤ 1000 Hz	Connector type	M8 4-pin
Short circuit protection	✓	Max tightening torque	2Nm
Voltage reversal protection	✓		
Cable length max.	≤ 20 m (IO-Link) / ≤ 300 m (SIO)		

SENSING RANGE

Target	Operating range
90%	5 ... 1200 mm
18%	15 ... 500 mm
6%	40 ... 300 mm

EXCESS GAIN

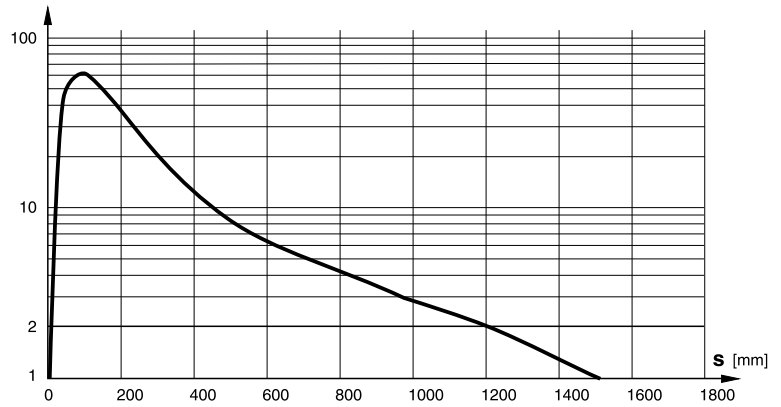

WIRING DIAGRAM

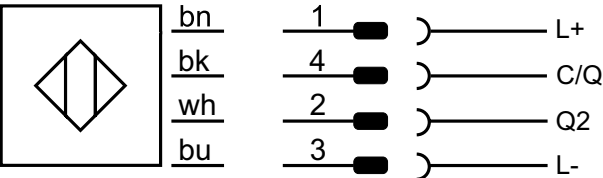

PIN ASSIGNMENT

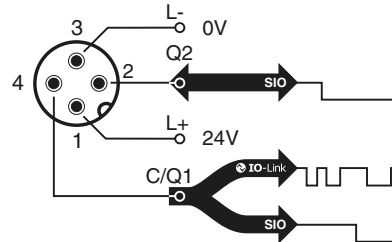

IO-LINK CHARACTERISTICS	VALUE FOR ISTR-M18MP-NMS-A0
Vendor ID	0156 _n
Device ID	A0301 _n
IO-Link Protocol	1.1
SIO-Mode	Supported
Process data	1 byte input / 1 byte output
Baudrate	COM2 (38.4 kBaud)
Minimum cycle time	4 ms



IODD files may be downloaded from
<https://www.contrinex.com/en-ch/collections/smart-photoelectric-basic>
 Select the product name to display the product page with corresponding downloads.
 Alternatively, just click/scan the QR code on the left.

AVAILABLE TYPES

Part number	Part reference	Operating range	Switching Frequency SIO
620-600-621	ISTR-C23MP-NMS-A0	5...1200mm	≤ 1000 Hz

Note: additional suffix can appear to indicate a revision version or a special version.

Operators of the products we supply are responsible for compliance with measures for the protection of persons. The use of our equipment in applications where the safety of persons might be at risk is only authorized if the operator observes and implements separate, appropriate and necessary measures for the protection of persons and machines. Terms of delivery and rights to change design reserved.

CONFIGURATION PARAMETER (IO-LINK / SIO MODE)

Index	Sub Hex	Name	Access	Data Type	Value	Default
SYSTEM						
02 _h	00 _h	System Command ⁽¹⁾	W	uint8	80 _h = Device Reset 81 _h = Application Reset 83 _h = Back-To-Box AA _h = Teach Domain Near 7E _h = Locator Start 7F _h = Locator Stop 05 _h = ParamDownloadStore 40 _h = Teach Apply 41 _h = Single Value Teach SP1 42 _h = Single Value Teach SP2 43 _h = Two Value Teach SP1 TP1 44 _h = Two Value Teach SP1 TP2 45 _h = Two Value Teach SP2 TP1 46 _h = Two Value Teach SP2 TP2 47 _h = Dynamic Teach SP1 Start 48 _h = Dynamic Teach SP1 Stop 49 _h = Dynamic Teach SP2 Start 4A _h = Dynamic Teach SP2 Stop 4F _h = Teach Cancel Abort	N/A
DATA STORAGE						
03 _h	01 _h	DS_Command ⁽¹⁾	R/W	uint8	00 _h : Reserved 01 _h : DS_UploadStart 02 _h : DS_UploadEnd 03 _h : DS_DownloadStart 04 _h : DS_DownloadEnd 05 _h : DS_Break 06 _h – FF _h : Reserved	N/A
	02 _h	State_Property ⁽¹⁾	R	uint8	Bit 0: Reserved Bit 1 and 2: State of Data Storage (00 _h : Inactive, 01 _h : Upload, 02 _h : Download, 03 _h : Data Storage Locked) Bit 3 to 6: Reserved Bit 7: DS_UPLOAD_FLAG (00 _h : no DS_UPLOAD_ FLAG, 01 _h : DS_UPLOAD_REQ pending)	N/A
	03 _h	Data_Storage_Size	R	uint32	–	N/A
	04 _h	Parameter_Checksum	R	uint32	–	N/A
	05 _h	Index_List	R	array of byte	–	N/A
PROFILE PARAMETER						
0D _h	–	Profile Characteristic	R	array	<ProfileID1>, <ProfileID2>, .. <FCID> (Type 2.7) (AdSS), 0x000E, 0x4000, 0x800C, 0x8011, 0x8012, 0x8101	–
PD DESCRIPTOR						
0E _h	–	PD Input Descriptor	R	array	(Type 2.7) (AdSS) <DataType><TypeLength><Bit offset> – [01] _h [08] _h [00] _h	–
0F _h	–	PD Output Descriptor	R	array	(Type 2.7) (AdSS) <DataType><TypeLength><Bit offset> [01] _h [01] _h [00] _h [02] _h [07] _h [01] _h	–
FUNCTION CLASS – IDENTIFICATION (8000_h)						
10 _h	–	Vendor Name	R	char [16]	“Contrinex AG”	–
11 _h	–	Vendor Text	R	char [32]	“www.contrinex.com”	–
12 _h	–	Product Name	R	char [32]	ISTR-C23MP-NMS-A0	–
13 _h	–	Product ID	R	char [16]	620-600-621	–
14 _h	–	Product Text	R	char [32]	AdSS photoelectric sensor	–
15 _h	–	Serial Number	R	char [16]	123456	–
16 _h	–	Hardware Revision	R	char [16]	1.0.0	–
17 _h	–	Firmware Revision	R	char [16]	1.0.0	–
18 _h	–	Application Specific Tag	R/W	char [32]	<user string, 32 bytes (variable length)>	<vendor specific>

⁽¹⁾This parameter is stored in a volatile memory

FUNCTION & LOCATION TAG

19 _h	–	Function Tag	R/W	char [32]	<user string, 32 bytes (variable length)>	***
1A _h	–	Location Tag	R/W	char [32]	<user string, 32 bytes (variable length)>	***

FUNCTION CLASS – DIAGNOSIS (8003_h)

24 _h	00 _h	Device Status ⁽¹⁾	R	uint8	0 = Device is OK, 1 = Maintenance required, 2 = Out of specification, 3 = Functional check, 4 = Failure, 5 ... 255 Reserved	–
25 _h	00 _h	Detailed Device Status ⁽¹⁾	R	array	1800 _h / EMC disturbance 1801 _h / Under IOL voltage 1803 _h / Short circuit 1804 _h / Under voltage 1805 _h / Disturbances on receiver 1806 _h / LED regulation limit 180C _h / Temperature limit	–

FUNCTION CLASS – TEACH-IN CHANNEL SELECT (8004_h)

3A _h	–	Teach Select ⁽¹⁾	R/W	uint8	00 _h : Default (SSC1) 01 _h : SSC1 02 _h : SSC2 FF _h : ALL	00 _h
-----------------	---	-----------------------------	-----	-------	---	-----------------

FUNCTION CLASS – TEACH STATUS (8007_h TO 8009_h)

3B _h	01 _h	Teach State ⁽¹⁾	R	bool[4]	0 _h = IDLE 1 _h = SP1 SUCCESS 2 _h = SP2 SUCCESS 3 _h = SP12 SUCCESS 4 _h = WAIT FOR COMMAND 5 _h = BUSY 6 _h = Reserved 7 _h = ERROR 8 _h ...11 _h = Reserved 12 _h ...15 _h = Vendor specific	00 _h
	02 _h	Flag SP1 → TP1 ⁽¹⁾	R	bool	00 _h : Teach point not taught or not successful 01 _h : Teach point successfully taught	00 _h
	03 _h	Flag SP1 → TP2 ⁽¹⁾	R	bool	00 _h : Teach point not taught or not successful 01 _h : Teach point successfully taught	00 _h
	04 _h	Flag SP2 → TP1 ⁽¹⁾	R	bool	00 _h : Teach point not taught or not successful 01 _h : Teach point successfully taught	00 _h
	05 _h	Flag SP2 → TP2 ⁽¹⁾	R	bool	00 _h : Teach point not taught or not successful 01 _h : Teach point successfully taught	00 _h

SCU – SENSOR CONFIGURATION UNIT

40 _h	01 _h	Sensor Startup Time	R/W	uint16	0 ... 65535 ms	0000 _h
	02 _h	Sensor Mode	R/W	uint8	00 _h : Fast 02 _h : Medium 24 _h : Fine	00 _h
	03 _h	Gain Value	R	uint16	–	–
	0C _h	Domain Teach Status	R	uint8_t	0 = Teach Domain Ok 1 = Saturation of Domain Detected	00 _h

SSC1 PARAMETER

3C _h	01 _h	Setpoint 1	R/W	uint32	Recommended value: (2234 ... 14894 = 15% S _d to 100% S _d)	100% S _d
	02 _h	Setpoint 2	R/W	uint32	Recommended value: (2234 ... 14894 = 15% S _d to 100% S _d), but must be lower than Setpoint 1. N/A if Single-Point mode is selected.	0% S _d

SSC1 CONFIGURATION

3D _h	01 _h	Logic	R/W	uint8	00 _h : High active 01 _h : Low active	00 _h
	02 _h	Mode	R/W	uint8	00 _h : Deactivated 01 _h : Single Point 02 _h : Window Mode 03 _h : Two Points	01 _h

⁽¹⁾ This parameter is stored in a volatile memory

	03 _h	Hysteresis Width	R/W	uint32	0 ... 16383 (e.g. If SSC1 Configuration Mode = Single Point, SP1 = 50% S _d = 7447, Hysteresis Width = 10% of SP = 745)	8% of S _d
	04 _h	Hysteresis Selection	R/W	uint8	0 = User Hysteresis 1 = Internal Hysteresis	

SSC2 PARAMETER

3E _h	01 _h	Setpoint 1	R/W	uint32	Recommended value: (2234 ... 14894 = 15% S _d to 100% S _d)	80% S _d
	02 _h	Setpoint 2	R/W	uint32	Recommended value: (2234...14894 = 15% S _d to 100% S _d), but must be lower than Setpoint 1. N/A if Single-Point mode is selected.	0% S _d

SSC2 CONFIGURATION

3F _h	01 _h	Logic	R/W	uint8	00 _h : High active 01 _h : Low active	00 _h
	02 _h	Mode	R/W	uint8	00 _h : Deactivated 01 _h : Single Point 02 _h : Window Mode 03 _h : Two Points	01 _h
	03 _h	Hysteresis Width	R/W	uint32	0 ... 16383 (e.g. If SSC1 Configuration Mode = Single Point, SP1 = 50% S _d = 7447, Hysteresis Width = 10% of SP = 745)	8% of S _d
	04 _h	Hysteresis Selection	R/W	uint8	0 = User Hysteresis 1 = Internal Hysteresis	

HYSTERESIS WIDTH RECOMMENDED BY CONTRINEX

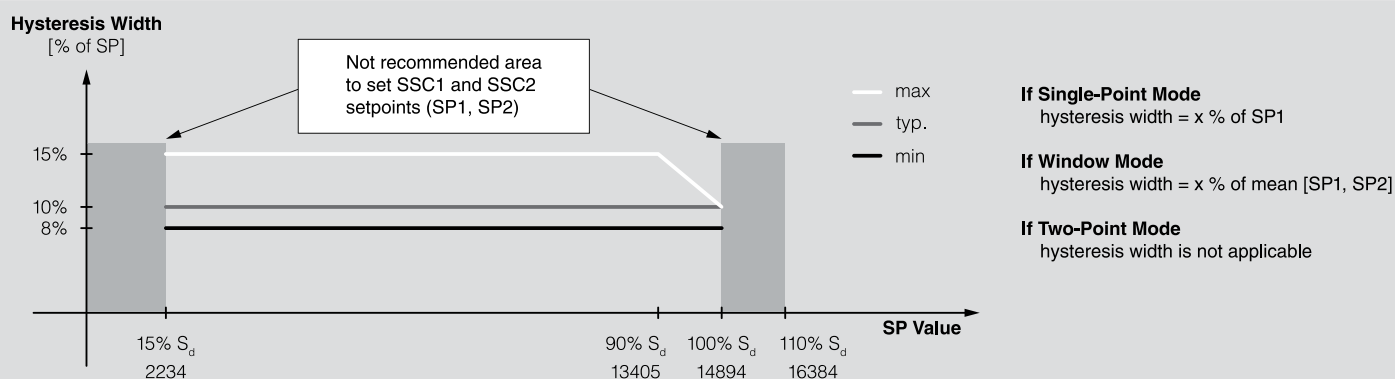

OSS CONFIGURATION

42 _h	01 _h	OSS1 Logic – Sensor Physical Output 1 Logic (PIN4) when used in SIO mode	R/W	uint8	0 = OUTPUT: High active (NO) 1 = OUTPUT: Low active (NC) 2 = OUTPUT: ON 3 = OUTPUT: OFF	00 _h
	02 _h	OSS2 Logic – Sensor Physical Output 2 Logic (PIN2) when used in SIO mode	R/W	uint8	0 = OUTPUT: High active (NO) 1 = OUTPUT: Low active (NC) 2 = OUTPUT: ON 3 = OUTPUT: OFF 4 = INPUT 5 = INPUT-TRIGGER Single Value Teach	00 _h
	03 _h	OSS1 Condition – Sensor Physical Output 1 Condition (PIN4) when used in SIO mode	R/W	uint8	0 = OSS1_A1 1 = OSS1_A1 AND OSS1_A2 2 = OSS1_A1 OR OSS1_A2 3 = OSS1_A1 XOR OSS1_A2	00 _h
	04 _h	OSS2 Condition – Sensor Physical Output 2 Condition (PIN2) when used in SIO mode	R/W	uint8	0 = OSS2_A1 1 = OSS2_A1 AND OSS2_A2 2 = OSS2_A1 OR OSS2_A2 3 = OSS2_A1 XOR OSS2_A2	00 _h

	05 _h	OSS1 Source A1 – Sensor Physical Output 1 Source A1 (PIN4) when used in SIO mode	R/W	uint8	0 = SSC1 1 = SSC2 2 = TSSP 3 = ALR1 4 = ALR2 5 = ALR3 6 = INPUT ⁽¹⁾ 7 = Not INPUT ⁽¹⁾	00 _h
	06 _h	OSS1 Source A2 – Sensor Physical Output 1 Source A2 (PIN4) when used in SIO mode	R/W	uint8	0 = SSC1 1 = SSC2 2 = TSSP 3 = ALR1 4 = ALR2 5 = ALR3 6 = INPUT ⁽¹⁾ 7 = Not INPUT ⁽¹⁾	00 _h
	07 _h	OSS2 Source A1 – Sensor Physical Output 2 Source A2 (PIN2) when used in SIO mode	R/W	uint8	0 = SSC1 1 = SSC2 2 = TSSP 3 = ALR1 4 = ALR2 5 = ALR3	00 _h
	08 _h	OSS2 Source A2 – Sensor Physical Output 2 Source A2 (PIN2) when used in SIO mode	R/W	uint8	0 = SSC1 1 = SSC2 2 = TSSP 3 = ALR1 4 = ALR2 5 = ALR3	00 _h

TMU – SENSOR TIMER UNIT

43 _h	01 _h	Timer Mode	R/W	uint8	0 = No Timer 1 = Stretch ON 2 = Delay ON 3 = Delay and Stretch ON 4 = One Shot	00 _h
	02 _h	Timer Value	R/W	uint16	0... 65535 ms	0000 _h
	03 _h	Timer Source	R/W	uint8	0 = SSC1 1 = SSC2 2 = ALR1 3 = ALR2 4 = ALR3	00 _h

CTU – SENSOR COUNTER UNIT

44 _h	01 _h	Counter Mode	R/W	uint8	0 = Falling Edge 1 = Rising Edge 2 = Both	00 _h
	02 _h	Counter Value ⁽²⁾	R/W	uint16	0... 65535	0000 _h
	03 _h	Counter Source	R/W	uint8	0 = SSC1 1 = SSC2 2 = TSSP 3 = ALR1 4 = ALR2 5 = ALR3	00 _h
	04 _h	Counter Reset Source	R/W	uint8	0 = ALR1 1 = ALR2 2 = ALR3	01 _h

SMU – SENSOR MONITOR UNIT

46 _h	01 _h	Current Temperature ⁽¹⁾	R	uint16	–	0000 _h
	02 _h	Max. Lifetime Temperature	R	uint16	–	0000 _h
	03 _h	Min. Lifetime Temperature	R	uint16	–	0000 _h
	04 _h	Lifetime Temperature Cycle Count	R	uint8	–	00 _h
	05 _h	Lifetime Operating Hours	R	uint32	–	00000000 _h
	06 _h	Lifetime Power-On Cycles	R	uint32	–	00000000 _h
	07 _h	Lifetime EMC Disturbances	R	uint32	–	00000000 _h

⁽¹⁾ Only available if OSS2 Logic = 4 = INPUT

⁽²⁾ This parameter is stored in a volatile memory

	08 _h	EVENT FLAG ⁽¹⁾⁽²⁾	R	uint8	B1 Short circuit on output B2 EMC disturbances B3 Disturbances on receiver B4 LED regulation limit B5 Under voltage B6 Over temperature B7 Under temperature	00 _h
--	-----------------	------------------------------	---	-------	--	-----------------

SMAU – SENSOR MEASUREMENT ALARM UNIT

47 _h	01 _h	Sensor Alarm 1 Threshold	R/W	uint16	0 ... 110% S _d	10% S _d
	02 _h	Sensor Alarm 1 Hysteresis	R/W	uint16	–	5%
	03 _h	Sensor Alarm 1 Configuration	R/W	uint8	0 = Always OFF 1 = High Active 2 = High Active / IO-Link event generation	00 _h
	04 _h	Sensor Alarm 1 Source	R/W	uint8	0 = Distance 1 = Counter 2 = Temperature	00 _h
	05 _h	Sensor Alarm 2 Threshold	R/W	uint16	0 ... 65535	100
	06 _h	Sensor Alarm 2 Hysteresis	R/W	uint16	–	0000 _h
	07 _h	Sensor Alarm 2 Configuration	R/W	uint8	0 = Always OFF 1 = High Active 2 = High Active / IO-Link event generation	00 _h
	08 _h	Sensor Alarm 2 Source	R/W	uint8	0 = Distance 1 = Counter 2 = Temperature	01 _h
	09 _h	Sensor Alarm 3 Threshold	R/W	uint16	–25 ... 65°C	65°C
	10 _h	Sensor Alarm 3 Hysteresis	R/W	uint16	–	0000 _h
	11 _h	Sensor Alarm 3 Configuration	R/W	uint8	0 = Always OFF 1 = High Active 2 = High Active / IO-Link event generation	00 _h
	12 _h	Sensor Alarm 3 Source	R/W	uint8	0 = Distance 1 = Counter 2 = Temperature	02 _h

DEVICE CHARACTERISTIC

49 _h	01 _h	Profile Compatibility	R	char []	SSP 2.7 AdSS	–
	02 _h	Detection Range Max.	R	char []	Depends on sensor type	–
	03 _h	Supply Voltage Range (U _b)	R	char []	“10 ... 30 VDC”	–
	04 _h	Max. Output Current	R	char []	“≤ 200 mA”	–
	05 _h	Ambient Temperature Range (T _A)	R	char []	“–25 ... +65°C”	–
	06 _h	Storage Temperature Range (T _S)	R	char []	“–25 ... +65°C”	–
	07 _h	Enclosure Rating	R	char []	IP67/IP68/IP69K	–

LEDC - LED CONFIGURATION

4B _h	01 _h	Yellow ON - SIO	R/W	uint8	0 = OSS1 1 = OSS2 2 = OSS1 or OSS2 3 = OFF	0
	02 _h	Green ON - SIO	R/W	uint8	0 = POWER 1 = OFF	0
	03 _h	Blinking Alarm - SIO	R/W	uint8	0 = ALR1 or ALR2 or ALR3 1 = OFF	0
	04 _h	LED IO-Link	R/W	uint8	0 = Green STD IO-Link 1Hz 1 = Id mode Green 5Hz 2 = Same as SIO	0
		Blinking Alarm Short-circuit				

SEM - SENSOR ECO MODE

4C _h	01 _h	SEM - selection	R/W	uint8	0 = Always OFF 1 = Active - state LED	1
-----------------	-----------------	-----------------	-----	-------	--	---

⁽¹⁾This parameter is stored in a volatile memory

⁽²⁾A read on this subindex clear all flags

	02 _h	SEM - yellow LED	R/W	uint8	0 = Disabled 1 = Enabled	1
	03 _h	SEM - green LED	R/W	uint8	0 = Disabled 1 = Enabled	1
	04 _h	SEM - Emission Frequency	R/W	uint8	0 = Normal 1 = Middle 2 = Low	0
FUNCTION CLASS – MDC DESCRIPTION PARAMETER (8005_h)						
4080 _h	01 _h	Lower Limit	R	int32	Lower value measurement range, see range definition in table A.5. According to SSP ⁽¹⁾ , Table D.14 page 78.	0
	02 _h	Upper Limit	R	int32	Upper value measurement range, see range definition in table A.5. According to SSP ⁽¹⁾ , Table D.14 page 78.	0
	03 _h	Unit Code	R	uint16	See Unit table defined in table A.7. According to SSP ⁽¹⁾ , Table D.14 page 78.	0
	04 _h	Scale	R	int8	See Table B.2. According to SSP ⁽¹⁾ , Table D.14 page 78.	0

⁽¹⁾ https://io-link.com/share/Downloads/Smart-Sensor-Profile/IOL-Smart-Sensor-Profile-2ndEd_V1.1_Sep2021.zip

PROCESS DATA REPRESENTATION

PROCESS DATA STRUCTURE

PROCESS DATA INPUT

Bitoffset

Byte	7	6	5	4	3	2	1	0
0	ALR3	ALR2	ALR1	OSSC2	OSSC1	TSSP	SSC2	SSC1

Name	Value	Description
ALR3	0	Alarm 3 is OFF
	1	Alarm 3 is ON
ALR2	0	Alarm 2 is OFF
	1	Alarm 2 is ON
ALR1	0	Alarm 1 is OFF
	1	Alarm 1 is ON
OSS2	0	Output switching signal 2 is OFF
	1	Output switching signal 2 is ON
OSS1	0	Output switching signal 1 is OFF
	1	Output switching signal 1 is ON
TSSP	0	Timered selected signal is OFF
	1	Timered selected signal is ON
SSC2	0	Switching signal 2 is OFF
	1	Switching signal 2 is ON
SSC1	0	Switching signal 1 is OFF
	1	Switching signal 1 is ON

PROCESS DATA OUTPUT

Bitoffset

Byte	7	6	5	4	3	2	1	0
0	RFU							DIS

Name	Value	Description
DIS	0	Sensor is enabled
	1	Sensor is disabled

SMART SENSOR SIGNAL FLOWS

Sensor timer unit (TMU) parameter examples

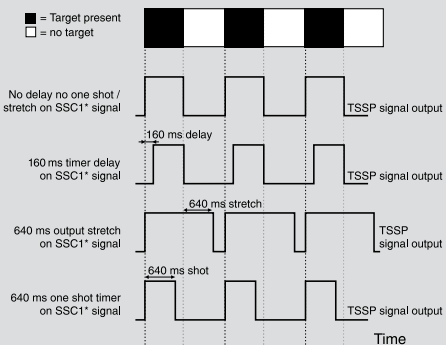

Event counter (pulse divider) example

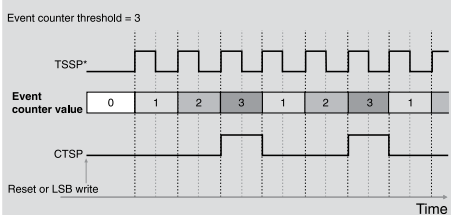

ERROR TYPES

Code	Additional code	Name	Description
80 _h	11 _h	Index Not Available	Access occurs to a not existing index
80 _h	12 _h	Subindex Not Available	Access occurs to a not existing subindex
80 _h	20 _h	Service Temporarily Not Available	Parameter is not accessible due to the current state of the device application
80 _h	21 _h	Service Temporarily Not Available – Local Control	Parameter is not accessible due to an ongoing local operation at the device
80 _h	22 _h	Service Temporarily Not Available – Device Control	Parameter is not accessible due to a remote triggered state of the device application
80 _h	23 _h	Access Denied	Write access on a read-only parameter
80 _h	30 _h	Parameter Value Out Of Range	Written parameter value is outside its permitted value range
80 _h	31 _h	Parameter Value Above Limit	Written parameter value is above its specified value range
80 _h	32 _h	Parameter Value Below Limit	Written parameter value is below its specified value range
80 _h	33 _h	Parameter Length Overrun	Written parameter length is above its predefined length
80 _h	34 _h	Parameter Length Underrun	Written parameter length is below its predefined length
80 _h	35 _h	Function Not Available	Written command is not supported by the device application
80 _h	36 _h	Function temporarily Not Available	Written command is not available due to the current state of the device
80 _h	40 _h	Invalid Parameter Set	Written single parameter collides with other actual parameter settings
80 _h	41 _h	Inconsistent Parameter Set	Parameter inconsistencies were found at the end of the block parameter transfer, device plausibility check failed
81 _h	02 _h	OSS1 source not available	First select OSS2 Logic = INPUT

EVENTS

Code	Type	Name	Description
1800 _h	Warning	EMC Disturbances	EMC Disturbances detected by sensor
1801 _h	Warning	Under IOL Voltage	Under IOL Voltage detected by sensor
1803 _h	Warning	Short Circuit	Short Circuit detected by sensor
1804 _h	Error	Under Voltage	Under Voltage detected by sensor
1805 _h	Warning	Disturbances on Receiver	Disturbances on Receiver detected by sensor
1806 _h	Warning	LED Regulation Limit	LED Regulation Limit detected by sensor
1808 _h	Notification	Alarm 1	Alarm 1 Threshold reached
1809 _h	Notification	Alarm 2	Alarm 2 Threshold reached
180A _h	Notification	Alarm 3	Alarm 3 Threshold reached
180B _h	Notification	Trigger Teach	New SSC value is taught
180C _h	Warning	Temperature Limit	Temperature limit reached

Operators of the products we supply are responsible for compliance with measures for the protection of persons. The use of our equipment in applications where the safety of persons might be at risk is only authorized if the operator observes and implements separate, appropriate and necessary measures for the protection of persons and machines. Terms of delivery and rights to change design reserved.