

Copy right reserved.
The manufacturer reserves the right to change specification of the products without notice.

Install & maintenance manual

ESR series soft starter

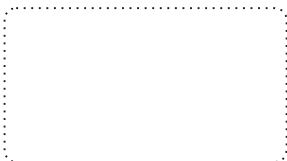

Low voltage product
SL19/03/10 VER 5.00

CATALOG

Content	page
Safety & Warning.....	1-2
General.....	3
Model description.....	4
Soft starter control and application.....	5-6
Installation.....	7
Wiring.....	8-11
Typical Application.....	12-13
Operation panel description.....	14
Parameter.....	15-18
Trouble shooting.....	19
Appendix.....	20
Mechanical installation.....	21
Typical wiring.....	22-26



Caution

Remind user caution information.



Warning

If not avoided, could result in damaged to the equipment.



Avoid electrostatic

Warning. It is forbidden to touch the PCB with the mark. Electrostatic charges could damage the components of soft starter.



High voltage warning

If not avoided, could result in damaged to the equipment and possible injury or death.

Safety & Warning



warning- Indicates a risk of electric shock.

High voltage are presents at the input and output terminals of SSR series soft starter, even not work when connect power supply. Only qualified electricians are allowed to install this products.



Do not carry out any work on the soft starter while the power is applied.

The installation electricians have the responsibility to ensure correct earthing connection. Do not connect the power factor correction capacitor to the output side of the SSR soft starter. If the static power factor compensation measures are to be taken, The related devices must be connected to the power supply side of the soft starter.

General

ESR series soft starter is a full digital product.
 Suitable for squirrel-cage asynchronous motors:
 Rated voltage: 200V-525V Rated power: 0.75-75KW
 The ESR series soft starter can control the motor to accelerate smoothly during the starting process and decelerate smoothly in the process of stopping. It also provides a comprehensive protection function for motors and itself.

Functions

- Start/stop slope and initial voltage set by 3 different potentiometers built-in
- Bypass relay built-in, No need for extra contactor
- Voltage slope with current limit mode. External
- Δ , Y Wiring mode
- Real-time data of communication(A,B,C phase current, average current) * 1
- Reading history fault records by communication (10 history log)*1
- The statistics data can be read by modbus communication.*1
- Protections:
 - 1) Overcurrent Protection. 2
 -) Undercurrent Protection.
 - 3) Over Load Protection with classes 10A, 10, 20 and 30.
 - 4) Three phase current unbalance Protection.
 - 5) Max start time protection.
 - 6) Phase Missing/No voltage Protection.
 - 7) Phase Sequence Protection.
 - 8) SCR Overheating Protection.

- 1 start/stop Digital Input
- Communication Interface. *1
- Option Build In start/stop switch *2
- 2 Output relay(running relay, trip relay)

Note *1: Option, only if select the RS-485 communication interface with the function. Note *2: The function is available by using optional ESR switch on operating panel.

Model description

Technical parameters

- Rated Main Voltage: 200-525VAC 50/60Hz
- Control Source Voltage: 100-240VAC 24VDC;
- Rated Main Current: 1.5A.....150A
- Initial voltage: 30%~70%;
- Start Slope: 1~30 Sec;
- Stop Slope: 0~30 Sec;
- Overload: 3xle 7 Sec, Valid for 50 % on time and 50 % off time.
- Times of start per hour: <5, 5-10 (light load or no-load)
- Overload grade: 10A;
- Operation Environmental temperature: 0 °C to + 50 °C (32 °F to 122 °F)
- Store temperature: -40 °C to + 70 °C (-40 °F to 158 °F)
- Maximum altitude: 1000m (3280 ft)
- Ingress Protection grade: IP21;

Model description

ES R - 40 22 - X - XXX - 1+2

R: Option1 With RS485 communication.
 S:Option2 Start Button On Panel

Soft Start Mode *4
 Control Source Voltage *3
 Rated Main Current *2
 Rated Main Voltage *1
 Product Series
 Company Title

※
 1、 Rated Main Voltage 22: 220V; 40 : 400V; 50: 500;
 2、 Rated Main Current 1.5-150A;
 3、 Control Source Voltage A: 100-240VAC; B: 24VDC;
 4、 Soft Start Mode: 3P3: Three-phase controlling ; 1P1: Single-phase controlling ;

Rated Main Current

Parameters (Type 3P3)

Model	Motor power rating			Rated current Ie A	Structure F	Weight kg
	220V Pe/kW	400V Pe/kW	500V Pe/kW			
ESRXX 1R5-X-3P3	0.37	0.75	1.1	1.5	A	1
ESRXX 2R2-X-3P3	0.55	1.1	1.5	2.2	A	1
ESRXX 03-X-3P3	0.75	1.5	2.2	3	A	1
ESRXX 4R5-X-3P3	1.1	2.2	3.7	4.5	A	1
ESRXX 7R5-X-3P3	1.5	3.7	5.5	7.5	A	1
ESRXX 11-X-3P3	2.2	5.5	7.5	11	A	1
ESRXX 15-X-3P3	3.7	7.5	11	15	B	1.4
ESRXX 22-X-3P3	5.5	11	15	22	B	1.4
ESRXX 30-X-3P3	7.5	15	18.5	30	C	2.4
ESRXX 37-X-3P3	11	18.5	22	37	C	2.4
ESRXX 45-X-3P3	15	22	30	45	C	2.4
ESRXX 60-X-3P3	18.5	30	37	60	C	2.4
ESRXX 75-X-3P3	22	37	45	75	C	2.4
ESRXX 90-X-3P3	25	45	55	90	D	5
ESRXX 110-X-3P3	30	55	75	110	D	5.2
ESRXX 150-X-3P3	37	75	90	150	D	5.2

※:1T5 means 1.5A, 4T5 means 4.5A, 7T5 means 7.5A in Rated current.

Soft starter control and application

Rated Main Current

Parameters (Type 1P1)

Model	Motor power rating		Rated current Ie A	Structure F	Weight kg
	220V Pe kW	400V Pe kW			
ESRXX02-X-1P1	0.37	0.55	2	A	1
ESRXX03-X-1P1	0.55	0.75	3	A	1
ESRXX04-X-1P1	0.75	1.1	4	A	1
ESRXX06-X-1P1	1.1	1.5	6	A	1
ESRXX09-X-1P1	1.5	2.2	9	A	1
ESRXX12-X-1P1	2.2	3.7	12	A	1
ESRXX20-X-1P1	3.7	5.5	20	A	1
ESRXX30-X-1P1	5.5	7.5	30	C	2.4
ESRXX37-X-1P1	7.5	11	45	C	2.4

Rated Main Voltage

The rated main voltage of ESR is 220V/400V/525V.
More detail please check the above-mentioned parameters.

Control Source Voltage

Code	Control Source Voltage
A	100~240VAC
B	24VDC

Internal Control Diagram

1、3P3(Only Use For Three Phase Motor);

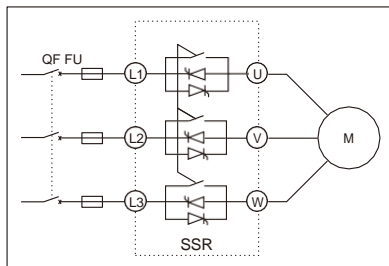

2、1P1(Only Use For Single Phase Motor);

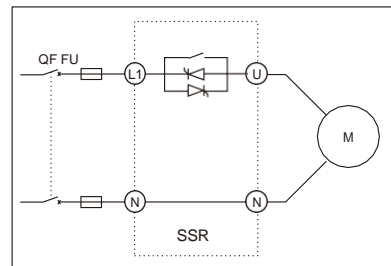

Soft starter control and application

Options

ESR Soft starter provides two options for users :

· communication option (option 1)

RS-485

The RS-485 option of soft starter can support MODBUS-RTU communication protocol.

· Build In start/stop switch (option 2)

The operation panel of soft starter can be equipped with start / stop switch, and users can use the switch to operate motor start / stop directly .

Model selection

For example : Choose a 400V, 7.5KW soft starter with control source voltage of 24VDC The type should be : ESR4015-B-3P3

If a built-in start / stop switch is needed

The type should be : ESR4015-B-3P3+2

If a communication option and built-in start / stop switch are needed The

type should be : ESR4015-B-3P3-1+2

Model selection specification

1) For ordinary loads

The corresponding ESR soft starter models can be selected according to the rated current of motors marked on the motor nameplate, such as pumps, compressors, etc.

2) For heavy load

ESR soft starter model of larger power size can be selected according to the rated current of motor nameplate, such as centrifuge, crushing machine, mixer, blender, etc.;

◆ Frequent start

For frequent starting loads. According to the rated current of the motor marked by the motor nameplate, we choose a higher power size ESR soft starter.

◆ Caution:

1) When the ambient temperature is higher than 40 degrees, the current rating increases by 1 degrees, and the current rating decreases by 0.8%.

2) When altitude is above 1000m, decrease as below:

$$I_n = 100 - \frac{x-1000}{150}$$

When the altitude is 2000m:

$$I_n = 100 - \frac{2000-1000}{150} = 93.3\%$$

The rated current capacity of soft starter should decrease to 93.3% of nominal current.

Installation

Mechanical installation (The method of installation)



Usually we suggest that the soft starter should be installed vertically, which is good for heat dissipation.



When two or more than two soft starters are installed vertically stacked, the distance between soft starters is not less than 100mm.

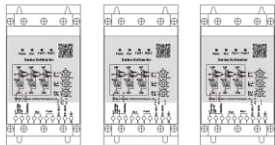

When two or more than two soft starters are installed horizontally side by side, the distance between soft starters is not less than 50mm.

Installation environment

Caution



- Do not install the soft starter near the heat source.
- Soft start must be reliably grounded, and avoid dust or corrosive environment.
- Working temperature under rating 0 °C to + 50 °C (32 °F to 122 °F)
- Relative humidity is less than 95%;

Installation environment

The rated loss power of the soft starter approximately about

Power Dissipation $\approx 3 \times I_e (W)$
 I_e —Motor Rated Current (A)
 Installed in a metal cabinet without ventilation
 Area (m²) > 0.12 x Power Dissipation

Wiring

Main Circuit

ESR soft starter support two kinds of wiring modes.

Wiring for three-phase motor

ESRXXXX-X-3P3-X+X Main circuit wiring diagram (3P3 soft starter)

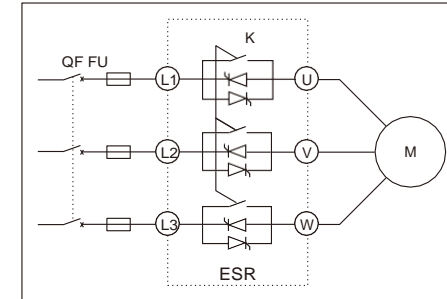

Wiring for single-phase motor

ESRXXXX-X-1P1-X+X Main circuit wiring diagram (1P1 soft starter)

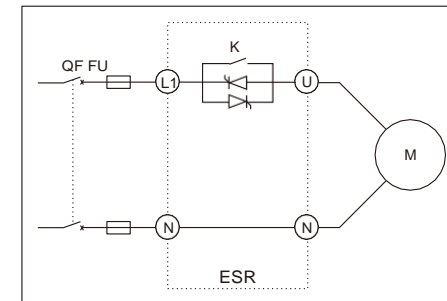

Caution



- QF Circuit breaker A circuit breaker with a tripping device is recommended.
- FU fuse Recommended installation, Selection of fuses based on SCR
 More detail in the appendix 11 on page 13.
- K Built-in By pass relay.
- M Motor.

Wiring



Caution

- Suggested that a circuit breaker with a tripping device is installed between input of the soft starter and the connection of the power source. The connection between the soft starter and the power source must be switch off before maintenance.

Main circuit terminal



Caution

- Suggested to use flame retardant copper core PVC insulated wire to connect main circuit.

Wiring

Main circuit terminal

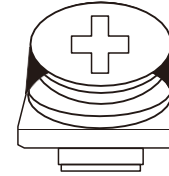

Main circuit terminal:
Recommended use: 6–50mm² AWG: 10–1/0
Recommended torque: 4N.m

Control terminal

Control terminal diagram

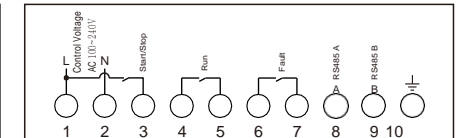
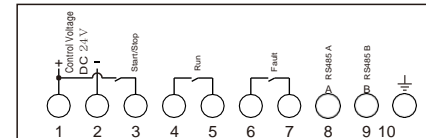

10 input / output terminals:

- ① Control power L or + input.
- ② Control power N or - input.
- ③ Start / Stop signal input. When terminal 3 is connected to terminal 1 the starter runs, When the terminal 3 and terminal 1 are disconnected, the stop softly until stop completely.
- ④ Running signal relay output.
When the soft start is in start, bypass and soft stop state, relay operation is closed.
- ⑤ Running relay output common.
- ⑥ Fault relay output. When the soft start is in a fault state, the relay is closed.
- ⑦ Fault relay output common.
- ⑧ RS-485 bus A-LINE.
- ⑨ RS-485 bus B-LINE.
- ⑩ Earthing terminal.

Wiring

Control power supply and control input

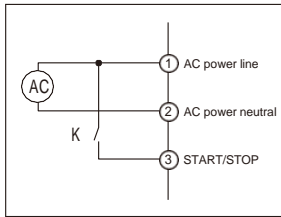

When using 100~240VAC as a control power,
 ①Connect AC power line, ②Connect AC power neutral;
 Join the contact K between ① and ③,
 Soft starter runs when K closed,
 soft starter stops when K disconnected;
 If the control input cable too long or unseparated wiring with
 power supply, cause input signal with "induced voltage" Please
 add a relay at the input, so as to avoid the " induced voltage "
 which leads to malfunction or damage of the
 soft starter.

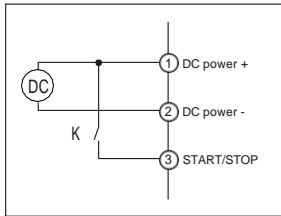

When using 24VDC as control power.
 ①connect to DC+, ② connect to DC-;
 Join the contact K between ① and ③,
 Soft starter runs when K closed, Soft starter stops when
 K disconnected; If the control input cable too long or
 unseparated wiring with power supply, cause input signal with
 "induced voltage" Please add a relay at the input, so as to avoid
 the " induced voltage " which leads to malfunction or damage of
 the soft starter.

Caution



- The control power supply voltage must be matched the products, otherwise the input of the control voltage will exceed the range, which will lead to soft starter damage.
- When the control power supply is DC power, the positive and negative pole must be connected to the correct terminal.

Relay output

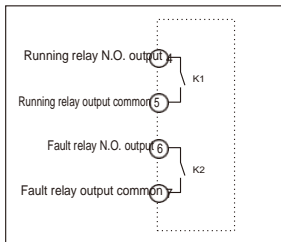

④, ⑤terminal for running relay output,
 When ESR soft starter is on running (start / bypass / soft stop), K1
 closes. ⑥ ⑦ terminal is fault relay output,
 When the ESR soft starter detects a fault, K2 closes.
 K1、K2 contact capacity 220VAC 5A

Caution



- In order to use the SSR soft starter safely, The fault relay K2 should be connected in the circuit of the control (release) of the circuit breaker between the power source and the SSR main power terminal. When the soft starter detects the fault, the K2 action can disconnect the power breaker at the same time.

Typical wiring

Y Wiring Mode

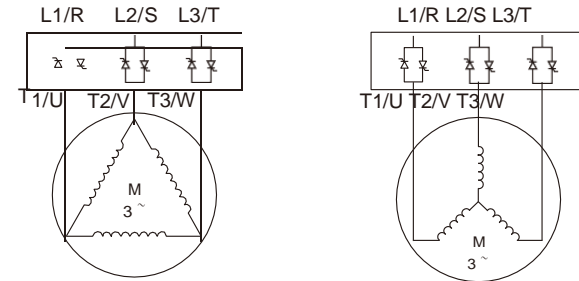

When using the external mode of ESR, the ESR power module is connected between the power source and the motor.

Caution



- The motors with three terminals can only use the external wiring mode.
 The rated current of the soft starter in the external mode is selected according to the rated current of the motor.

Typical wiring

ESR soft starter rated current

Model	Motor power rating			Rated current Ie A	Structure F	Weight kg
	220V Pe/kW	400V Pe/kW	500V Pe/kW			
ESRXX 1T5-X-3P3	0.37	0.75	1.1	1.5	A	1
ESRXX 2T2-X-3P3	0.55	1.1	1.5	2.2	A	1
ESRXX 03-X-3P3	0.75	1.5	2.2	3	A	1
ESRXX 4T5-X-3P3	1.1	2.2	3.7	4.5	A	1
ESRXX 7T5-X-3P3	1.5	3.7	5.5	7.5	A	1
ESRXX 11-X-3P3	2.2	5.5	7.5	11	A	1
ESRXX 15-X-3P3	3.7	7.5	11	15	B	1.4
ESRXX 22-X-3P3	5.5	11	15	22	B	1.4
ESRXX 30-X-3P3	7.5	15	18.5	30	C	2.4
ESRXX 37-X-3P3	11	18.5	22	37	C	2.4
ESRXX 45-X-3P3	15	22	30	45	C	2.4
ESRXX 60-X-3P3	18.5	30	37	60	C	2.4
ESRXX 75-X-3P3	22	37	45	75	C	2.4
ESRXX 90-X-3P3	25	45	55	90	D	5
ESRXX 110-X-3P3	30	55	75	110	D	5.2
ESRXX 150-X-3P3	37	75	90	150	D	5.2

Fuse table



Model	SCR ¹ T(A ² S)	Fuse Value
SSRXX 1T5-X-3P3	70	5A
SSRXX 2T2-X-3P3	150	10A
SSRXX 03-X-3P3	270	10A
SSRXX 4T5-X-3P3	610	16A
SSRXX 7T5-X-3P3	1700	25A
SSRXX 11-X-3P3	3630	32A
SSRXX 15-X-3P3	5000	40A
SSRXX 22-X-3P3	7500	50A
SSRXX 30-X-3P3	10000	63A
SSRXX 37-X-3P3	11000	100A
SSRXX 45-X-3P3	12000	160A
SSRXX 60-X-3P3	15000	200A
SSRXX 75-X-3P3	18000	250A
SSRXX 90-X-3P3	40000	315A
SSRXX 110-X-3P3	60000	315A
SSRXX 150-X-3P3	100000	400A

Caution



- Using semiconductor protection fuse can achieve 2nd standard, and reduce the risk of power module damage caused by transient overload current.
- 2nd standard: Under the condition of short circuit, the short circuit protection electric does not cause harm to the personal and installation equipment, and it can continue to be used.

Operation interface description

ESR soft starter panel diagram

- 1) State display LED: Show the working state of the soft starter.

power (green)	When the soft starter is power on, the power supply LED on.
Run (yellow)	When the soft starter (motor) stop, running LED off.
	When soft starter (motor) is in soft start / soft stop state, running LED blink.
	When the soft starter (motor) is in bypass state, running LED on
Fault 1 (red)	When the soft starter is in fault state, fault LED blink or on.
Fault 2 (red)	More details please check the page 19.

- 2) Potentiometer setting

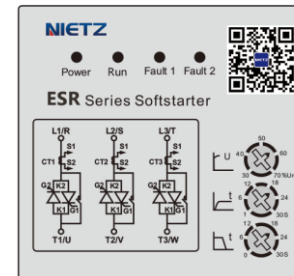

Adjustable potentiometer

Initial voltage Set initial voltage

Start Slope Set acceleration time

Stop Slope Set deceleration time

Parameter setting

The main starting / stopping parameters of ESR soft starter can be set by the panel potentiometer. Other parameters have been set up at factory commissioning, users do not need to set them. Other parameters can be adjusted by RS485 communication.

Parameter description

Main parameter

Parameter	Setting range	Default
FLC Full load current	1-1600A	Primary current of current transformer , factory setting

Parameter	Setting range	Default
FLA Full load current	1-1600A	Primary current of current transformer , according to rated current of soft starter factory setting

Protection parameters

Parameter	Setting range	Default
Over current protection value	200-600%FL A	450%FLA Factory setting

Parameter	Setting range	Default
Over current trip delay time	0~2.0Sec.	1Sec Factory setting



Caution

When the output current exceeds the over current protection set value (the motor rated current FLA 200-600%) the soft starter is delayed for a period of time ("over current action delay time" specified time) then trip, the fault relay (K2) tripped.

Parameter	Setting range	Default
Max start time	5~35Sec.	30Sec Factory setting

Parameter	Setting range	Default
Over load protection	100~200%	115%FLA Factory setting

Parameter	Setting range	Default
Overload protection grade	0-Grade 10A 1-Grade 10 2 -Grade 20 3 -Grade 30	0-Grade 10A Factory setting

Parameter description

Electronic overload and tripping curve

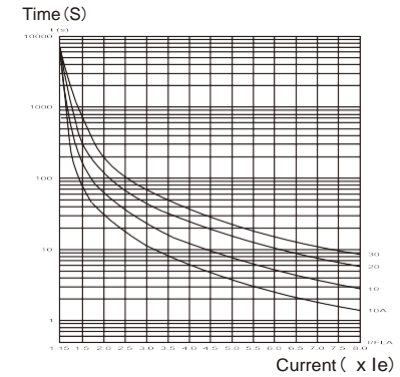

Caution



- Thermal protection of SSR motor. It is recommended that users set overload protection to (level 10A) , When the setting less than "overload protection value", the soft starter detect overload protection.

Parameter	Setting range	Default
Phase sequence protection	0- OFF 1- ON	1- ON

Parameter	Setting range	Default
Under current protection value	0-100%FLA	0

Parameter	Setting range	Default
Under current protection delay	0-60Sec	60Sec

Parameter description

Parameter	Setting range	Default
Unbalanced current protection value	10~50%FLA	30%FLA
Unbalanced current protection delay	0~25Sec	10Sec

The parameter setting protection functions not introduced above:



Caution

More protections of SSR:

- 1) Overtemp protection. When the heatsink temperature is above 75 degrees, the soft start trip.
- 2) When the soft starter input terminal/output terminal missing phase, the soft start trip.
- 3) When the power module is short circuited, soft start tripped.

Start / stop parameters

Parameter	Setting range	Default
Starting time	1-30 Sec.	Panel potentiometer setting or check the page 20.

Parameter	Setting range	Default
Stop time	0-30 Sec.	Panel potentiometer setting or check the page 20.

Parameter	Setting range	Default
Initial voltage	30-70%	Panel potentiometer setting or check the page 20.

Parameter	Setting range	Default
Current limit value	200-500%FL A	350%FLA



Caution

The initial voltage is set via the panel or communication.
 . When the initial turnMoment = initial voltage $2 \times T_N$ (T_N : rated torque)
 The current limit value is set via the communication(Modbus)

Parameter

Voltage slope with current limit mode

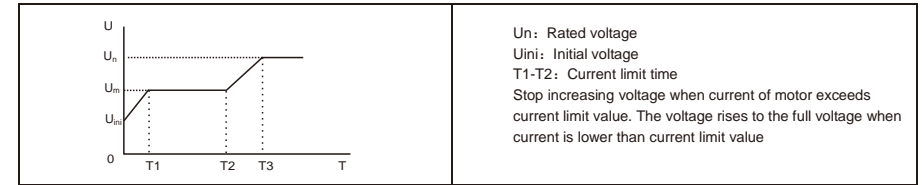

Caution

- The motor can't start(Locked-Rotor) if the voltage is too low. It is suggested that set initial voltage from high to low or use the Recommended setting.
- The process of start/stop is faster when motor is no-load.

Parameter setting list

Parameter	Setting range	Default
FLC Soft starter full load current	1~1600A	Factory setting
FLA Motor full load current	1~1600A	According to the power of soft starter.
Over current protection value	200%~600%FLA	450% FLA
Over current trip delay	0~2Sec	1 Sec.
Over load protection value	100~200%FLA	115% FLA
Overload protection grade	0-Grade 10A 1-Grade 10 2- Grade 20 3- Grade 30	0-Grade 10A
Phase sequence protection	0- OFF 1- ON	1-ON
Under current protection value	0~100%FLA	0
Under current protection delay	0~60Sec	60Sec.
Unbalanced current protection value	10~50%FLA	30%FLA
Unbalanced current protection delay	0~25Sec	10Sec.
Starting time	1~30 Sec	Panel potentiometer setting
Stop time	0~30Sec	Panel potentiometer setting
Initial voltage	30~70%FLA	Panel potentiometer setting
Current limit value	200~500%FLA	350%FLA
Max start time	5~35Sec	30Sec

Trouble shooting

Fault list

Fault	Fault reason	Not working	Start/stop process	Bypass
Phase sequence trip	The sequence of three phase voltage is wrong	×	√	×
Missing phase trip	Missing one phase or two phase voltage in three phase voltage	×	√	√
No voltage trip	NO voltage input	×	√	√
Over current trip	Current value exceeds over current setting value	√	√	√
Over load trip	Current value exceeds overloading set value	×	×	√
Unbalanced current trip	The unbalanced three-phase current is larger than the unbalanced current setting value	×	√	√
Overtemp trip	The temperature of the heatsink exceeds 75℃	√	√	√
Under current trip	Current value lower than under current set value during bypass	×	×	√
Max start time trip	The time of starting process exceeds the max start time value	×	√	×

Note: × : Not working; √ : working

Fault solution

Fault	Fault 1	Fault 2	Fault reason	Solution
Phase sequence trip	⊙	○	The sequence of three phase voltage is wrong	Change the sequence of three phase.
Missing phase trip/No voltage trip	○	⊙	Missing one phase or two phase voltage in three phase voltage /NO voltage input	The connection between the soft start and the main power supply is open.
Over current trip	○	●	Current value exceeding over current setting value	Check whether the connection between soft start and motor is short circuited.
Over load trip	●	○	Current value exceeds overloading set value	Check whether the load is too large or whether the selection of soft starter power is too small.
Unbalanced current trip	●	⊙	The unbalanced three-phase current is larger than the unbalanced current setting value	Check the winding of the motor and the connection between soft starter and motor
Overtemp trip	⊙	●	The temperature of theheatsink exceeds 75℃	Check whether the connection between soft start and motor is short circuited,Check whether the load is too large or whether the selection of soft starter power is too small.
Under current trip	●	●	Current value lower than under current set value during bypass	Check whether the load is too small like pump dry burning
Max start time trip	⊙	⊙	The time of starting process exceeds the max start time value	Check whether the parameters is reasonable, the load is too large or whether the selection of soft starter power is too small.

⊙ Blink; ● On; ○ OFF

- The frequency protection is built-in, ESR can work with 50/60HZ voltage.
- The single-phase soft starter have no unbalanced current trip, but have no voltage trip.

Appendix

Overload time

$$\text{Overload trip time} = \frac{1375000}{I\%^2 - 110^2} \times \frac{T_X}{6}$$

Among:

I% is the ratio of the actual current to the rated current tolerance time of T * 500% overload current (X=5)

Minimum overload tolerance time

Overload grade	Minimum overload tolerance time						
	X=8	X=7	X=6	X=5	X=4	X=3	X=2
10A	1.6	2	3	4	6	12	26
10	3	4	6	8	13	23	52
20	5	6	9	12	19	35	78
30	7	9	13	19	29	52	112

Common load and parameter setting

1) Slope starting mode

Load	Start time	Stop time	Initial voltage
Boat propeller	15	0	40%
Centrifugal fan	15	0	45%
Centrifugal pump	15	5	40%
Piston compressor	10	0	45%
Rotary converter	15	0	40%
Mixer	20	0	50%
Crusher	20	0	50%
Spiral air compressor	10	0	45%
No-load motor	20	0	30%
Band conveyer	15	0	50%
Hot water pump	15	5	45%
Air pump	15	0	40%

ESR1.5~11A
Model A

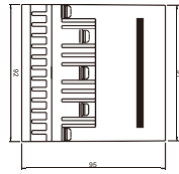

ESR15~22A
Model B

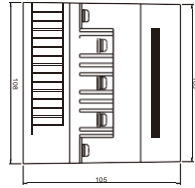

ESR30~75A
Model C

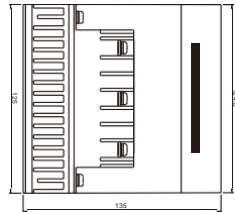

ESR90~150A
Model D

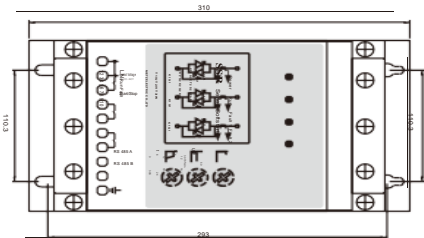
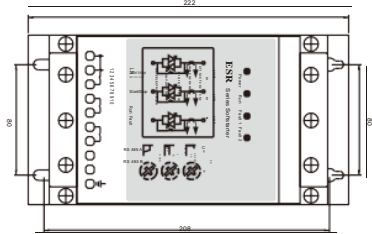
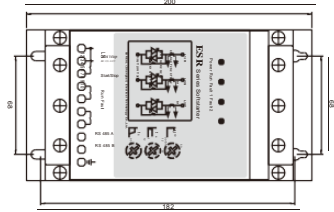
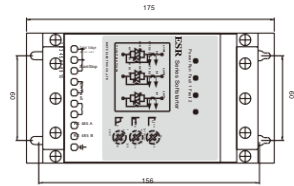
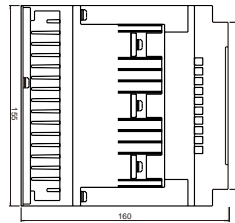

Dear customer:

After receiving the products sent by our company, please do not install and run directly. First, it should make a simple test according to the wiring drawings of experimental methods and steps provided by our company. After ensuring the operation of the soft starter, the wiring of the cabinet and motor correct. Then the test of whole system can be carried out.

Test steps:

1. Connect 3 200W/220V lamps (H1-H3) with Y connection then connect to the output of the soft starter U, V and W, and also can test by connect the small motor.
2. Close the QF1, connect the 380V AC to R, S and T of the soft starter's input terminal
3. Close the QF2 to make the 220V control power connect to the control terminals 1 and 2 of the soft starter.
4. Soft start: closed knob switch K1 (connect terminal 1, 3), bulb slowly lighten up. After the bulb is bright up, the bypass KM closes the soft start process.
5. Soft stop: disconnect K1 (disconnect terminal 1, 3), bypass KM disconnect, bulb slowly extinguish, after bulb is completely off, soft stop process is completed.

*If the above experimental steps can not be carried out normally, we can preliminarily judge that the soft starter has been damaged. For more details, please contact the technical service department.

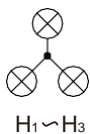
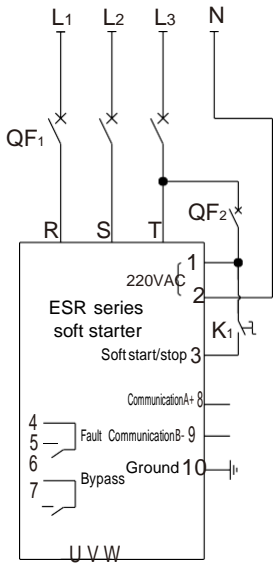

Technical service department:

Telephone : +86-21 33634649

E-mail: info@nietz.cn

Basic parameter setting	
Overload Trip	10
Start	8~12S
Stop	2~4S
UINI	50%

